

California High-Speed Rail Authority

San Jose to Merced Section: San Jose to Central Valley Wye

Composite Plan, Profile, and Cross Sections

Alternative 3 - Viaduct to East Gilroy
Draft EIR/S: Volume III
Preliminary Engineering for Project Definition
Record - May 2019

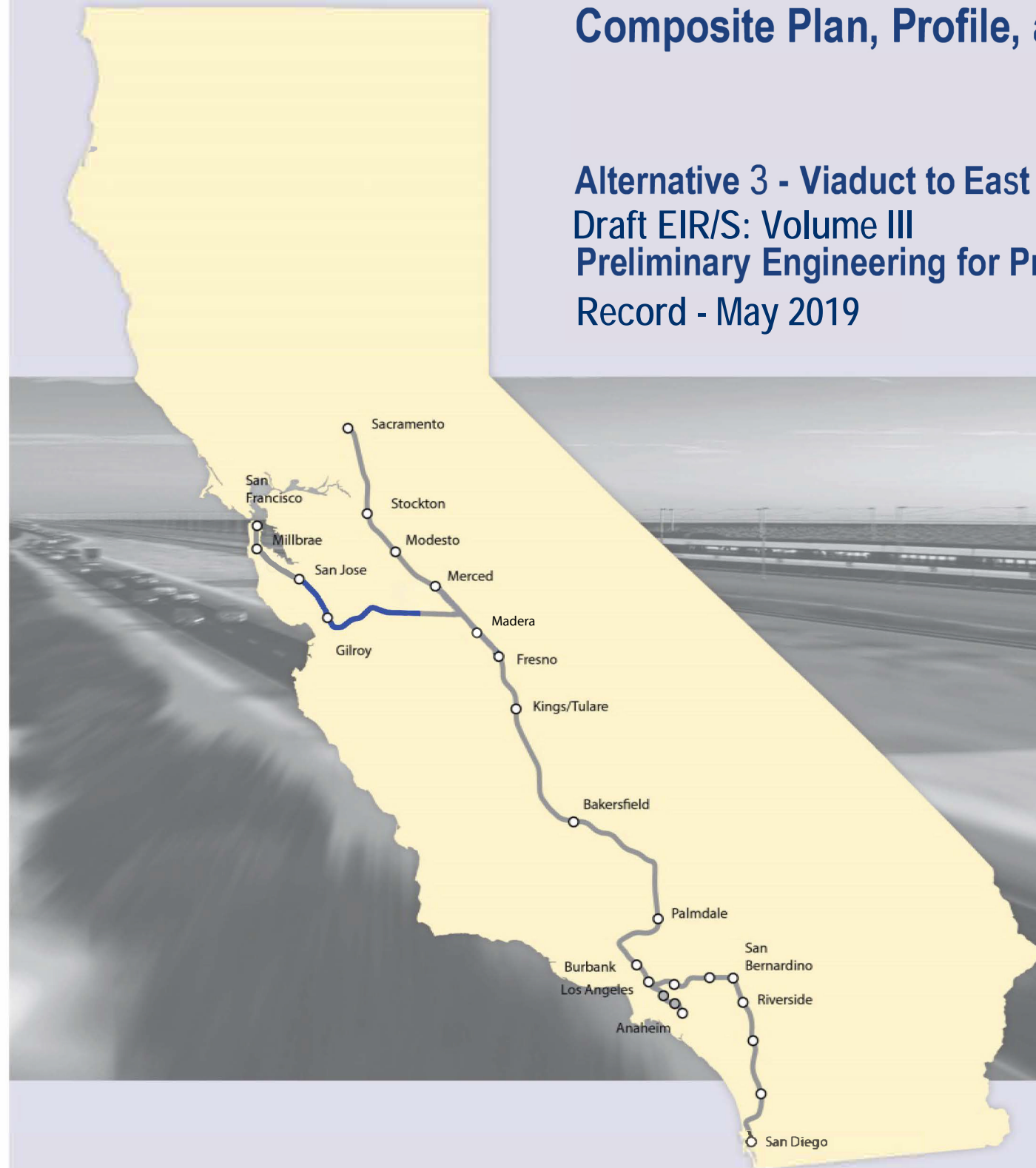

**SAN JOSE TO CVY EIR/S: VOLUME III
ALTERNATIVE 3
BOOK 3A
SHEET 1 - 29 OF 216**

ALTERNATIVE 3 - VIADUCT TO EAST GILROY

BOOK	SHEET NO	DRAWING NO	SUBSECTION	GEOGRAPHIC LOCATION	ALIGNMENT OR FEATURE	SHEET DESCRIPTION	ADDITIONAL DESCRIPTION
COVER, INDEX OF DRAWING AND KEY MAPS							
BOOK 3A	A	COVER	SAN JOSE TO MERCED SECTION	N/A	SAN JOSE TO CENTRAL VALLEY WYE	ALTERNATIVE 3	VIADUCT TO EAST GILROY
BOOK 3A	B	GE-A0301	SAN JOSE DIRIDON STATION APPROACH, MONTEREY CORRIDOR, MORGAN HILL AND GILROY	SCOTT BLVD TO PACHECO PASS HWY	INDEX OF DRAWING	SHEET 1 OF 7	
BOOK 3A	C	GE-D0301	GENERAL	ENTIRE ALTERNATIVE	KEY MAP	COMPOSITE PLAN	
BOOK 3A	D	GE-D0302	GENERAL	ENTIRE ALTERNATIVE	KEY MAP	SYSTEMS SITES	

COMPOSITE PLANS

SAN JOSE DIRIDON STATION APPROACH

BOOK 3A	1	TT-D0251	SAN JOSE DIRIDON STATION APPROACH	SCOTT BLVD TO BENTON ST	VIADUCT TO SCOTT BLVD	COMPOSITE PLAN, PROFILE AND TYPICAL SECTIONS	B2250+00 TO B2340+00
BOOK 3A	2	TT-D0252	SAN JOSE DIRIDON STATION APPROACH	NEWHALL ST TO W TAYLOR ST	VIADUCT TO SCOTT BLVD	COMPOSITE PLAN, PROFILE AND TYPICAL SECTIONS	B2340+00 TO B2430+00
BOOK 3A	3	TT-D0253	SAN JOSE DIRIDON STATION APPROACH	CINNABAR ST TO PARK AVE	VIADUCT TO SCOTT BLVD	COMPOSITE PLAN, PROFILE AND TYPICAL SECTIONS	B2430+00 TO B58+00
BOOK 3A	4	TT-D0301	SAN JOSE DIRIDON STATION APPROACH	PARK AVE TO WILLOW ST	VIADUCT TO I-880	COMPOSITE PLAN, PROFILE AND CROSS SECTIONS	B58+00 TO B125+00

MONTEREY CORRIDOR

BOOK 3A	5	TT-D0401	MONTEREY CORRIDOR	WILLOW ST TO CURTNER AVE	VIADUCT/AT-GRADE	COMPOSITE PLAN, PROFILE AND CROSS SECTIONS	B125+00 TO B211+00
BOOK 3A	6	TT-D0601	MONTEREY CORRIDOR	COMMUNICATION HILL BLVD TO ESFAHAN CT	VIADUCT	COMPOSITE PLAN, PROFILE AND CROSS SECTIONS	B211+00 TO B285+00
BOOK 3A	7	TT-D0602	MONTEREY CORRIDOR	CAPITOL EXPY TO SKYWAY DR	VIADUCT	COMPOSITE PLAN, PROFILE AND CROSS SECTIONS	B285+00 TO B373+00
BOOK 3A	8	TT-D0603	MONTEREY CORRIDOR	BRANHAM LN TO BLOSSOM HILL RD	VIADUCT	COMPOSITE PLAN, PROFILE AND CROSS SECTIONS	B373+00 TO B462+00
BOOK 3A	9	TT-D0604	MONTEREY CORRIDOR	FORD RD	VIADUCT	COMPOSITE PLAN, PROFILE AND CROSS SECTIONS	B462+00 TO B552+00

MORGAN HILL AND GILROY

BOOK 3A	10	TT-D0701	MORGAN HILL AND GILROY	W VALLEY FREEWAY TO MENARD DR	VIADUCT TO DOWNTOWN GILROY	COMPOSITE PLAN, PROFILE AND CROSS SECTIONS	B552+00 TO B730+00
BOOK 3A	11	TT-D0702	MORGAN HILL AND GILROY	METCALF RD TO BLANCHARD RD	VIADUCT TO DOWNTOWN GILROY	COMPOSITE PLAN, PROFILE AND CROSS SECTIONS	B642+00 TO B732+00
BOOK 3A	12	TT-D0703	MORGAN HILL AND GILROY	BAILEY AVE TO RICHMOND AVE	VIADUCT TO DOWNTOWN GILROY	COMPOSITE PLAN, PROFILE AND CROSS SECTIONS	B732+00 TO B8220+00
BOOK 3A	13	TT-D0704	MORGAN HILL AND GILROY	OGIER AVE	VIADUCT TO DOWNTOWN GILROY	COMPOSITE PLAN, PROFILE AND CROSS SECTIONS	B822+00 TO B905+00
BOOK 3A	14	TT-D0705	MORGAN HILL AND GILROY	KIRBY AVE	VIADUCT TO DOWNTOWN GILROY	COMPOSITE PLAN, PROFILE AND CROSS SECTIONS	B905+00 TO B995+00
BOOK 3A	15	TT-D0706	MORGAN HILL AND GILROY	BURNETT AVE TO COCHRANE RD	VIADUCT TO DOWNTOWN GILROY	COMPOSITE PLAN, PROFILE AND CROSS SECTIONS	B995+00 TO B1085+00
BOOK 3A	16	TT-D0707	MORGAN HILL AND GILROY	E MAIN AVE TO BARRETT AVE	VIADUCT TO DOWNTOWN GILROY	COMPOSITE PLAN, PROFILE AND CROSS SECTIONS	B1085+00 TO B1175+00
BOOK 3A	17	TT-D0708	MORGAN HILL AND GILROY	TENNANT AVE TO E MIDDLE AVE	VIADUCT TO DOWNTOWN GILROY	COMPOSITE PLAN, PROFILE AND CROSS SECTIONS	B1175+00 TO B1265+00
BOOK 3A	18	TT-D1101	MORGAN HILL AND GILROY	E SAN MARTIN	VIADUCT TO EAST GILROY	COMPOSITE PLAN, PROFILE AND CROSS SECTIONS	B1265+00 TO B1425+00
BOOK 3A	19	TT-D1102	MORGAN HILL AND GILROY	CHURCH AVE	VIADUCT TO EAST GILROY	COMPOSITE PLAN, PROFILE AND CROSS SECTIONS	B1425+00 TO B1505+00
BOOK 3A	20	TT-D1103	MORGAN HILL AND GILROY	MASTEN AVE TO BUENA VISTA AVE	VIADUCT TO EAST GILROY	COMPOSITE PLAN, PROFILE AND CROSS SECTIONS	B1505+00 TO B1594+00
BOOK 3A	21	TT-D1104	MORGAN HILL AND GILROY	COHANSEY AVE TO LEAVESLEY RD	VIADUCT TO EAST GILROY	COMPOSITE PLAN, PROFILE AND CROSS SECTIONS	B1594+00 TO B1683+00
BOOK 3A	22	TT-D1105	MORGAN HILL AND GILROY	GILMAN RD TO HOLSCRAW RD	VIADUCT TO EAST GILROY	COMPOSITE PLAN, PROFILE AND CROSS SECTIONS	B1683+00 TO B1770+00
BOOK 3A	23	TT-D1106	MORGAN HILL AND GILROY	SR 152 TO JONES CREEK	VIADUCT TO EAST GILROY	COMPOSITE PLAN, PROFILE AND CROSS SECTIONS	B1770+00 TO B1859+00
BOOK 3A	24	TT-D1107	MORGAN HILL AND GILROY	N/A	VIADUCT TO EAST GILROY	UPRR FREIGHT TRACK PROFILE	
BOOK 3A	25	TT-D1301	MORGAN HILL AND GILROY	BLOOMFIELD AVE	VIADUCT TO EAST GILROY	COMPOSITE PLAN, PROFILE AND CROSS SECTIONS	B1859+00 TO B1957+00
BOOK 3A	26	TT-D1302	MORGAN HILL AND GILROY	MILLERS CANAL TO LAKE RD	VIADUCT TO EAST GILROY	COMPOSITE PLAN, PROFILE AND CROSS SECTIONS	B1957+00 TO B2044+00
BOOK 3A	27	TT-D1303	MORGAN HILL AND GILROY	LOVERS LN	VIADUCT TO EAST GILROY	COMPOSITE PLAN, PROFILE AND CROSS SECTIONS	B2044+00 TO B2130+00
BOOK 3A	28	TT-D1304	MORGAN HILL AND GILROY	SR 152	VIADUCT TO EAST GILROY	COMPOSITE PLAN, PROFILE AND CROSS SECTIONS	B2130+00 TO B2215+00
BOOK 3A	29	TT-D1305	MORGAN HILL AND GILROY	SR 152	VIADUCT TO EAST GILROY	COMPOSITE PLAN, PROFILE AND CROSS SECTIONS	B2215+00 TO B2291+73.48

**SAN JOSE TO CVY EIR/S: VOLUME III
ALTERNATIVE 3
BOOK 3A
SHEET B**

\$USER \$DATE \$TIME \$ \$PLTDRVS \$ \$PENTBL \$ \$FILE \$

REV	DATE	BY	CHK	APP	DESCRIPTION

DESIGNED BY
DRAWN BY
CHECKED BY
IN CHARGE
DATE

**RECORD PEPP
SUBMITTAL**

MAY 3, 2019

**NOT FOR
CONSTRUCTION**

HNTB

1111 Broadway
9th Floor
Oakland, CA 94607



CALIFORNIA
High-Speed Rail Authority

**CALIFORNIA HIGH-SPEED TRAIN PROJECT
SAN JOSE TO MERCED**

ALTERNATIVE 3
INDEX OF DRAWING
SHEET 1 OF 7

CONTRACT NO. HSR15-34
DRAWING NO. GE-A0301
SCALE NONE
SHEET NO.

NOTE:
ALTERNATIVE KEY MAP SHOWN SIDE BY SIDE FOR CLARITY.

LEGEND

KEY MAP LEGEND

	AERIAL ORTHO-PHOTO
	COMPOSITE ROLL PLOTS
	GRADE SEPARATION ROLL PLOTS
	TUNNEL ROLL PLOTS
	STRUCTURES ROLL PLOTS
	SECTION BREAK
	CITY LIMITS
	COUNTY LINE
	EXISTING ROAD

ALTERNATIVE 3 BOOK INDEX

- BOOK 3A: COMPOSITE PLAN, PROFILE AND CROSS SECTIONS
- BOOK 3B: COMPOSITE PLAN, PROFILE AND CROSS SECTIONS, STATIONS
- BOOK 3C: STRUCTURES, ROADWAY
- BOOK 3D: ROADWAY, MAINTENANCE OF WAY, TUNNELS - PACHECO PASS
- BOOK 3E: CONSTRUCTION STAGING
- BOOK 3F: ALIGNMENT DATA TABLES

11/7/2019 8:52:25 AM c:\p02\1\constr\11\11\2019\85225.mxd c:\p02\1\constr\11\11\2019\85225.mxd c:\p02\1\constr\11\11\2019\85225.mxd

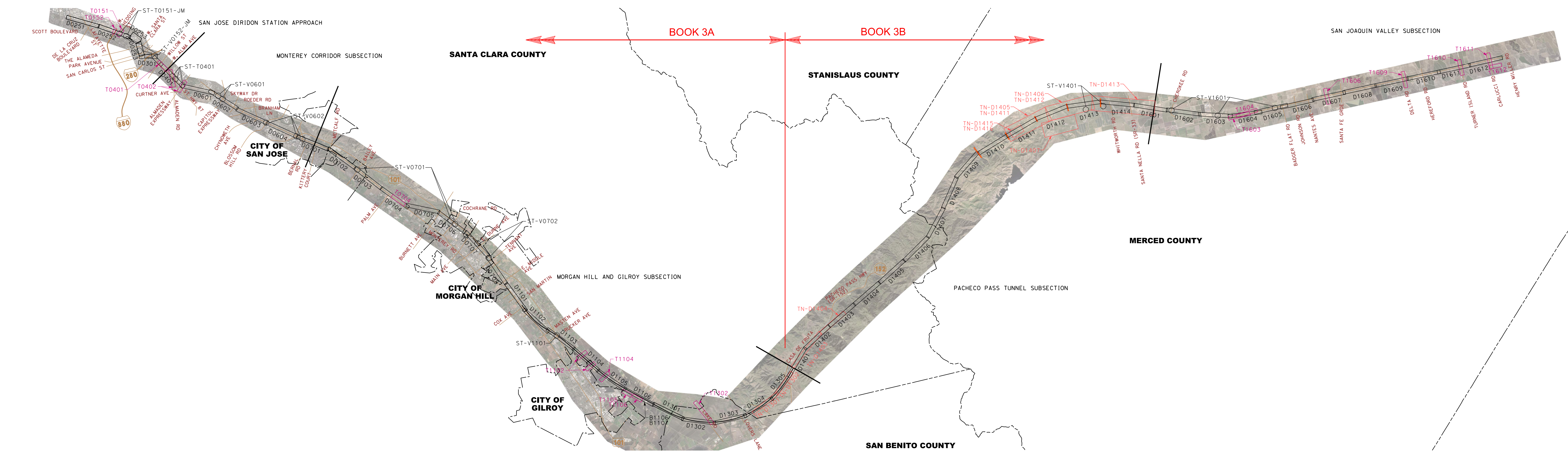

**SAN JOSE TO CVY EIR/S: VOLUME III
ALTERNATIVE 3
BOOK 3A
SHEET C**

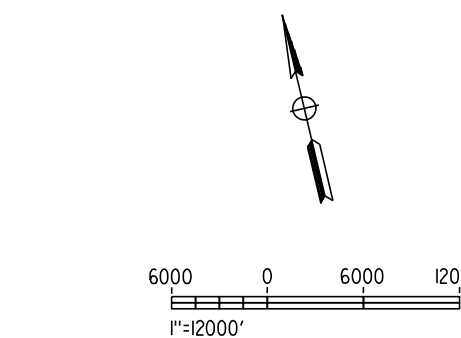

RECORD PERIOD SUBMITTAL MAY 3, 2019 NOT FOR CONSTRUCTION		1111 Broadway 9th Floor Oakland, CA 94607		CALIFORNIA HIGH-SPEED TRAIN PROJECT SAN JOSE TO MERCED ALTERNATIVE 3 KEY MAP COMPOSITE PLAN	CONTRACT NO. HSR15-34 DRAWING NO. CE-D0301 SCALE AS SHOWN SHEET NO.
---	--	---	--	---	--

CITY OF SANTA CLARA

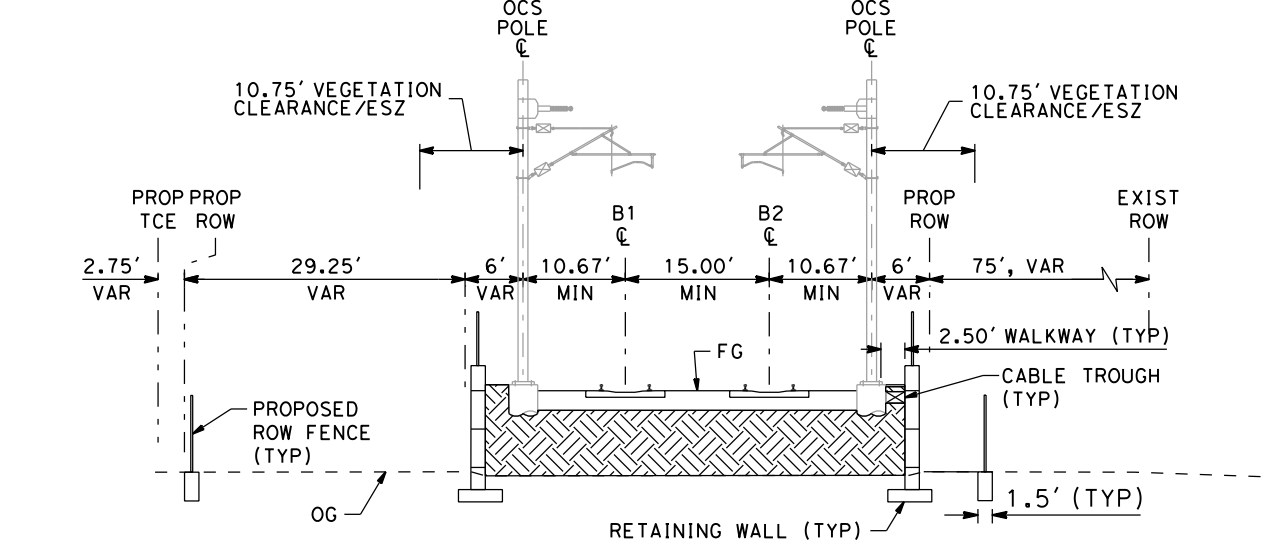
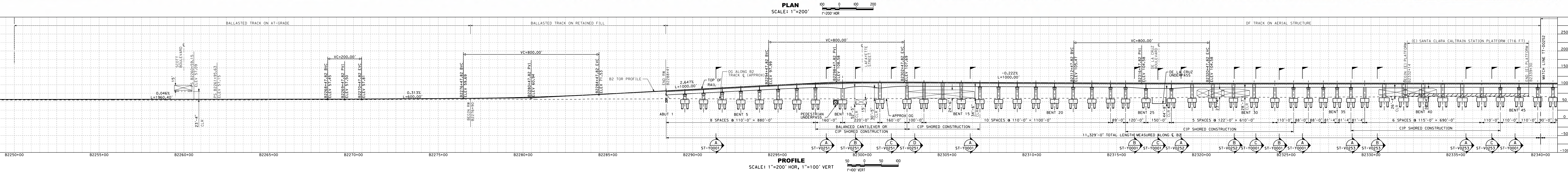
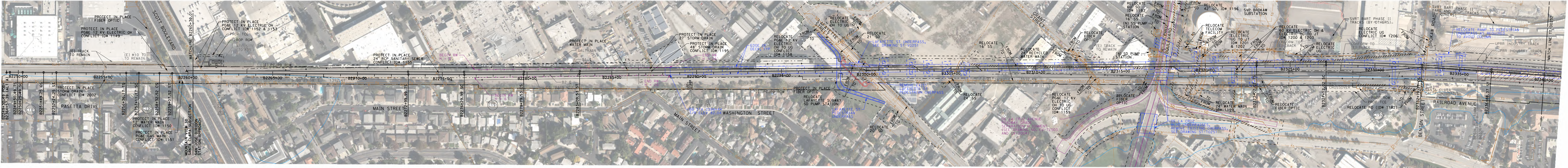

NOTE:
1. REFER TO GENERAL NOTES SHEETS GE-B0001 AND GE-B0002 FOR NOTES.

SAN JOSE TO CVY EIR/S: VOLUME III
ALTERNATIVE 3
BOOK 3A
SHEET 1 OF 216

RECORD PERM SUBMITTAL MAY 3, 2019 NOT FOR CONSTRUCTION	1111 Broadway 9th Floor Oakland, CA 94607	CALIFORNIA High-Speed Rail Authority	CALIFORNIA HIGH-SPEED TRAIN PROJECT SAN JOSE TO MERCED SAN JOSE DIRIDON STATION APPROACH VIADUCT TO SCOTT BLVD COMPOSITE PLAN, PROFILE AND TYPICAL SECTIONS B2250+00 TO B2340+00	CONTRACT NO. HSR15-34 DRAWING NO. TT-D0251 SCALE AS SHOWN SHEET NO.
--	---	--------------------------------------	---	--

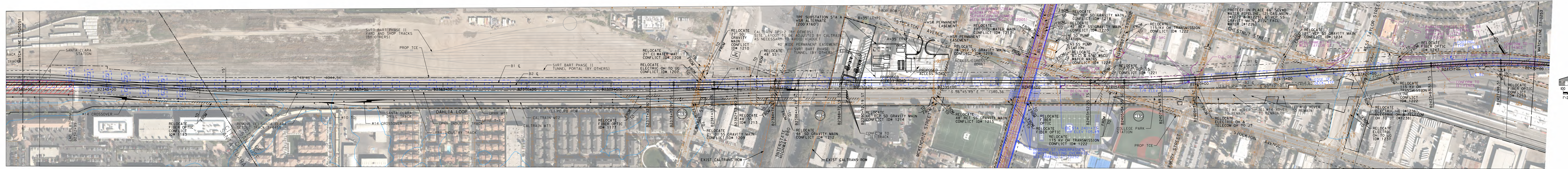

PLAN SCALE: 1"=200'

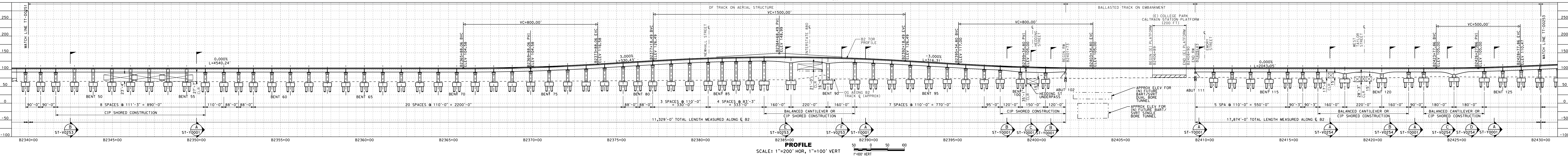

PROFILE SCALE: 1"=200' HOR, 1"=100' VERT

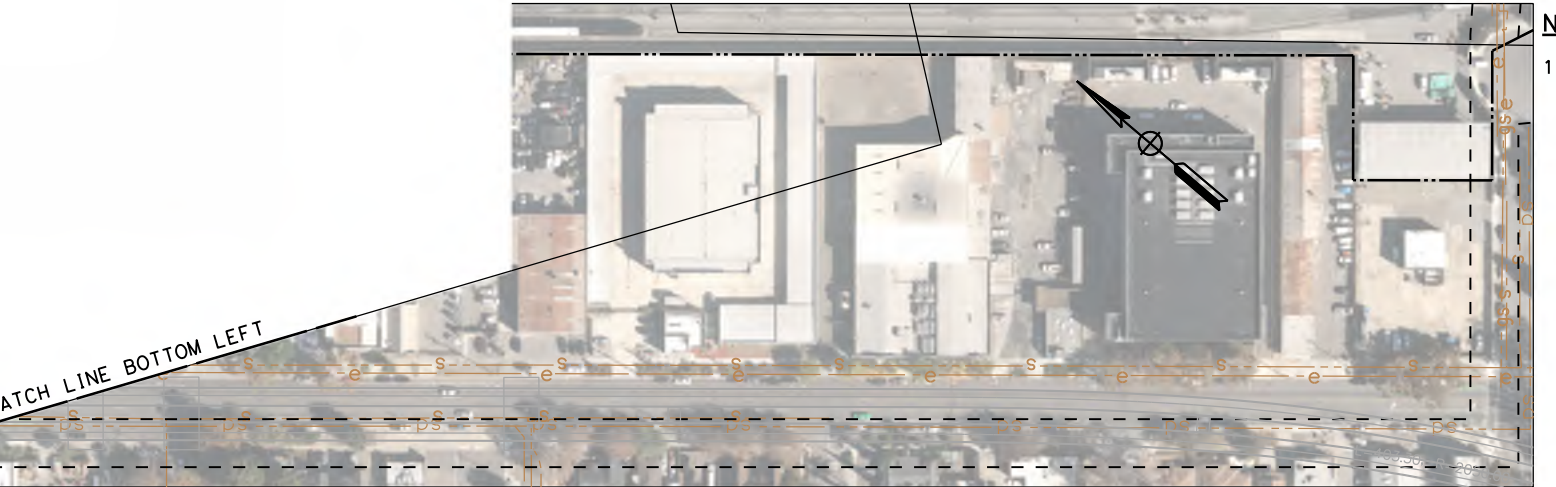

VIADUCT 2 TRACK (DIRIDON AREA) SCALE: 1"=20'

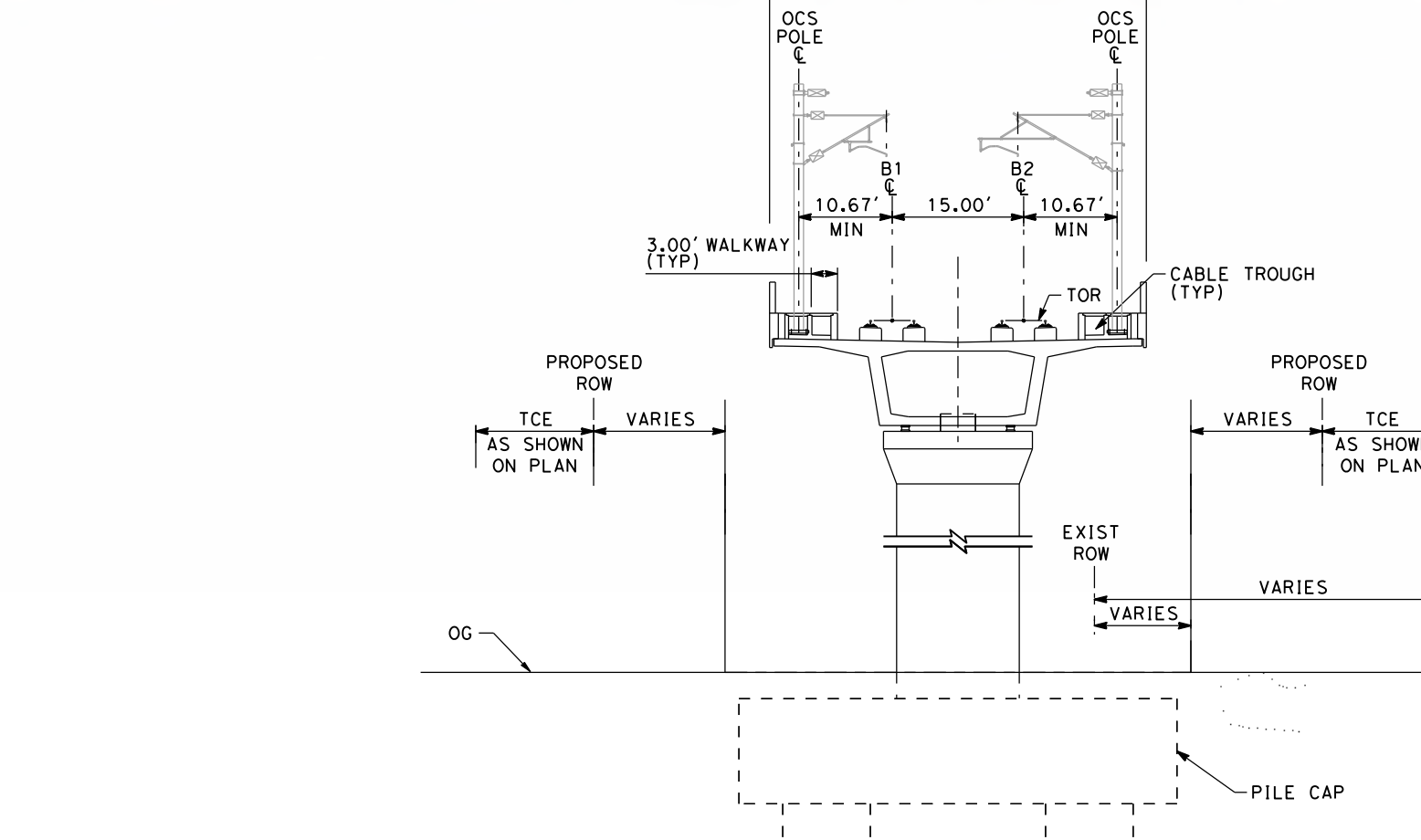

VIADUCT 2 TRACK (DIRIDON AREA) SCALE: 1"=20'

"B" 2288+44 TO "B" 2401+73
"B" 2409+43 TO "B" 2462+88

NOTE:
1. REFER TO GENERAL NOTES SHEETS GE-B0001 AND GE-B0002 FOR NOTES.

SAN JOSE TO CVY EIR/S: VOLUME III
ALTERNATIVE 3
BOOK 3A
SHEET 2 OF 216

RECORD PERM SUBMITTAL MAY 3, 2019 NOT FOR CONSTRUCTION		1111 Broadway 9th Floor Oakland, CA 94607		CALIFORNIA HIGH-SPEED TRAIN PROJECT SAN JOSE TO MERCED SAN JOSE DIRIDON STATION APPROACH VIADUCT TO SCOTT BLVD COMPOSITE PLAN, PROFILE AND TYPICAL SECTIONS B2340+00 TO B2430+00	CONTRACT NO. HSR15-34 DRAWING NO. TT-D0252 SCALE AS SHOWN SHEET NO.
--	--	---	--	---	---

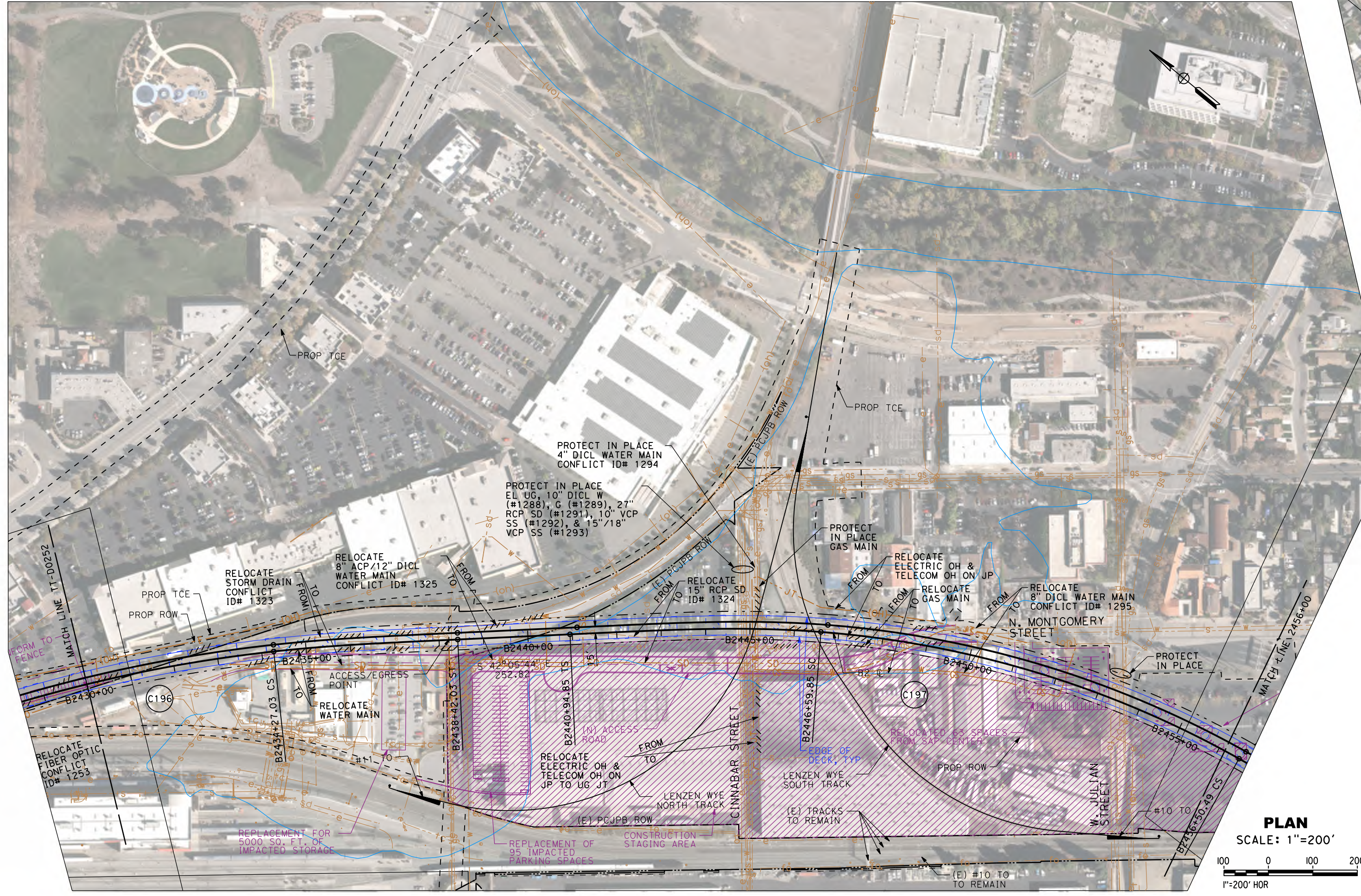

PLAN
SCALE: 1"=200'
1"=200' HOR

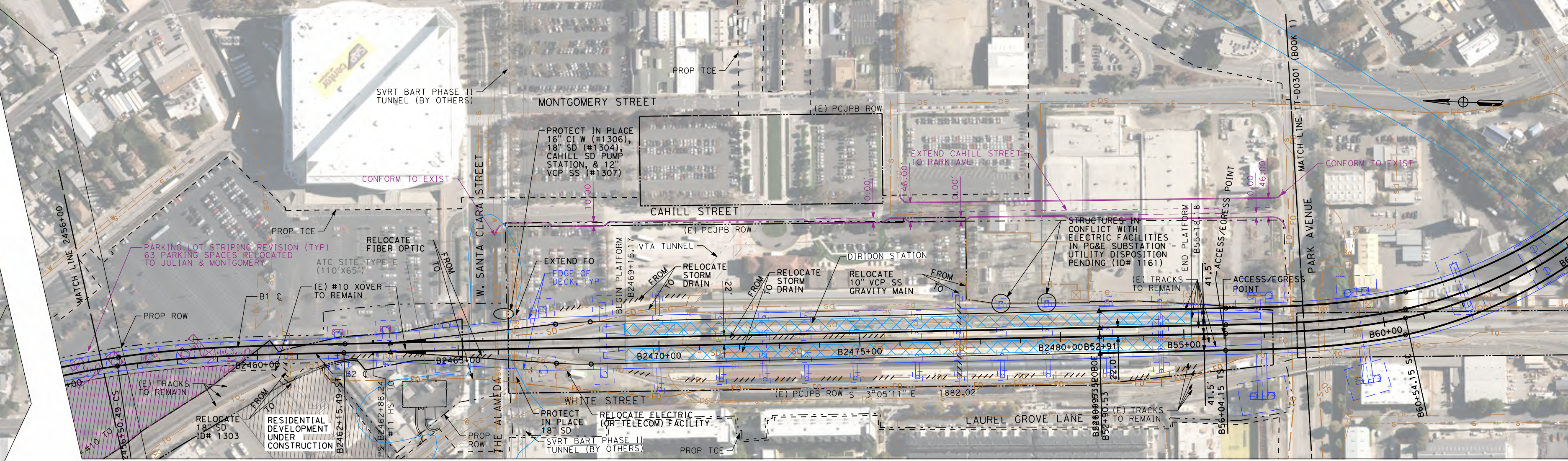

PROFILE
SCALE: 1"=200' HOR, 1"=100' VERT
1"=100' VERT

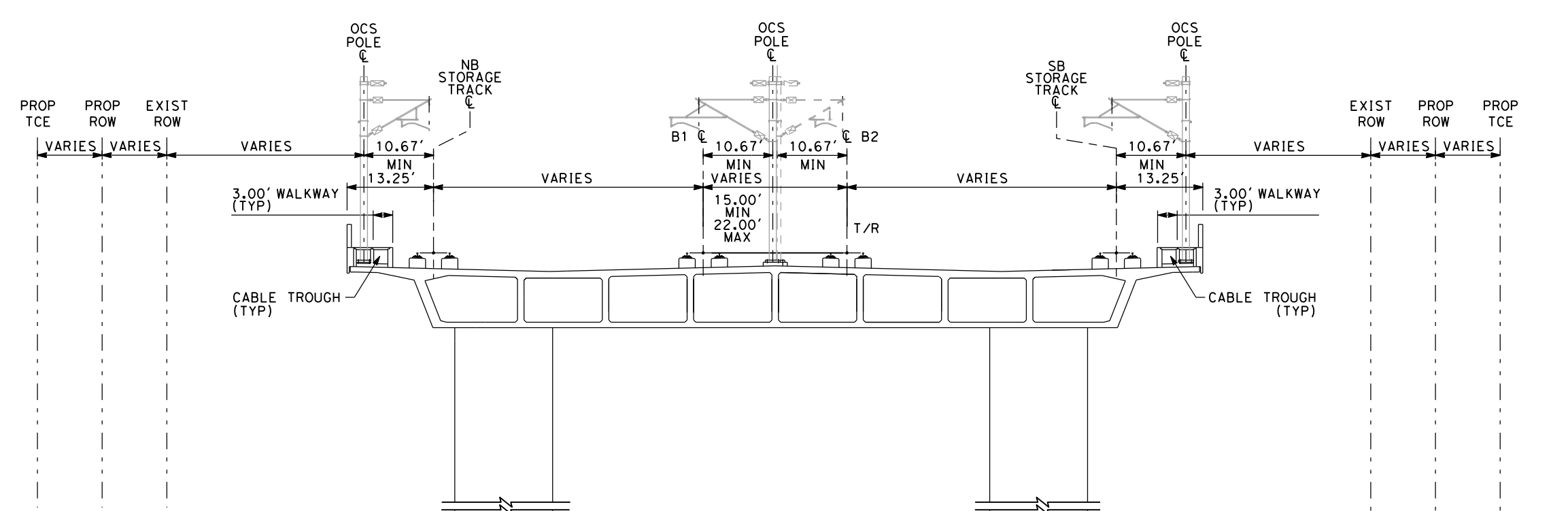
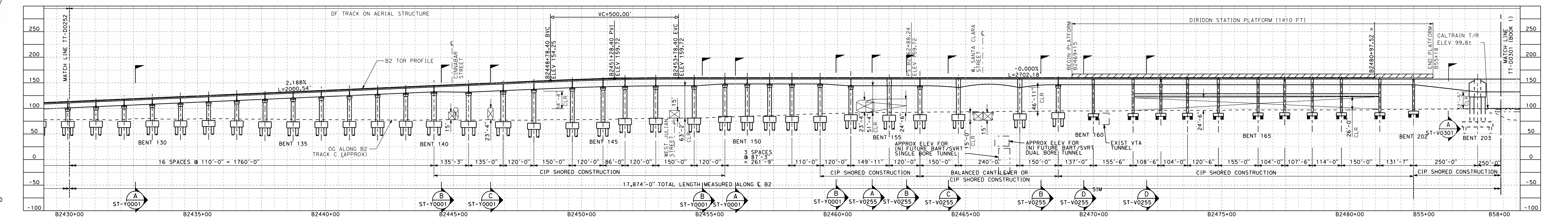

SAN JOSE TO CVY EIR/S: VOLUME III
ALTERNATIVE 3
BOOK 3A
SHEET 3 OF 216

VIADUCT 4 TRACK (NORTH DIRIDON AREA)
 SCALE: 1"=20'
 "B" 1145+00 TO "B": 1275+00
 "B" 2462+88 TO "B" 2480+97

NOTE:
 1. REFER TO GENERAL NOTES SHEETS GE-B0001 AND GE-B0002 FOR NOTES.

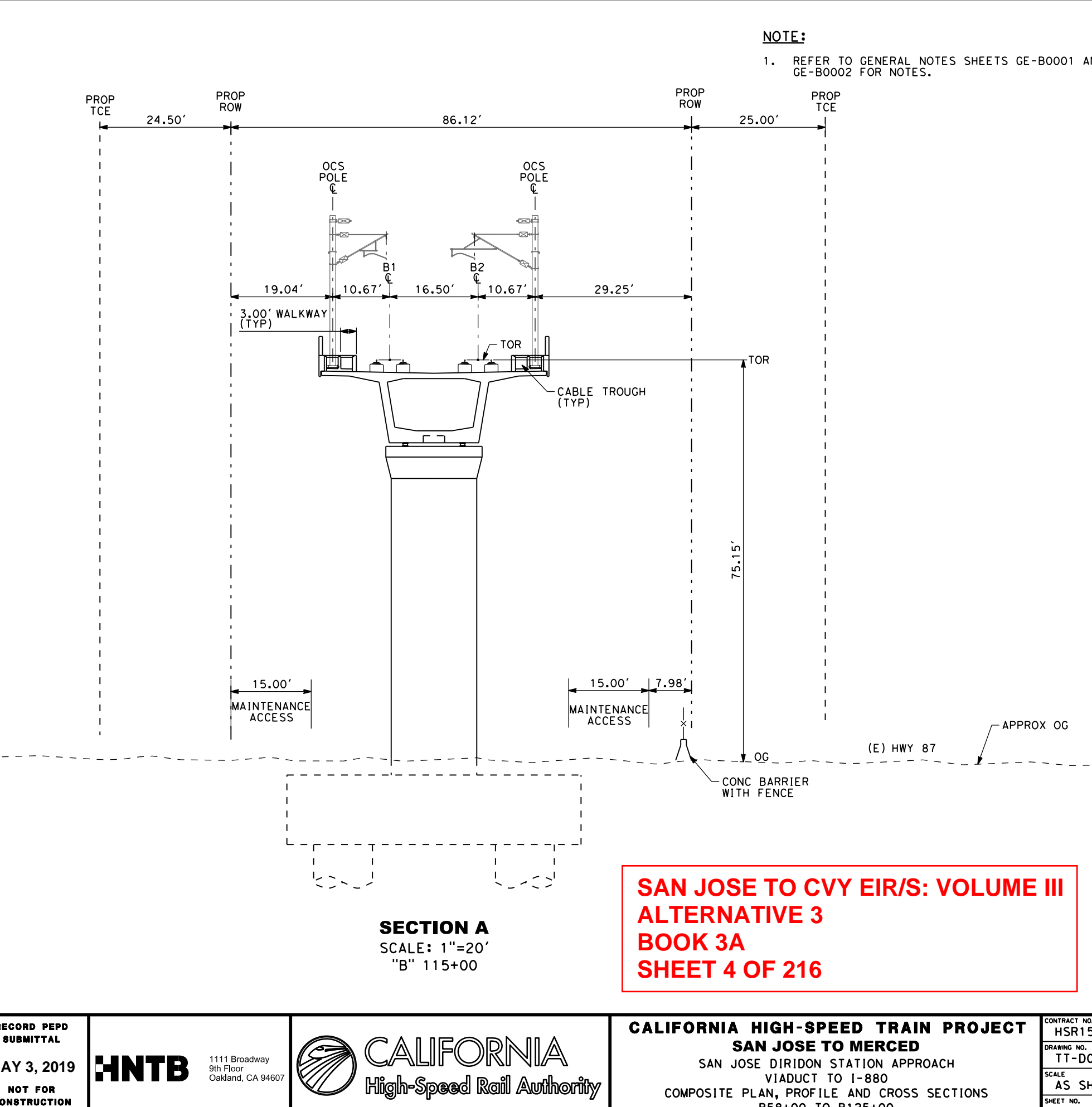
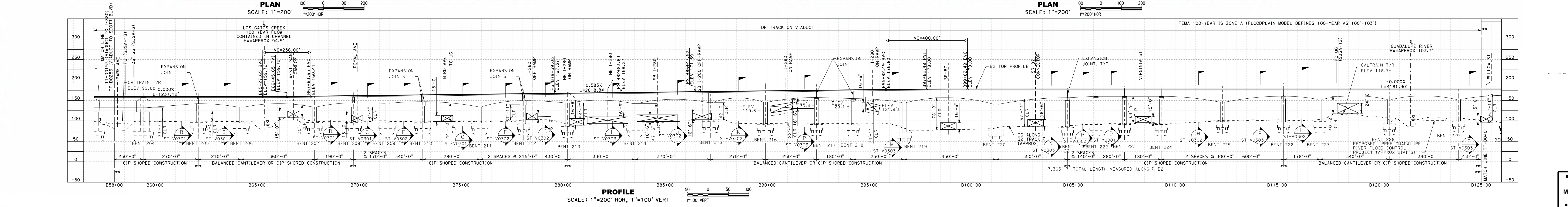
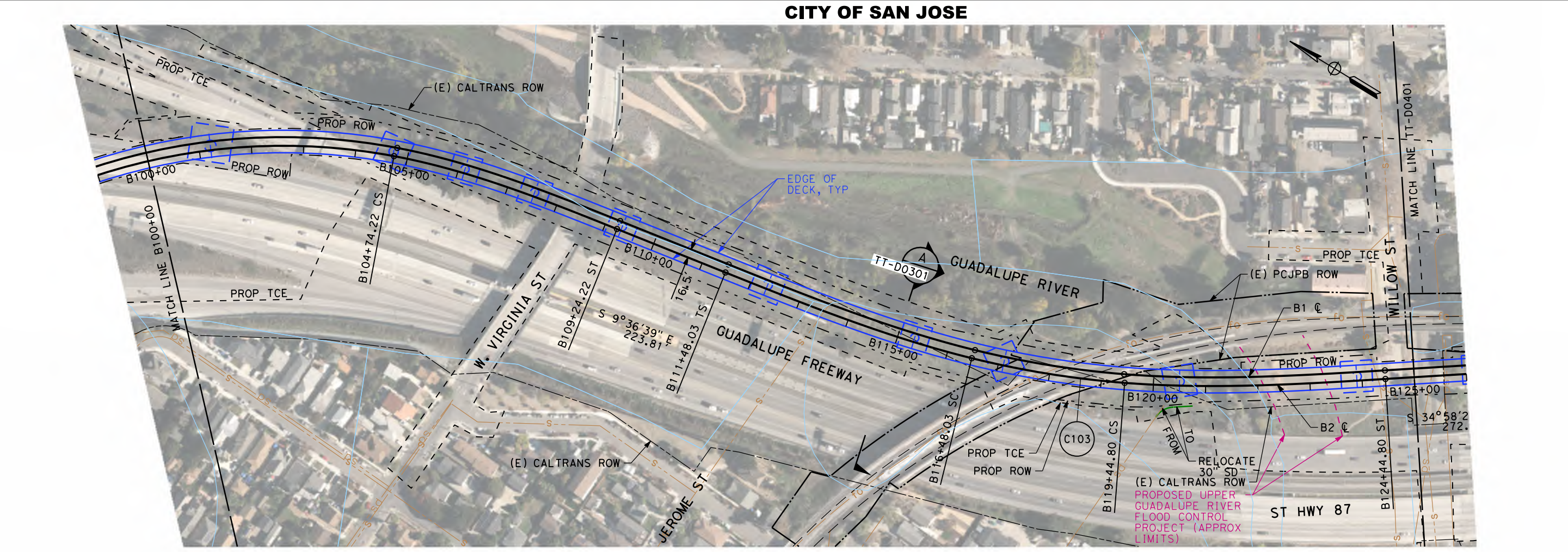
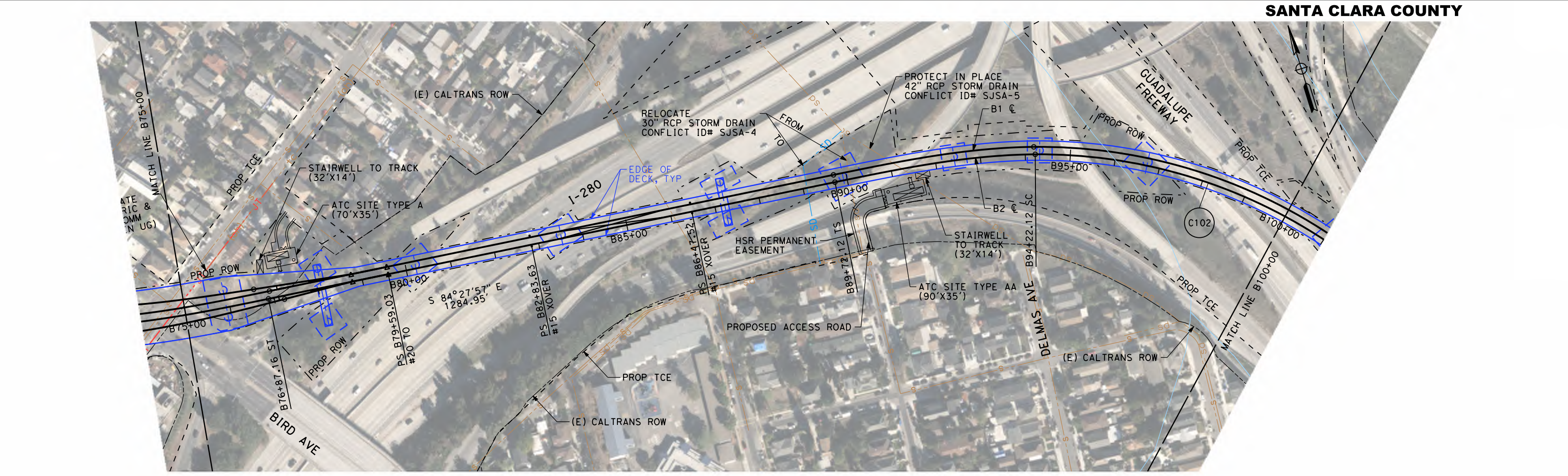
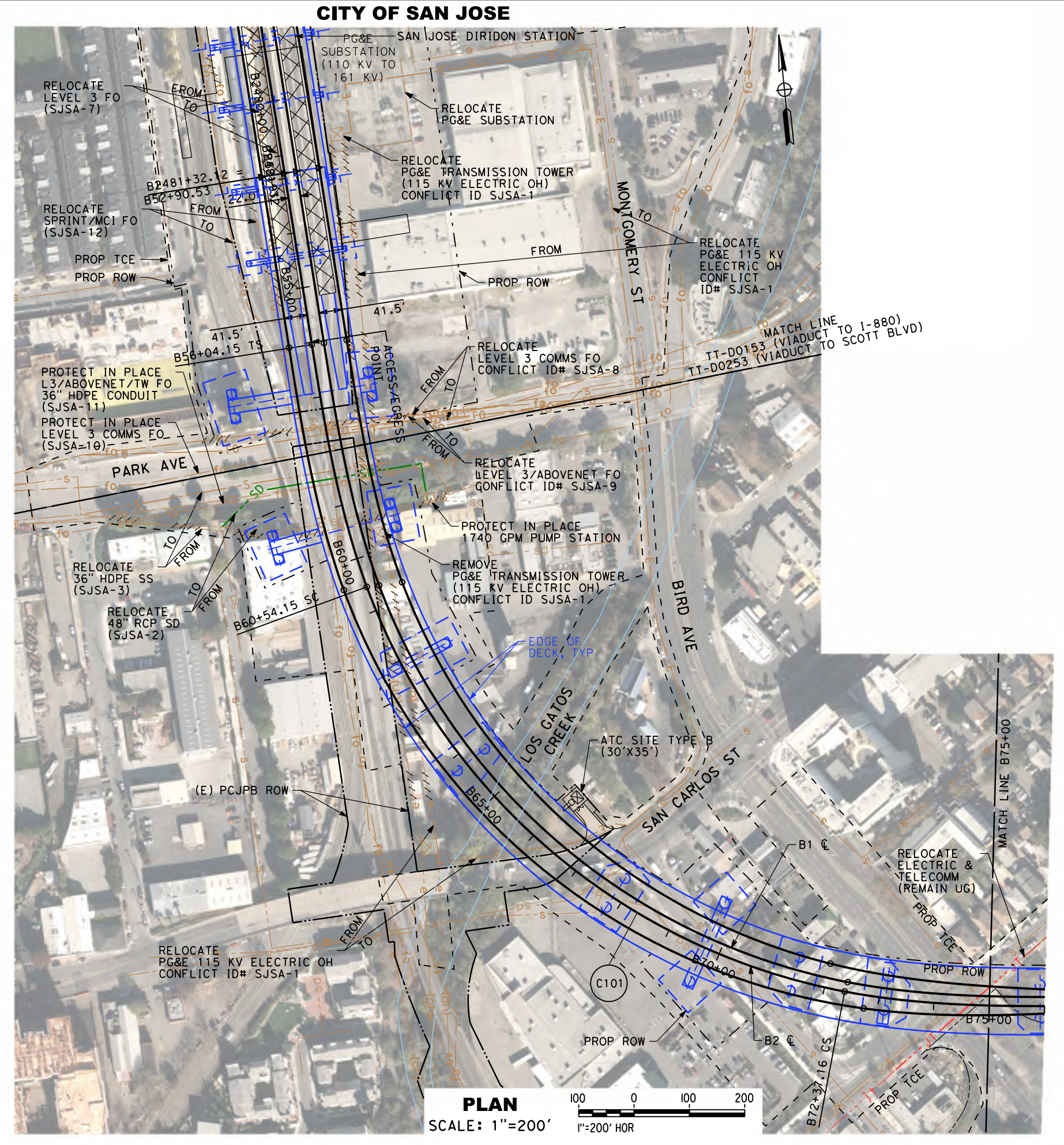

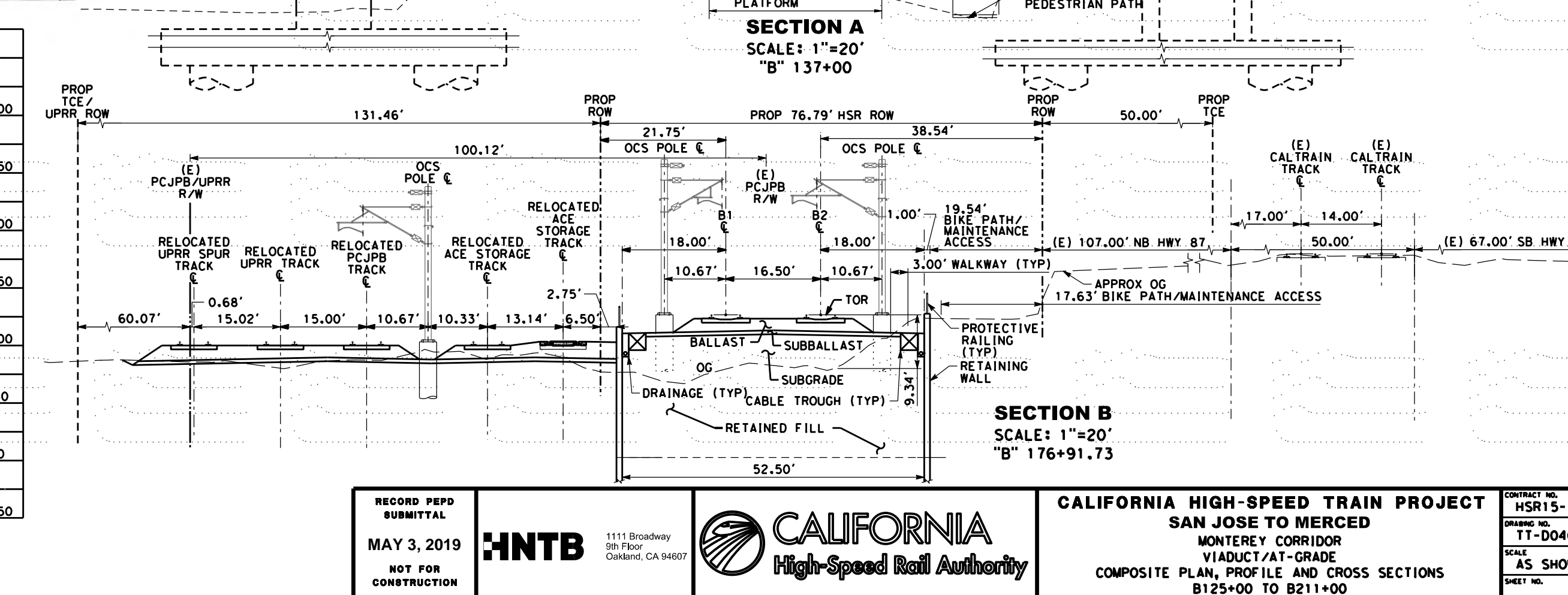
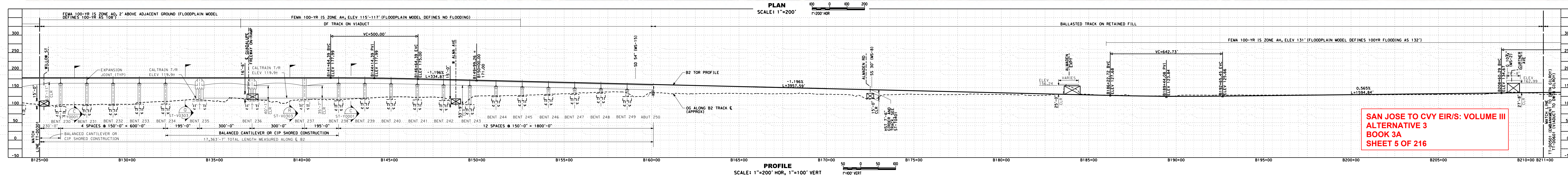


**SAN JOSE TO CVY EIR/S: VOLUME III
ALTERNATIVE 3
BOOK 3A
SHEET 5 OF 216**

RECORD PREP SUBMITTAL MAY 3, 2019 NOT FOR CONSTRUCTION		1111 Broadway 9th Floor Oakland, CA 94607		CALIFORNIA HIGH-SPEED TRAIN PROJECT SAN JOSE TO MERCED MONTEREY CORRIDOR VIADUCT AT-GRADE COMPOSITE PLAN, PROFILE AND CROSS SECTIONS B125+00 TO B211+00	CONTRACT NO. HSR15-34 DRAWING NO. TT-D0401 SCALE AS SHOWN SHEET NO.
--	--	---	--	--	--

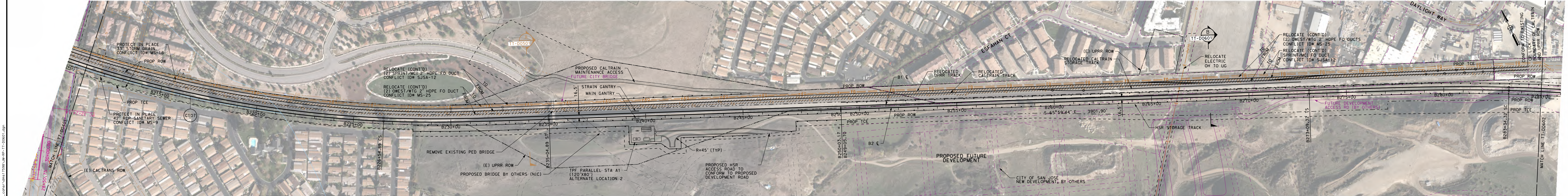

PLAN SCALE: 1"=200'

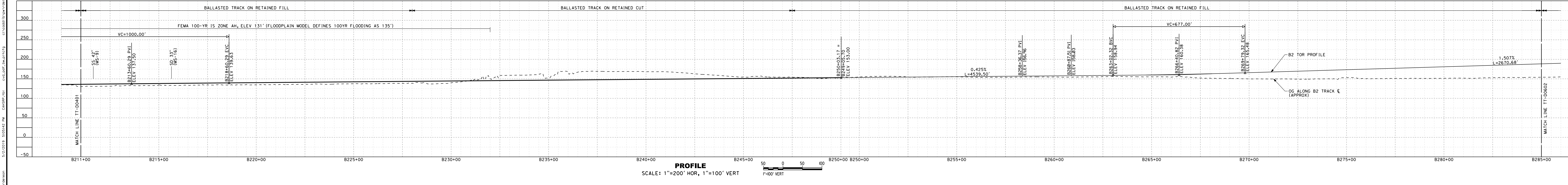

PROFILE SCALE: 1"=200' HOR, 1"=100' VERT

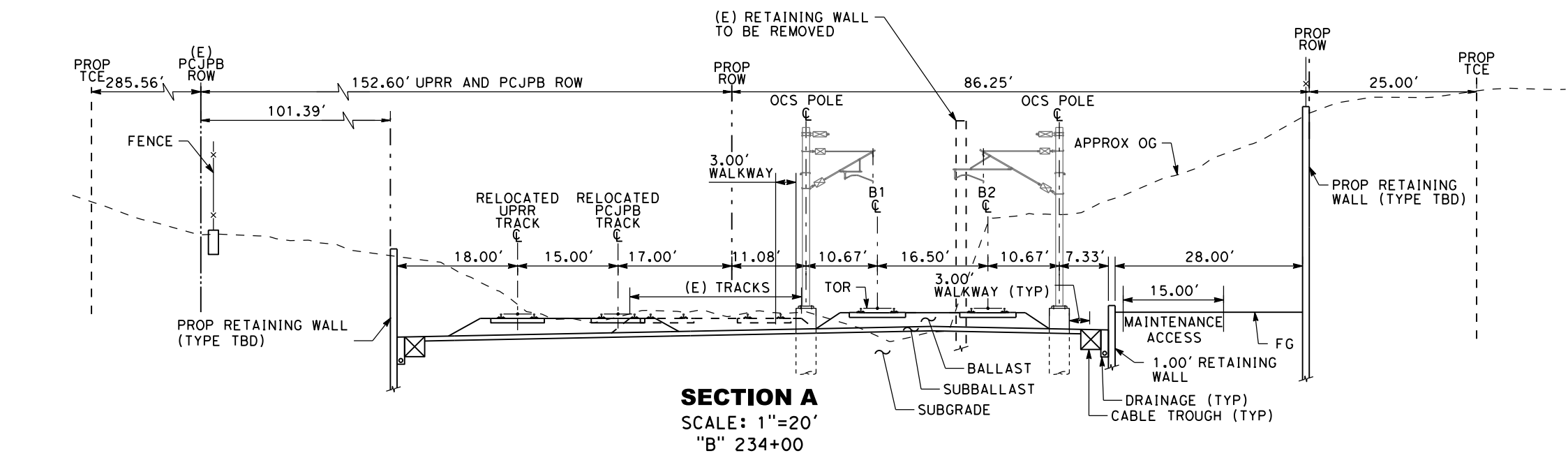

SECTION A SCALE: 1"=20' 'B' 234+00

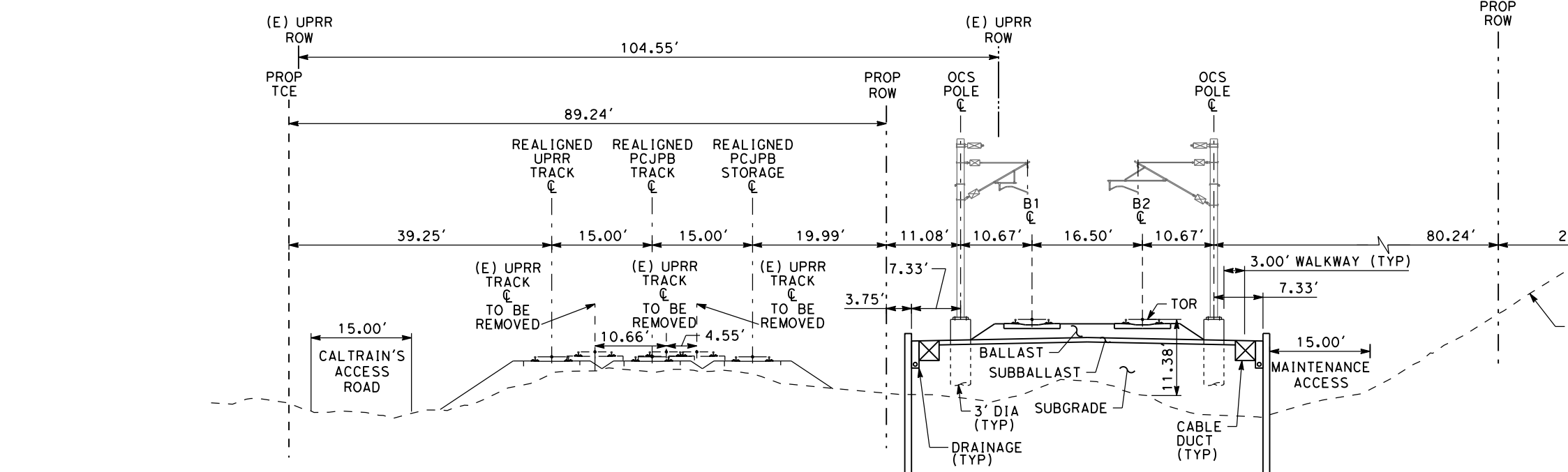

SECTION B SCALE: 1"=20' 'B' 268+00

NOTE: 1. REFER TO GENERAL NOTES SHEETS GE-B0001 AND GE-B0002 FOR NOTES.

SAN JOSE TO CVY EIR/S: VOLUME III ALTERNATIVE 3 BOOK 3A SHEET 6 OF 216

RECORD PERM SUBMITTAL MAY 3, 2019 NOT FOR CONSTRUCTION

HNTB 1111 Broadway 9th Floor Oakland, CA 94607

CALIFORNIA High-Speed Rail Authority

CALIFORNIA HIGH-SPEED TRAIN PROJECT SAN JOSE TO MERCED MONTEREY CORRIDOR VIADUCT COMPOSITE PLAN, PROFILE AND CROSS SECTIONS B211+00 TO B285+00

CONTRACT NO. HSR15-34 DRAWING NO. TT-D0601 SCALE: AS SHOWN SHEET NO.

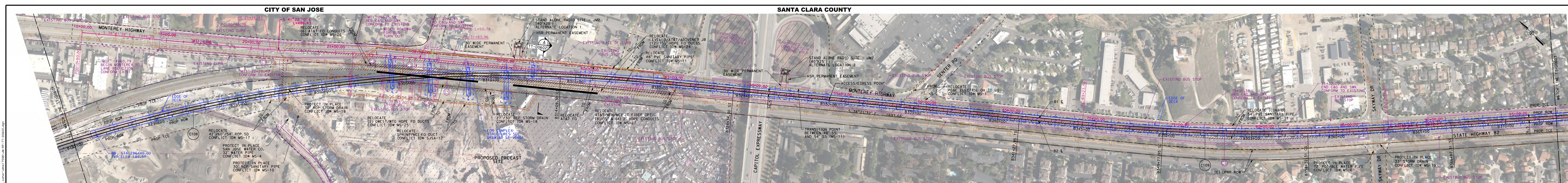

PLAN
SCALE: 1"=200'
1"=200' HOR

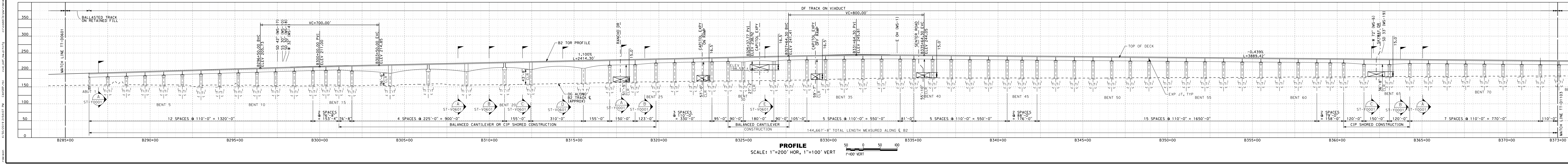

PROFILE
SCALE: 1"=200' HOR, 1"=100' VERT
1"=100' VERT

SAN JOSE TO CVY EIR/S: VOLUME III
ALTERNATIVE 3
BOOK 3A
SHEET 7 OF 216

- NOTES:**
1. REFER TO GENERAL NOTES SHEETS GE-B0001 AND GE-B0002 FOR NOTES.
 2. FOR MONTEREY ROAD ALIGNMENT DATA TABLE SEE DRAWING NO. CV-T0101.

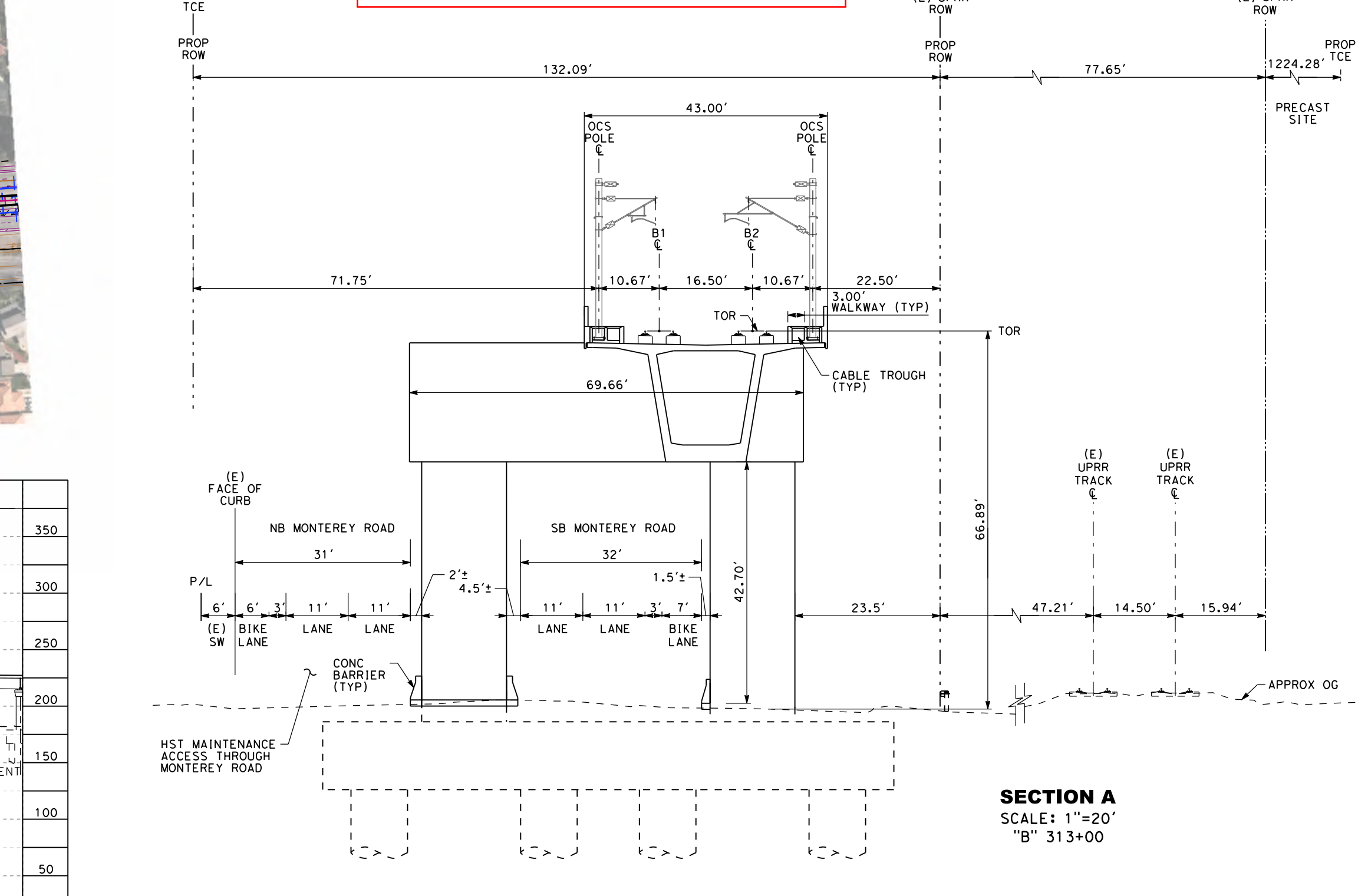

SECTION A
SCALE: 1"=20'
"B" 313+00

<p>RECORD PERM SUBMITTAL MAY 3, 2019 NOT FOR CONSTRUCTION</p>	<p>HNTB 1111 Broadway 9th Floor Oakland, CA 94607</p>	<p>CALIFORNIA High-Speed Rail Authority</p>	<p>CALIFORNIA HIGH-SPEED TRAIN PROJECT SAN JOSE TO MERCED MONTEREY CORRIDOR VIADUCT COMPOSITE PLAN, PROFILE AND CROSS SECTIONS B285+00 TO B373+00</p>	<p>CONTRACT NO. HSR15-34 DRAWING NO. TT-D0602 SCALE: AS SHOWN SHEET NO.</p>
---	--	--	--	---

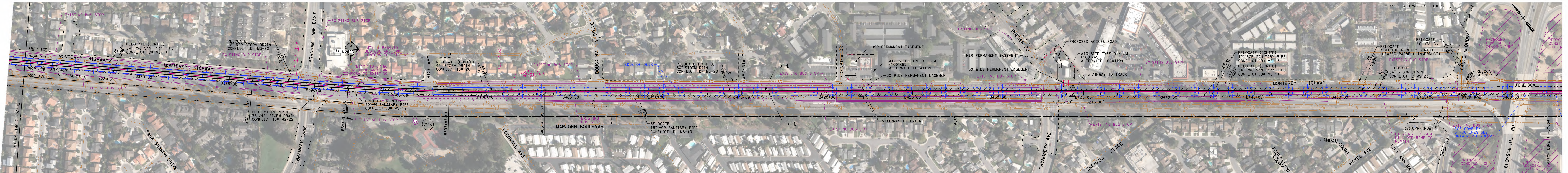

PLAN SCALE: 1"=200'

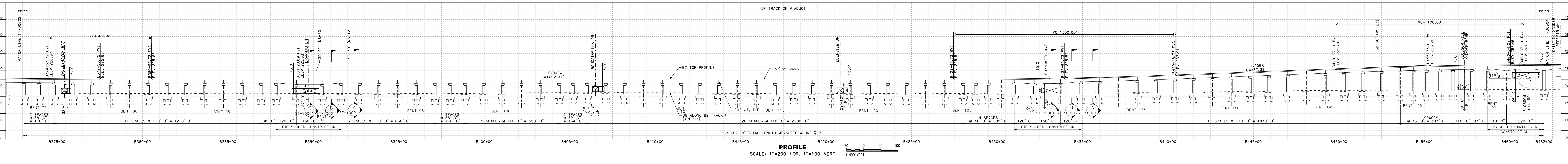

PROFILE SCALE: 1"=200' HOR, 1"=100' VERT

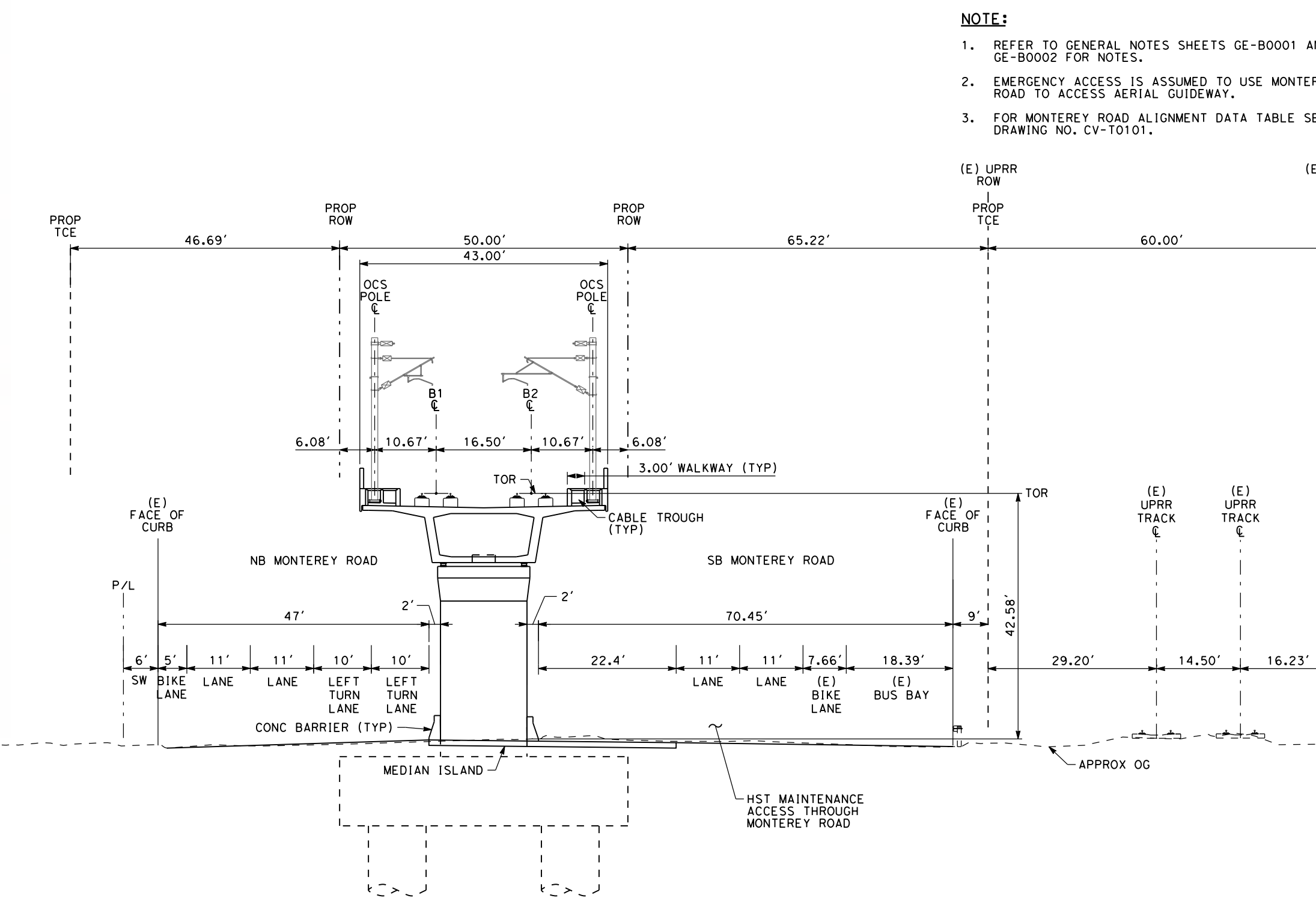

SECTION A SCALE: 1"=20'

- NOTE:**
- REFER TO GENERAL NOTES SHEETS GE-B0001 AND GE-B0002 FOR NOTES.
 - EMERGENCY ACCESS IS ASSUMED TO USE MONTEREY ROAD TO ACCESS AERIAL GUIDEWAY.
 - FOR MONTEREY ROAD ALIGNMENT DATA TABLE SEE DRAWING NO. CV-T0101.

SAN JOSE TO CVY EIR/S: VOLUME III
ALTERNATIVE 3
BOOK 3A
SHEET 8 OF 216

RECORD PERM SUBMITTAL MAY 3, 2019 NOT FOR CONSTRUCTION		1111 Broadway 9th Floor Oakland, CA 94607		CALIFORNIA HIGH-SPEED TRAIN PROJECT SAN JOSE TO MERCED MONTEREY CORRIDOR VIADUCT COMPOSITE PLAN, PROFILE AND CROSS SECTIONS B373+00 TO B462+00	CONTRACT NO. HSR15-34 DRAWING NO. TT-D0603 SCALE AS SHOWN SHEET NO.
--	--	---	--	--	--

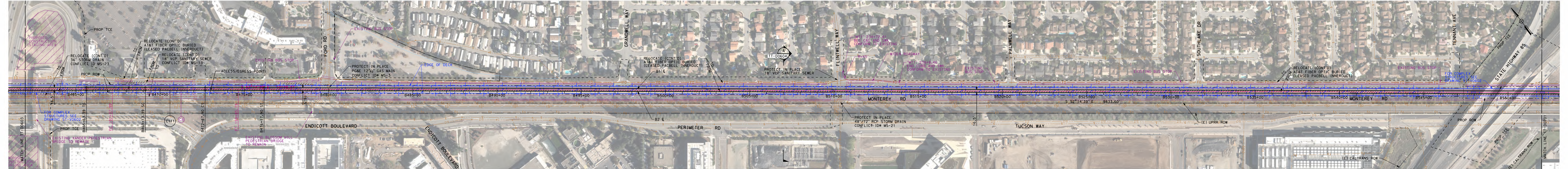

PLAN SCALE: 1"=200'

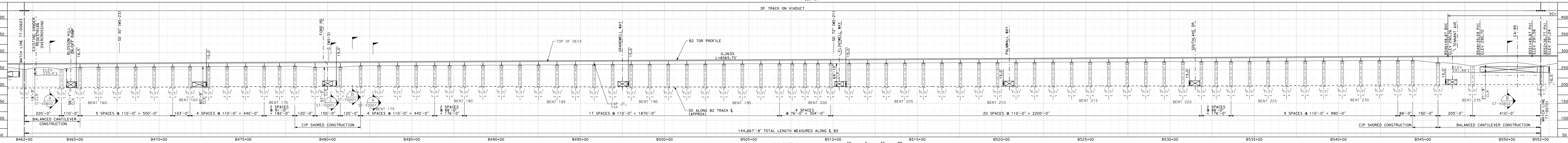

PROFILE SCALE: 1"=200' HOR, 1"=100' VERT

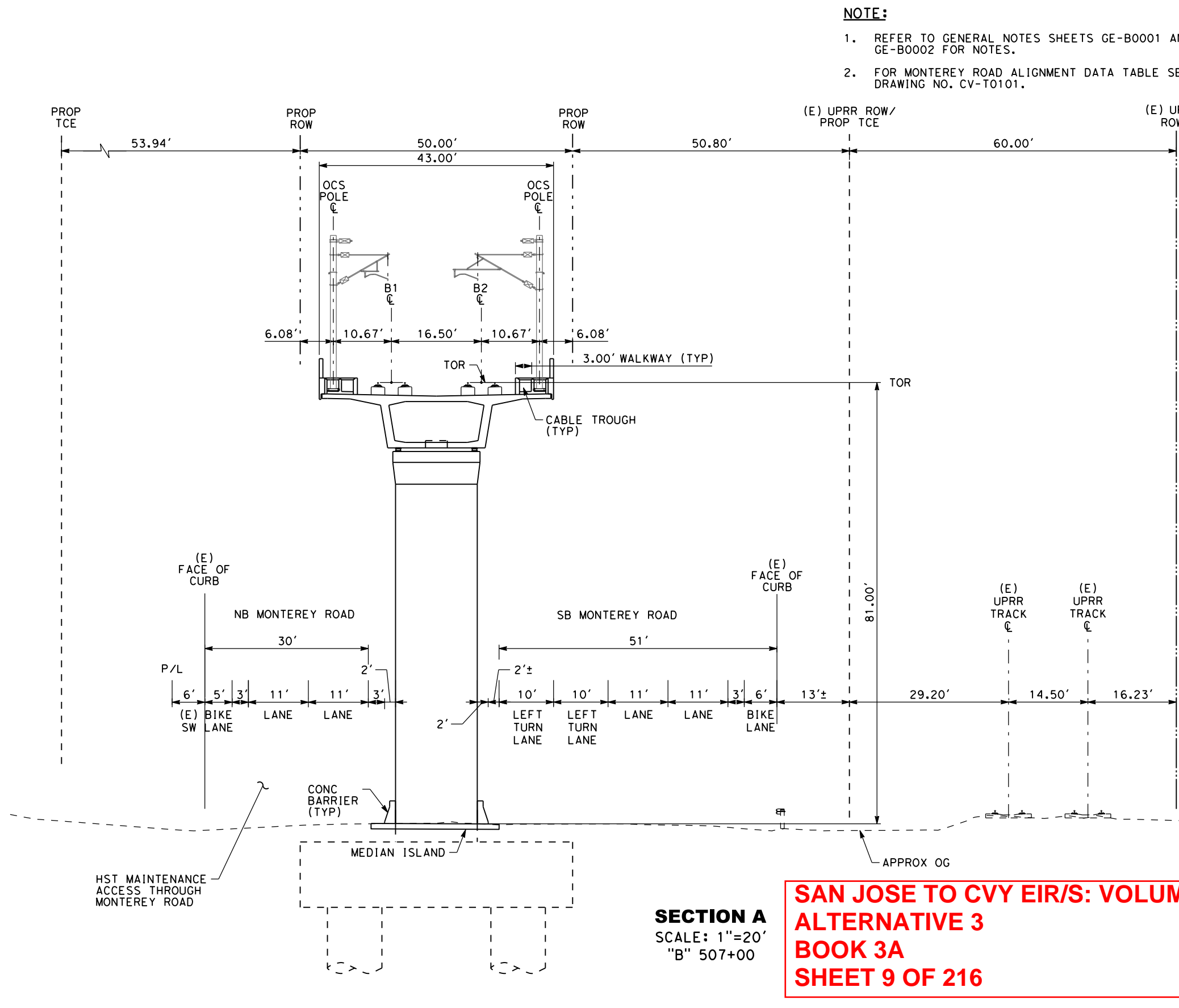

SECTION A SCALE: 1"=20' B" 507+00

- NOTE:
- REFER TO GENERAL NOTES SHEETS GE-B0001 AND GE-B0002 FOR NOTES.
 - FOR MONTEREY ROAD ALIGNMENT DATA TABLE SEE DRAWING NO. CV-T0101.

SAN JOSE TO CVY EIR/S: VOLUME III
ALTERNATIVE 3
BOOK 3A
SHEET 9 OF 216

<p>RECORD PERM SUBMITTAL MAY 3, 2019 NOT FOR CONSTRUCTION</p>	<p>HNTB 1111 Broadway 9th Floor Oakland, CA 94607</p>	<p>CALIFORNIA High-Speed Rail Authority</p>	<p>CALIFORNIA HIGH-SPEED TRAIN PROJECT SAN JOSE TO MERCED MONTEREY CORRIDOR VIADUCT COMPOSITE PLAN, PROFILE AND CROSS SECTIONS B462+00 TO B552+00</p>	<p>CONTRACT NO. HSR15-34 DRAWING NO. TT-D0604 SCALE AS SHOWN SHEET NO.</p>
---	---	---	---	--

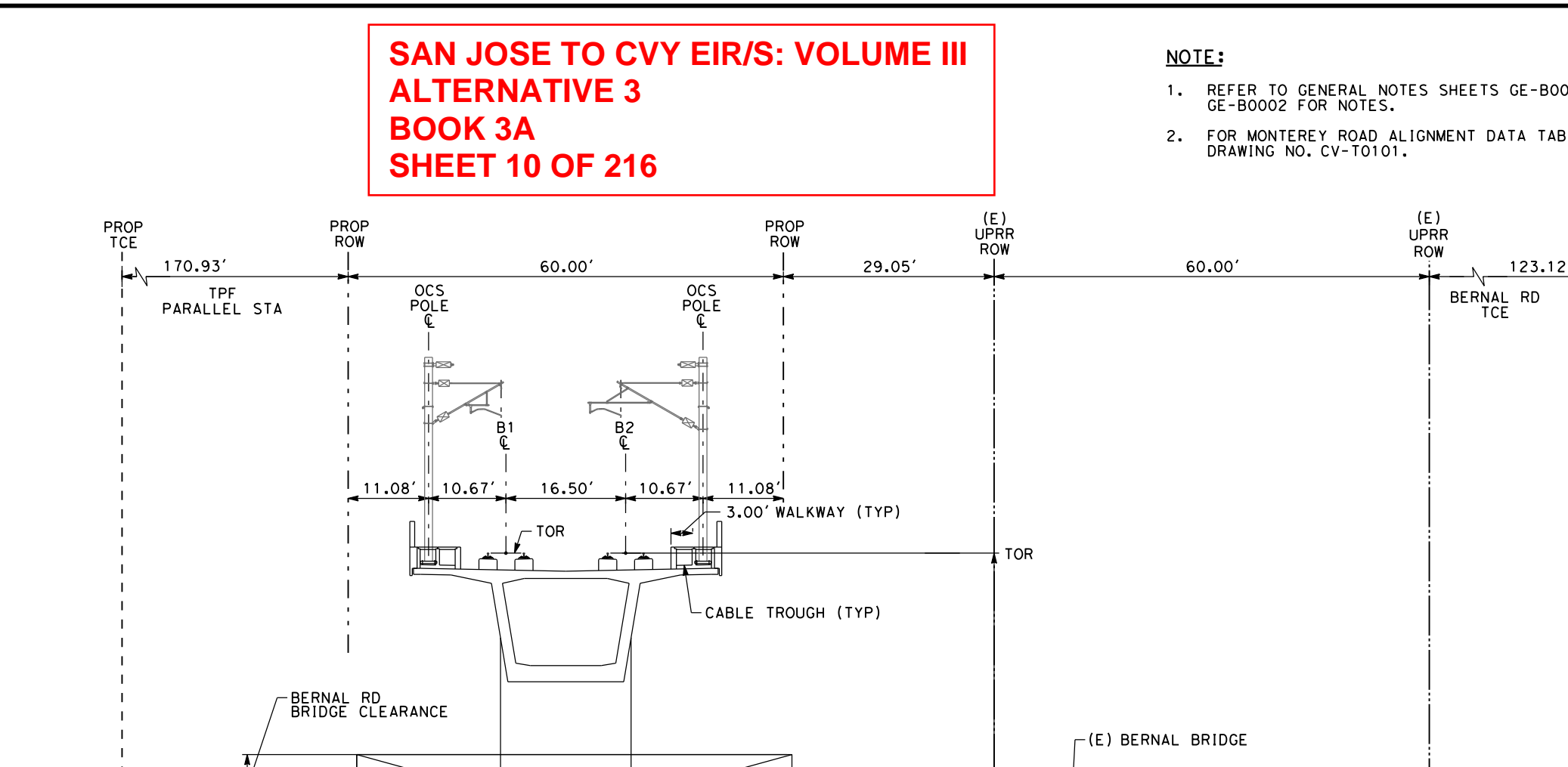
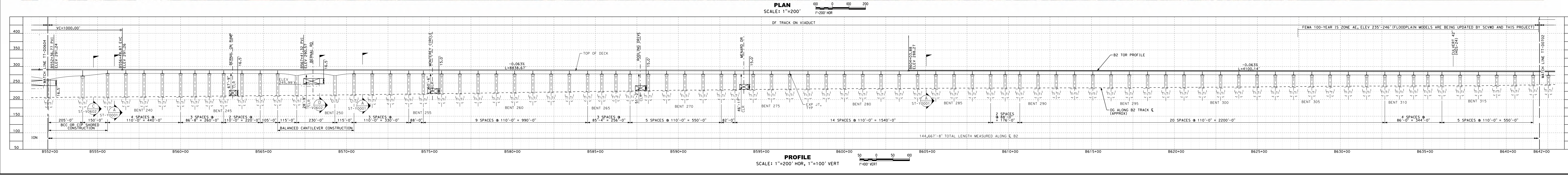
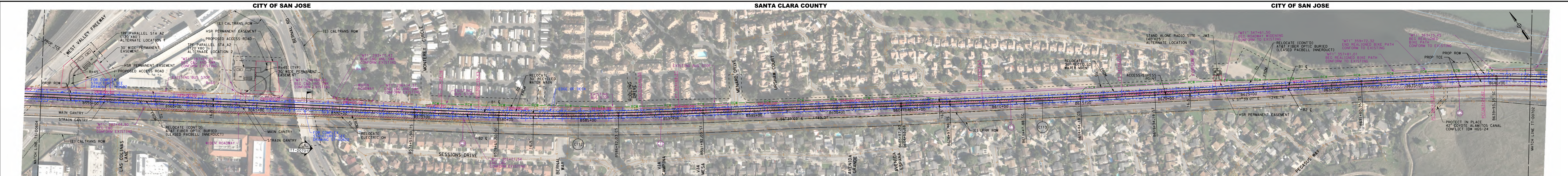

SAN JOSE TO CVY EIR/S: VOLUME III
ALTERNATIVE 3
BOOK 3A
SHEET 10 OF 216

NOTE:

- REFER TO GENERAL NOTES SHEETS GE-B0001 AND GE-B0002 FOR NOTES.
- FOR MONTEREY RD ALIGNMENT DATA TABLE SEE DRAWING NO. CV-T0101.

SECTION A
SCALE: 1"=20'
"B" 568+00

RECORD PERM SUBMITTAL	HNTB	1111 Broadway 9th Floor Oakland, CA 94607	CALIFORNIA High-Speed Rail Authority	CALIFORNIA HIGH-SPEED TRAIN PROJECT SAN JOSE TO MERCED MORGAN HILL AND GILROY VIADUCT TO DOWNTOWN GILROY COMPOSITE PLAN, PROFILE AND CROSS SECTIONS B552+00 TO B730+00
MAY 3, 2019	NOT FOR CONSTRUCTION			CONTRACT NO. HSR15-34 DRAWING NO. TT-D0701 SCALE AS SHOWN SHEET NO.



PLAN
SCALE: 1"=200'



PROFILE
SCALE: 1"=200' HOR, 1"=100' VERT

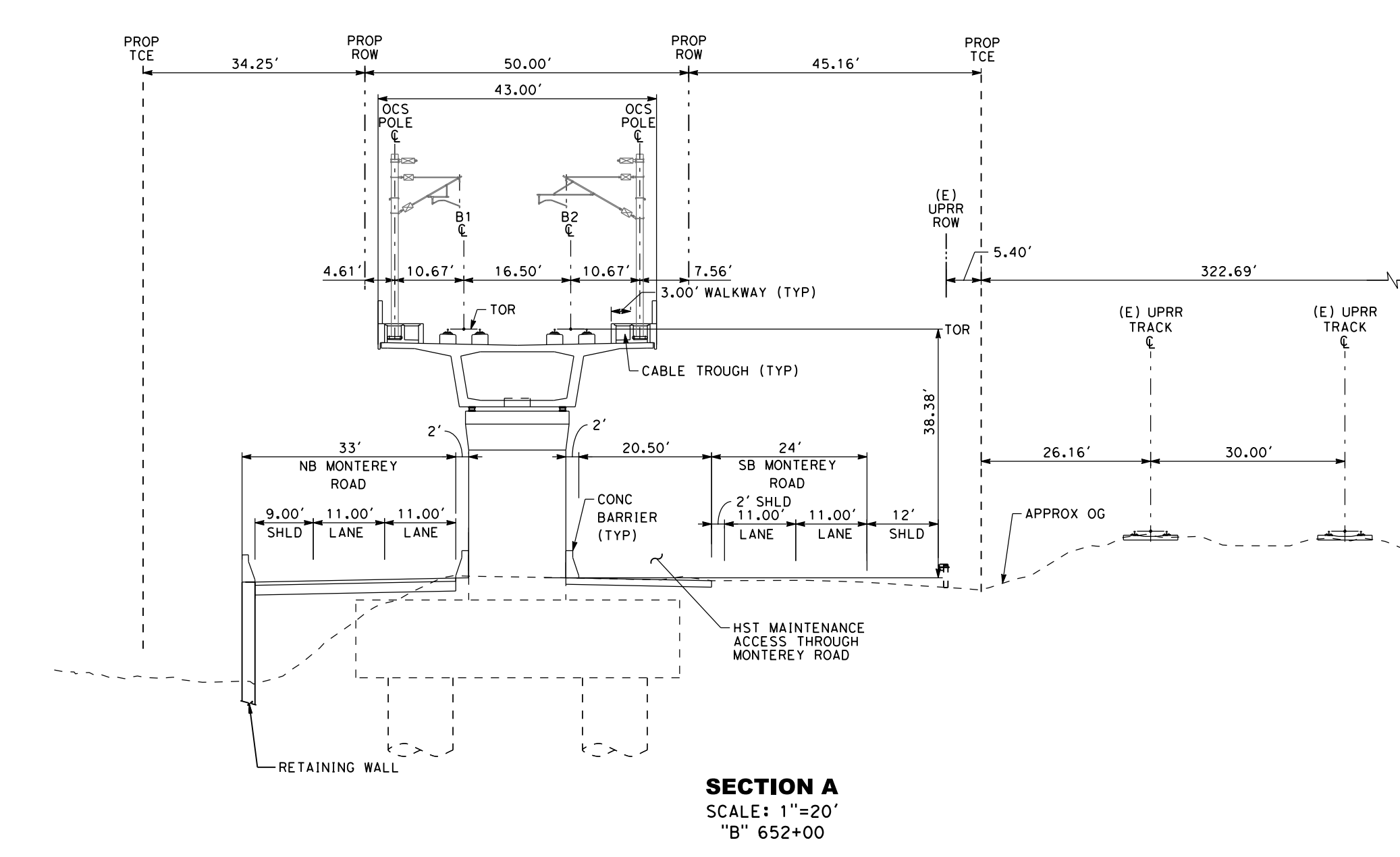

SECTION A
SCALE: 1"=20'
"B" 652+00

- NOTE:**
- REFER TO GENERAL NOTES SHEETS GE-B0001 AND GE-B0002 FOR NOTES.
 - FOR MONTEREY ROAD ALIGNMENT DATA TABLE SEE DRAWING NO. CV-T0101.

SAN JOSE TO CVY EIR/S: VOLUME III
ALTERNATIVE 3
BOOK 3A
SHEET 11 OF 216

RECORD PERM SUBMITTAL MAY 3, 2019 NOT FOR CONSTRUCTION		1111 Broadway 9th Floor Oakland, CA 94607		CALIFORNIA HIGH-SPEED TRAIN PROJECT SAN JOSE TO MERCED MORGAN HILL AND GILROY VIADUCT TO DOWNTOWN GILROY COMPOSITE PLAN, PROFILE AND CROSS SECTIONS B642+00 TO B732+00	CONTRACT NO. HSR15-34 DRAWING NO. TT-D0702 SCALE: AS SHOWN SHEET NO.
--	--	---	--	--	---

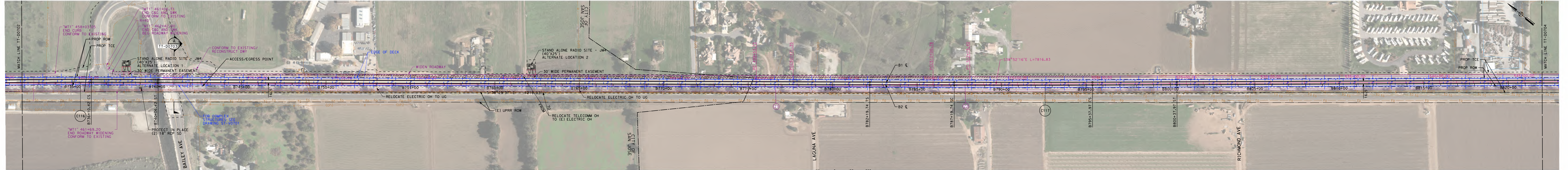

PLAN SCALE: 1"=200'

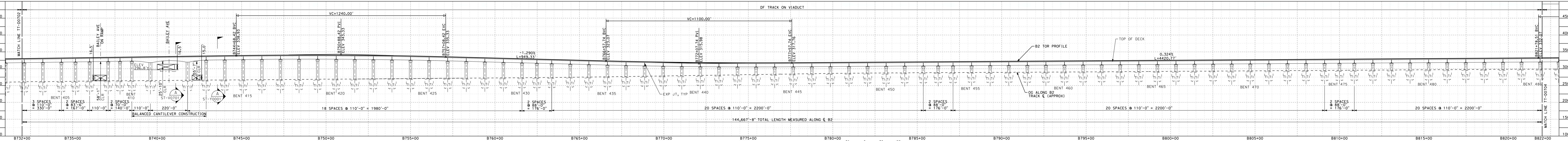

PROFILE SCALE: 1"=200' HOR, 1"=100' VERT

**SAN JOSE TO CVY EIR/S: VOLUME III
ALTERNATIVE 3
BOOK 3A
SHEET 12 OF 216**

- NOTE:**
1. REFER TO GENERAL NOTES SHEETS GE-B0001 AND GE-B0002 FOR NOTES.
 2. FOR MONTEREY ROAD ALIGNMENT DATA TABLE SEE DRAWING NO. CV-T0101

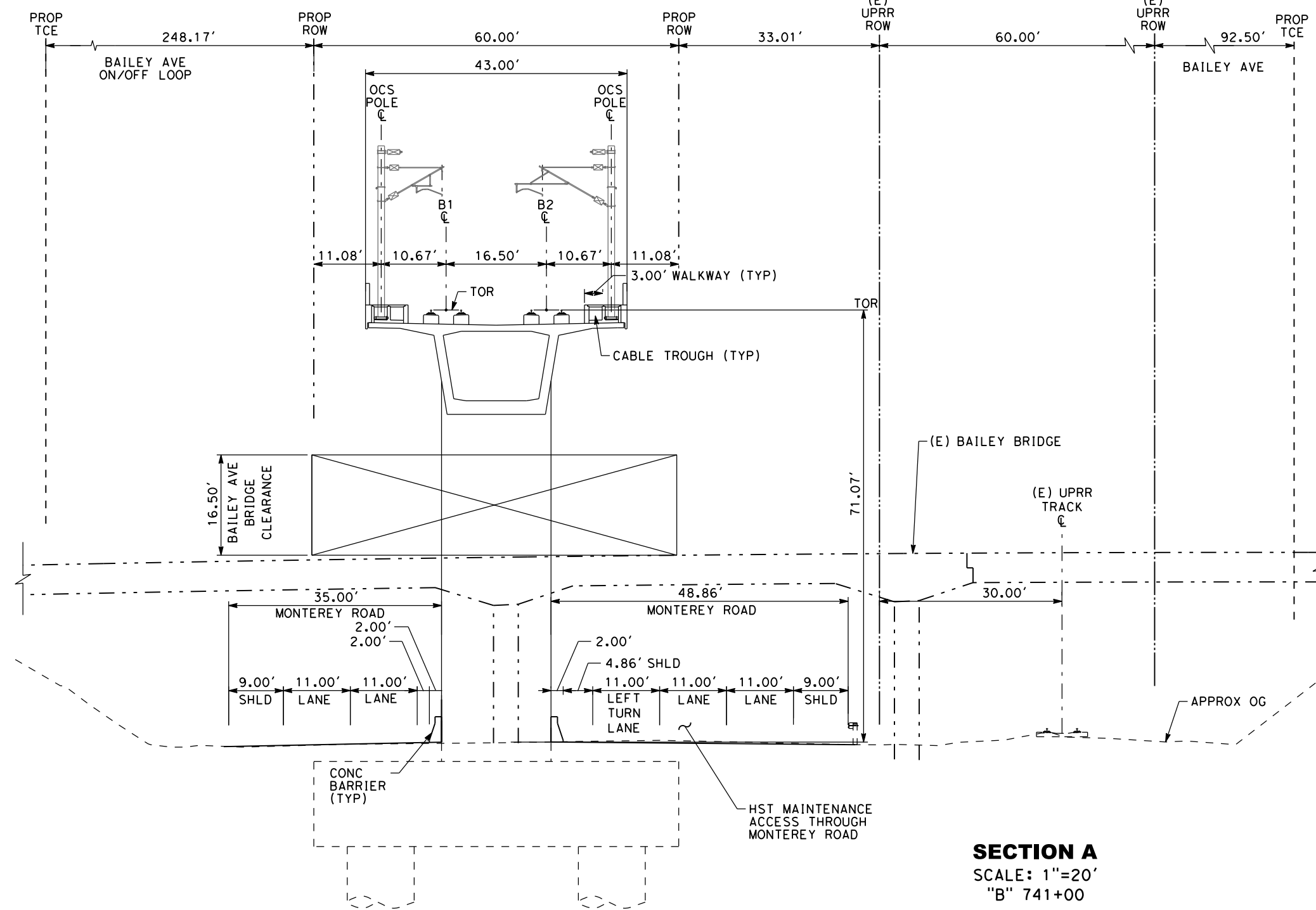

SECTION A SCALE: 1"=20' "B" 741+00

<p>RECORD PERM SUBMITTAL MAY 3, 2019 NOT FOR CONSTRUCTION</p>	<p>HNTB 1111 Broadway 9th Floor Oakland, CA 94607</p>	<p>CALIFORNIA High-Speed Rail Authority</p>	<p>CALIFORNIA HIGH-SPEED TRAIN PROJECT SAN JOSE TO MERCED VIADUCT TO DOWNTOWN GILROY COMPOSITE PLAN, PROFILE AND CROSS SECTIONS B732+00 TO B822+00</p>	<p>CONTRACT NO. HSR15-34 DRAWING NO. TT-D0703 SCALE: AS SHOWN SHEET NO.</p>
---	--	--	---	---

2/20/2019 2:58:53 PM C:\Users\lbr\OneDrive\Documents\SanJose\SanJose\TT-D0703.dwg c:\p\lbr\lbr.ctb 1:200' HOR 1:100' VERT

SANTA CLARA COUNTY

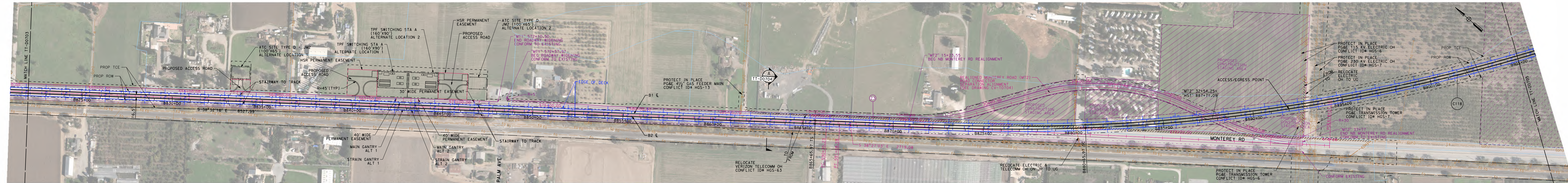

PLAN
SCALE: 1"=200'
1"=200' HOR

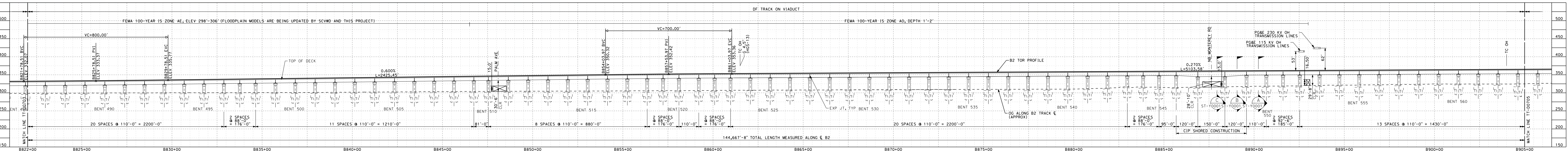

PROFILE
SCALE: 1"=200' HOR, 1"=100' VERT
1"=100' VERT

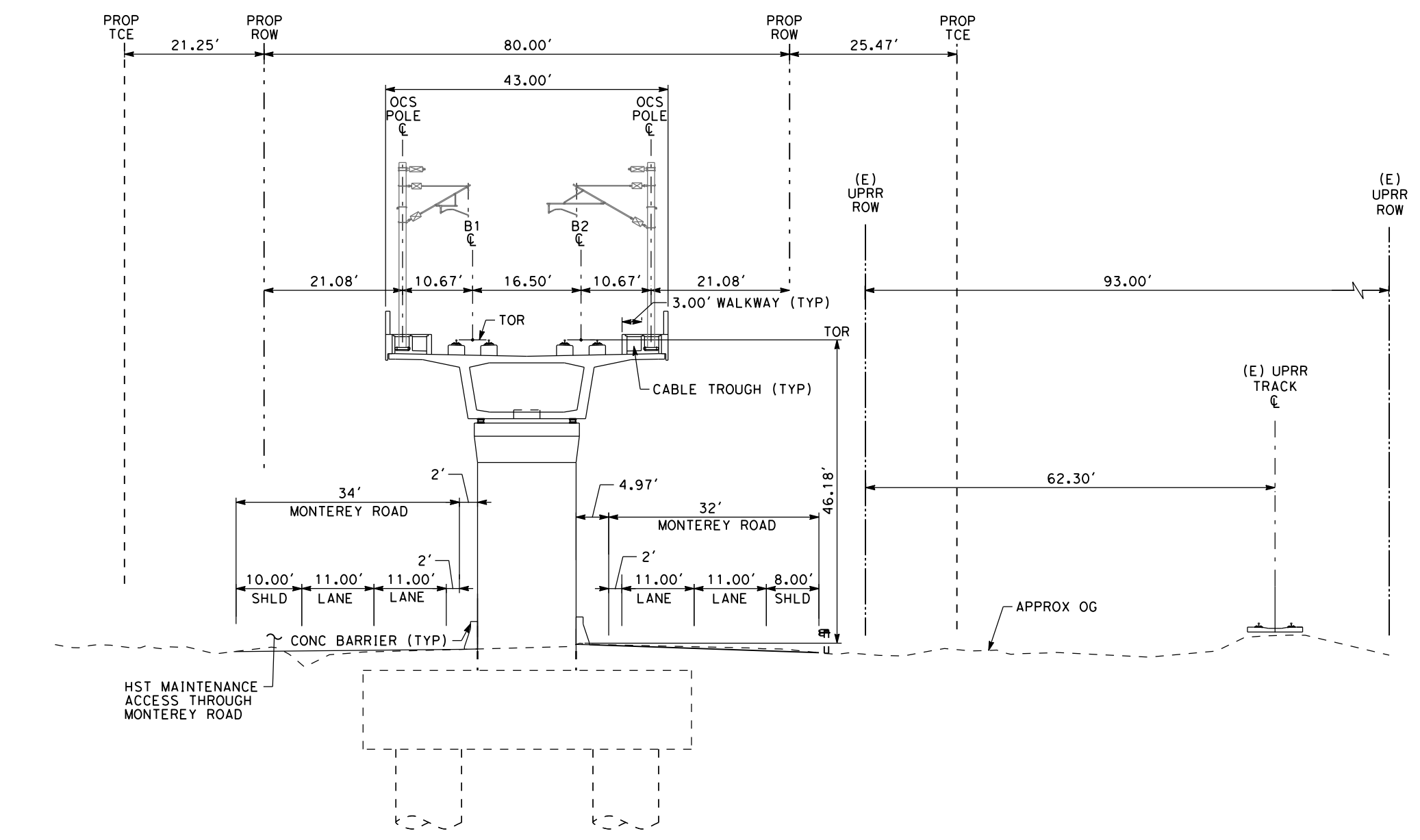

SECTION A
SCALE: 1"=20'
"B" 863+00

- NOTE:
- REFER TO GENERAL NOTES SHEETS GE-B0001 AND GE-B0002 FOR NOTES.
 - FOR MONTEREY ROAD ALIGNMENT DATA TABLE SEE DRAWING NO. CV-T0101

SAN JOSE TO CVY EIR/S: VOLUME III
ALTERNATIVE 3
BOOK 3A
SHEET 13 OF 216

RECORD PERM SUBMITTAL MAY 3, 2019 NOT FOR CONSTRUCTION	1111 Broadway 9th Floor Oakland, CA 94607	CALIFORNIA High-Speed Rail Authority	CALIFORNIA HIGH-SPEED TRAIN PROJECT SAN JOSE TO MERCED MORGAN HILL AND GILROY VIADUCT TO DOWNTOWN GILROY COMPOSITE PLAN, PROFILE AND CROSS SECTIONS B822+00 TO B905+00	CONTRACT NO. HSR15-34 DRAWING NO. TT-D0704 SCALE AS SHOWN SHEET NO.
--	---	--------------------------------------	---	--

SANTA CLARA COUNTY

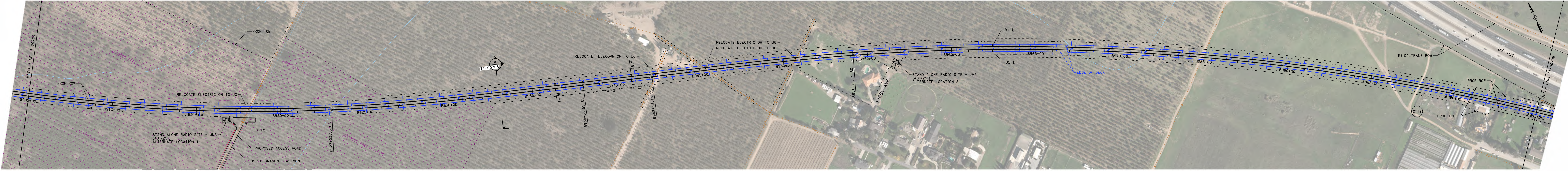

PLAN SCALE: 1"=200'

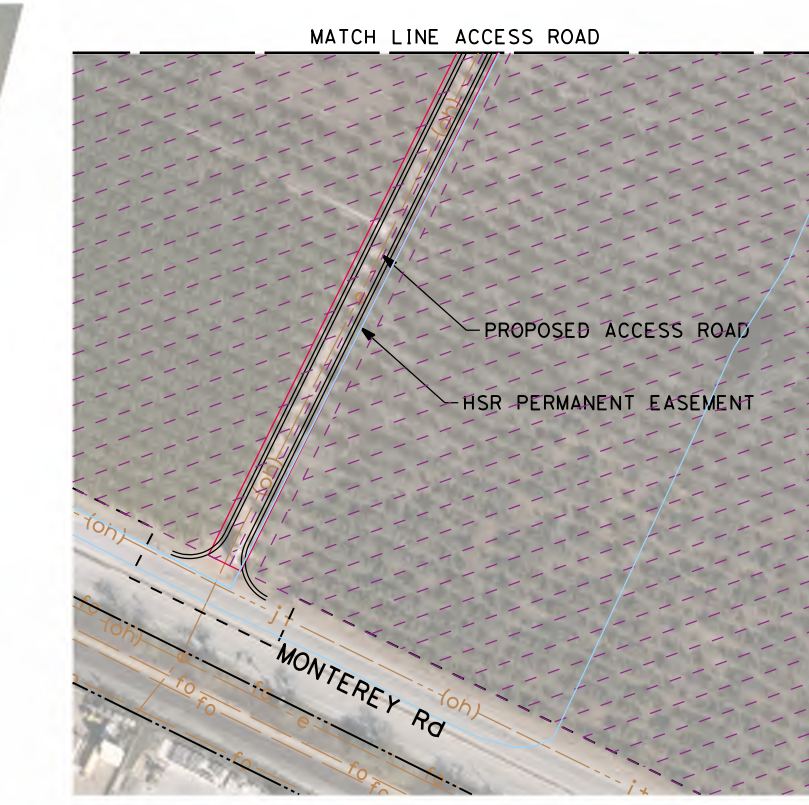

PLAN SCALE: 1"=200'

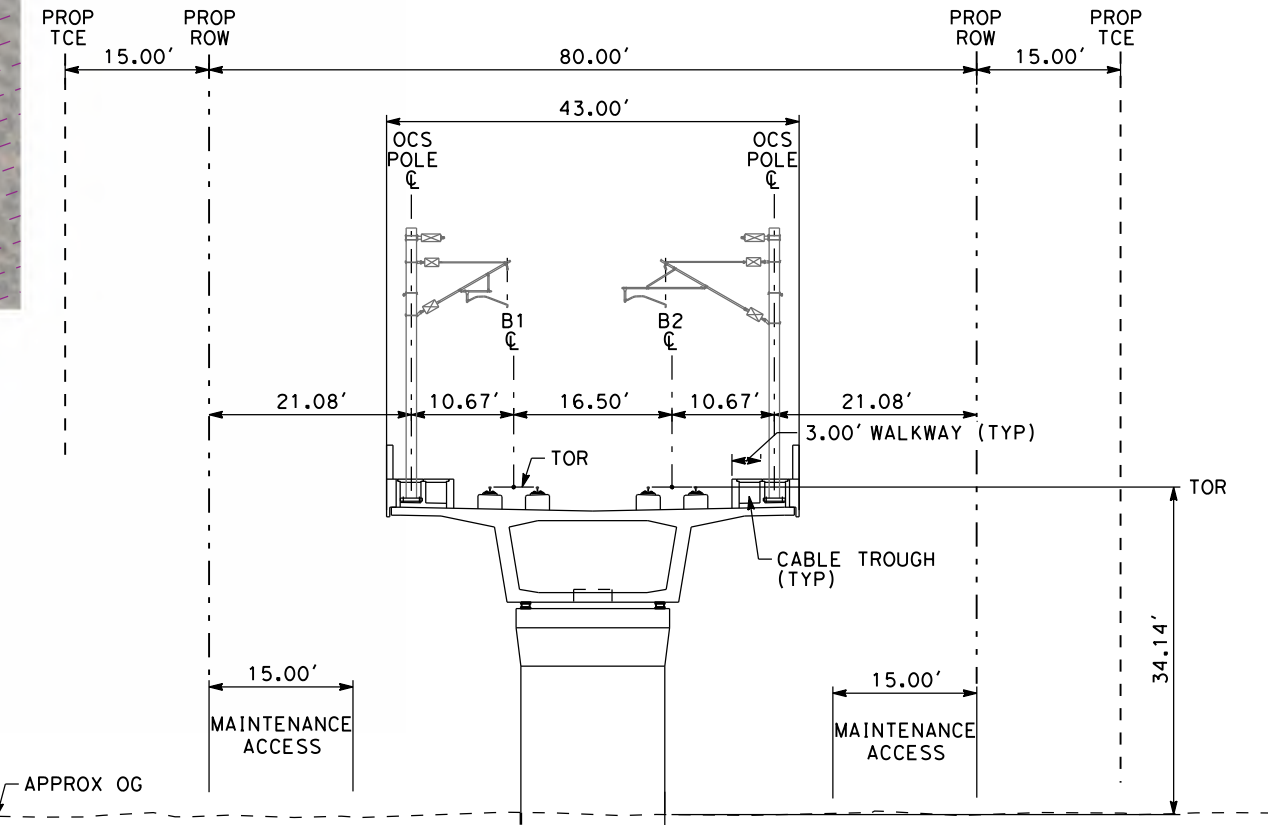

SECTION A SCALE: 1"=20' 'B' 933+00

NOTE:
1. REFER TO GENERAL NOTES SHEETS GE-B0001 AND GE-B0002 FOR NOTES.

SAN JOSE TO CVY EIR/S: VOLUME III
ALTERNATIVE 3
BOOK 3A
SHEET 14 OF 216

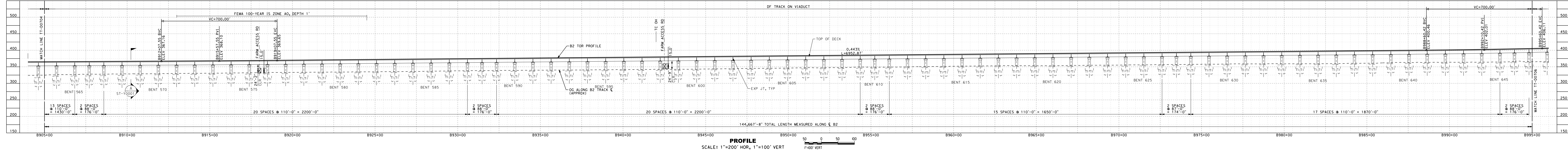

PROFILE SCALE: 1"=200' HOR, 1"=100' VERT

RECORD PERM SUBMITTAL MAY 3, 2019 NOT FOR CONSTRUCTION	HNTB 1111 Broadway 9th Floor Oakland, CA 94607		CALIFORNIA HIGH-SPEED TRAIN PROJECT		CONTRACT NO. HSR15-34
			SAN JOSE TO MERCED		DRAWING NO. TT-D0705
			VIADUCT TO DOWNTOWN GILROY		SCALE AS SHOWN
			COMPOSITE PLAN, PROFILE AND CROSS SECTIONS B905+00 TO B995+00		SHEET NO.

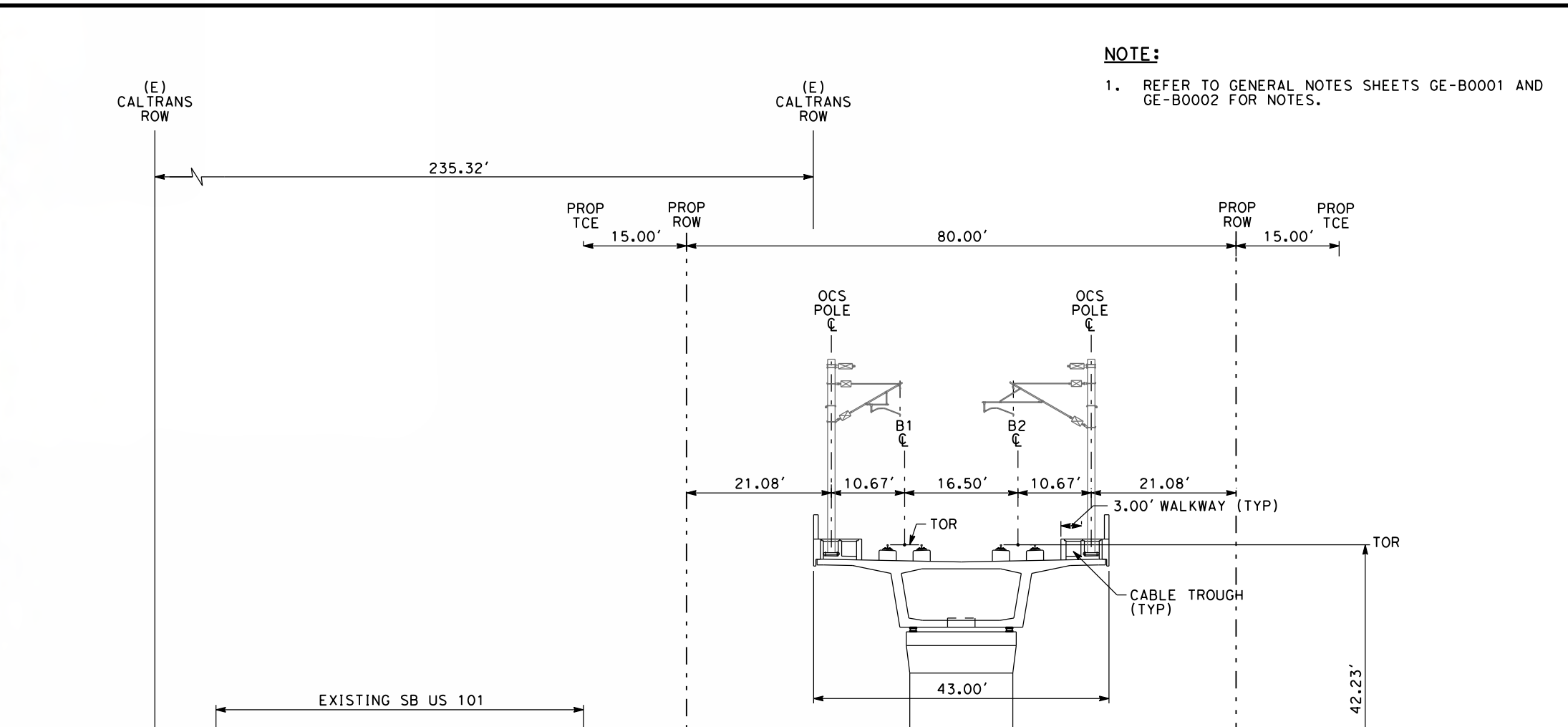
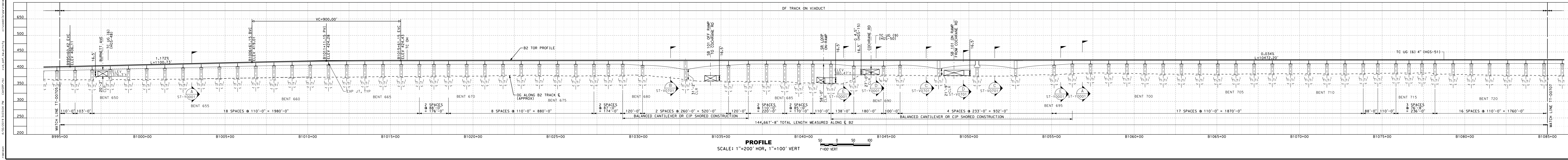
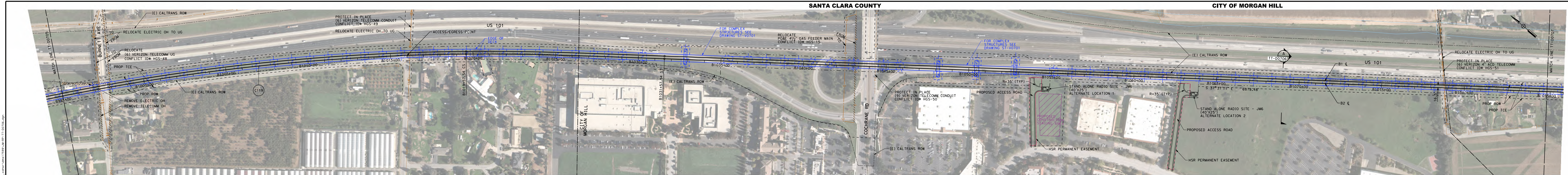

SAN JOSE TO CVY EIR/S: VOLUME III
ALTERNATIVE 3
BOOK 3A
SHEET 15 OF 216

NOTE:
1. REFER TO GENERAL NOTES SHEETS GE-B0001 AND GE-B0002 FOR NOTES.

2/20/2019 2:05:04 PM C:\p0001\Drawings\19395\19395.dwg User: j19395 Date: 11/20/19 10:06:39
 2/20/2019 2:05:04 PM C:\p0001\Drawings\19395\19395.dwg User: j19395 Date: 11/20/19 10:06:39
 2/20/2019 2:05:04 PM C:\p0001\Drawings\19395\19395.dwg User: j19395 Date: 11/20/19 10:06:39

RECORD PERM SUBMITTAL MAY 3, 2019 NOT FOR CONSTRUCTION	HNTB 1111 Broadway 9th Floor Oakland, CA 94607		CALIFORNIA HIGH-SPEED TRAIN PROJECT SAN JOSE TO MERCED VIADUCT TO DOWNTOWN GILROY COMPOSITE PLAN, PROFILE AND CROSS SECTIONS B995+00 TO B1085+00	CONTRACT NO. HSR15-34 DRAWING NO. TT-D0706 SCALE: AS SHOWN SHEET NO.
---	--	--	--	---

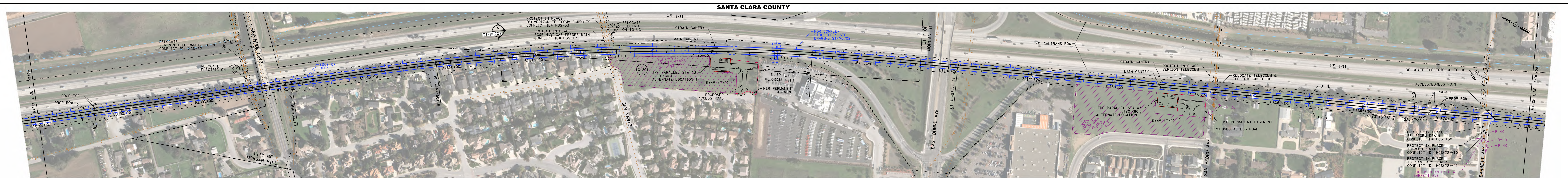

PLAN
SCALE: 1"=200'
1"=200' HOR

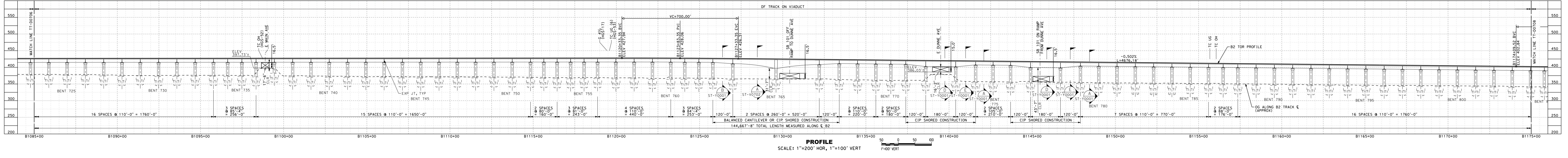

PROFILE
SCALE: 1"=200' HOR, 1"=100' VERT
1"=100' VERT

NOTE:
1. REFER TO GENERAL NOTES SHEETS GE-B0001 AND GE-B0002 FOR NOTES.

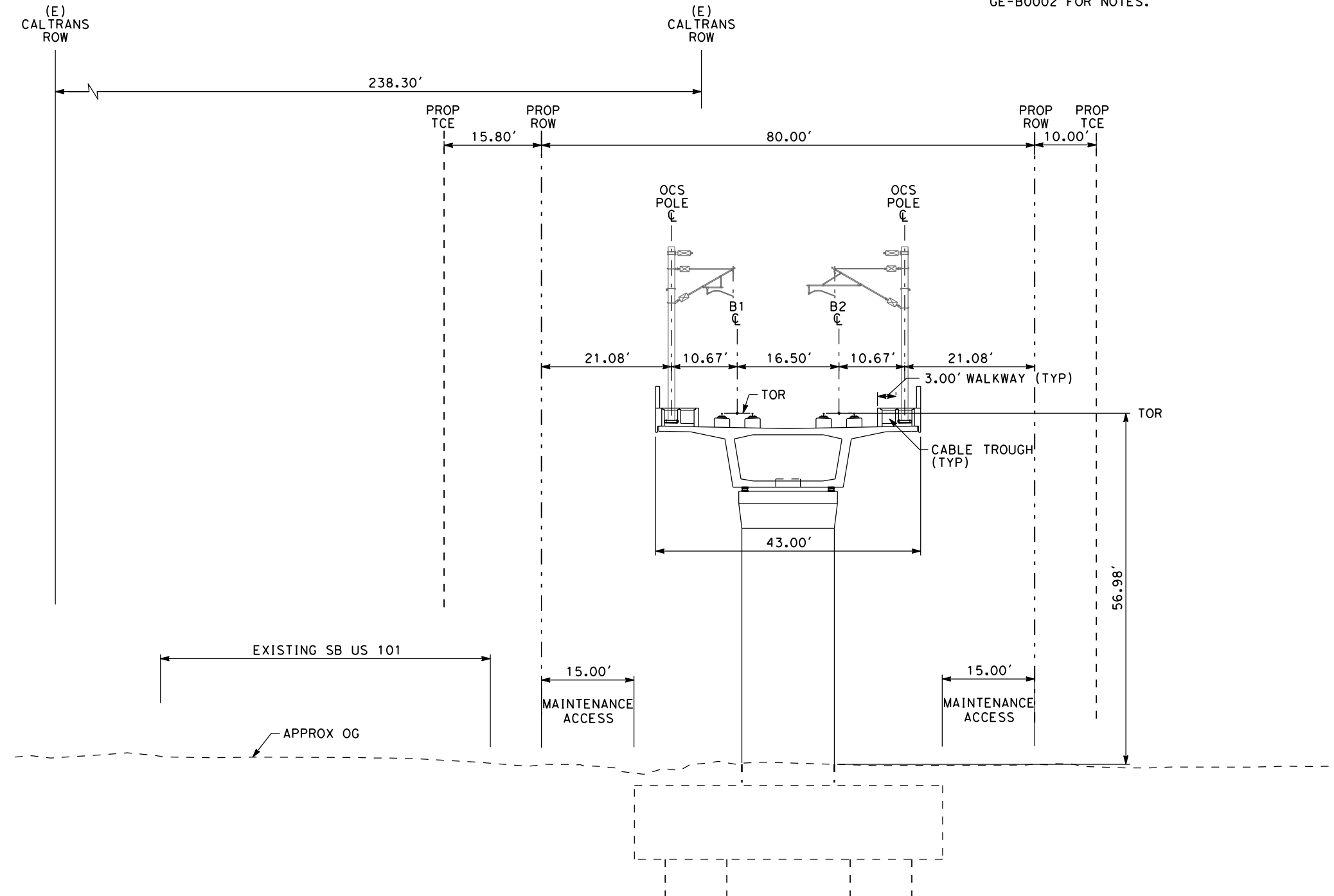

SAN JOSE TO CVY EIR/S: VOLUME III
ALTERNATIVE 3
BOOK 3A
SHEET 16 OF 216

SECTION A
SCALE: 1"=20'
"B" 1113+00

<p>RECORD PERM SUBMITTAL MAY 3, 2019 NOT FOR CONSTRUCTION</p>	<p>HNTB 1111 Broadway 9th Floor Oakland, CA 94607</p>	<p>CALIFORNIA High-Speed Rail Authority</p>	<p>CALIFORNIA HIGH-SPEED TRAIN PROJECT SAN JOSE TO MERCED MORGAN HILL AND GILROY VIADUCT TO DOWNTOWN GILROY COMPOSITE PLAN, PROFILE AND CROSS SECTIONS B1085+00 TO B1175+00</p>	<p>CONTRACT NO. HSR15-34 DRAWING NO. TT-D0707 SCALE AS SHOWN SHEET NO.</p>
---	--	--	--	--

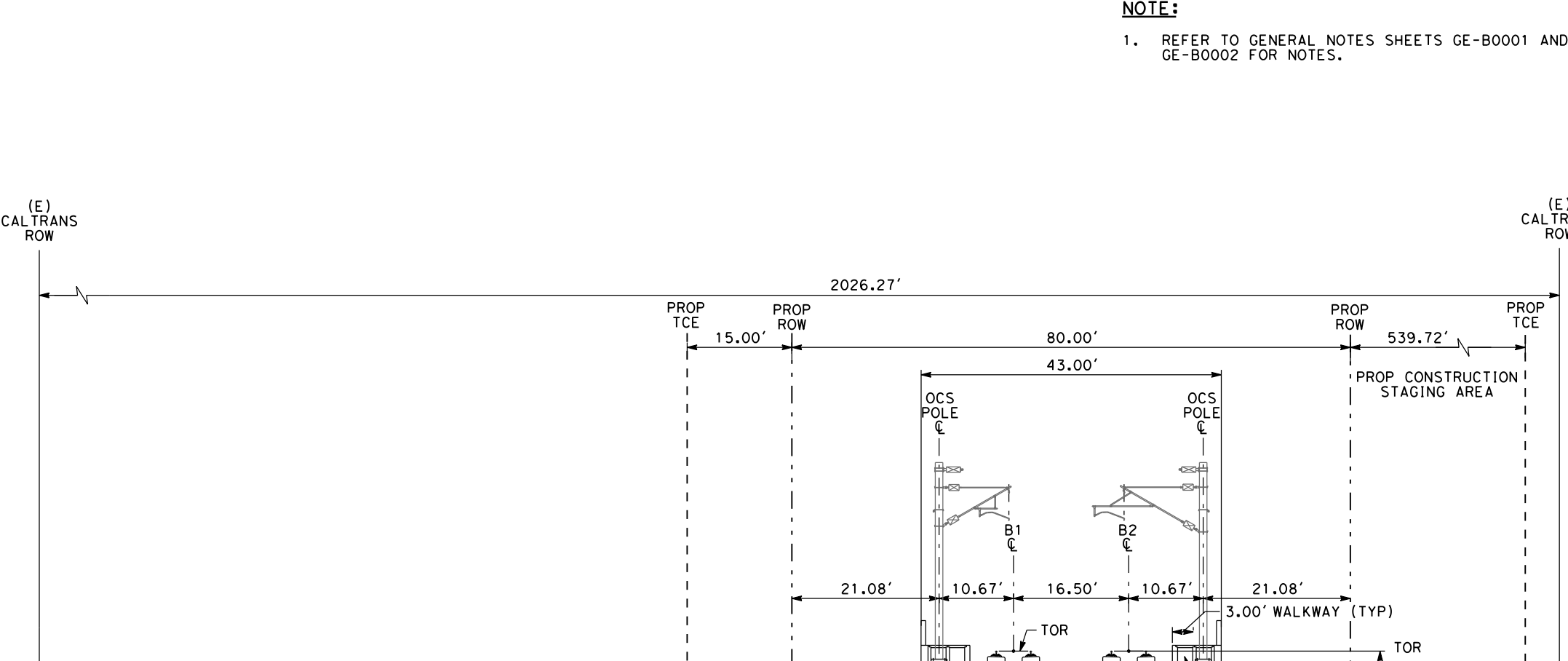



NOTE:
1. REFER TO GENERAL NOTES SHEETS GE-B0001 AND GE-B0002 FOR NOTES.

**SAN JOSE TO CVY EIR/S: VOLUME III
ALTERNATIVE 3
BOOK 3A
SHEET 17 OF 216**

**SECTION A
SCALE: 1"=20'
"B" 1189+00**

RECORD PERM SUBMITTAL MAY 3, 2019 NOT FOR CONSTRUCTION	HNTB 1111 Broadway 9th Floor Oakland, CA 94607	CALIFORNIA High-Speed Rail Authority	CALIFORNIA HIGH-SPEED TRAIN PROJECT SAN JOSE TO MERCED MORGAN HILL AND GILROY VIADUCT TO DOWNTOWN GILROY COMPOSITE PLAN, PROFILE AND CROSS SECTIONS B1175+00 TO B1265+00	CONTRACT NO. HSR15-34 DRAWING NO. TT-D0708 SCALE AS SHOWN SHEET NO.
--	--	--	---	--

SANTA CLARA COUNTY

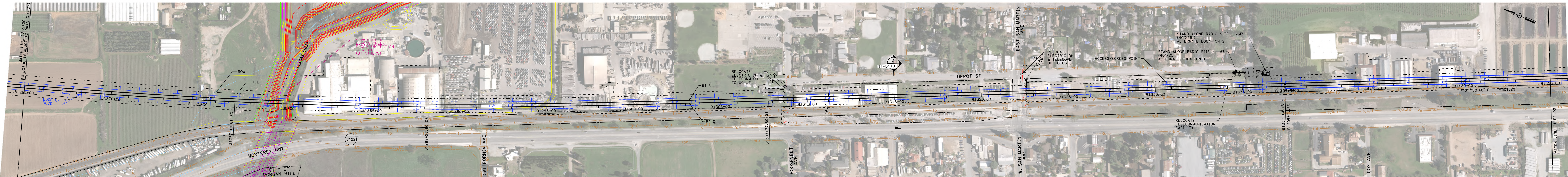

PLAN
SCALE: 1"=200'
1"=200' HOR

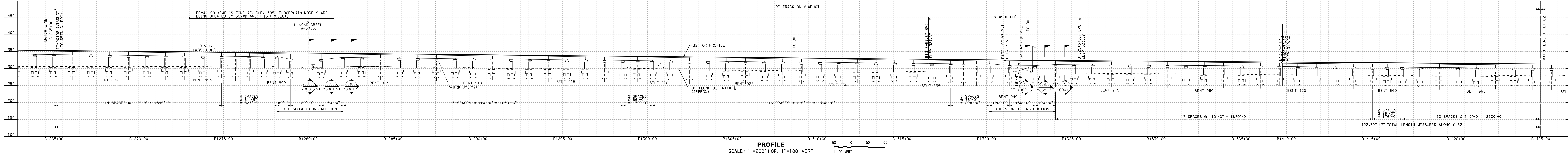

PROFILE
SCALE: 1"=200' HOR, 1"=100' VERT
1"=100' VERT

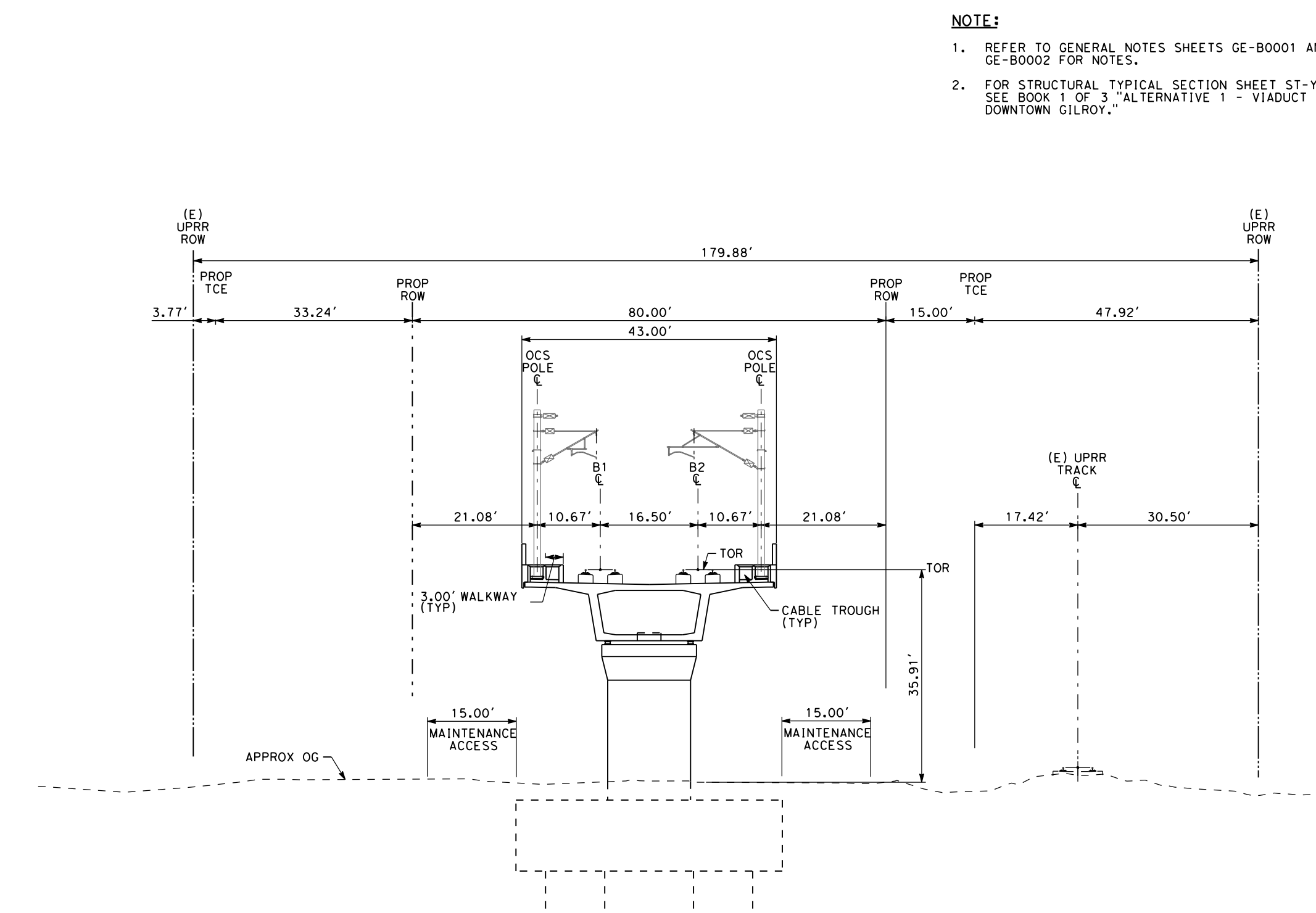

SECTION A
SCALE: 1"=20'
"B" 1315+00

- NOTE:**
1. REFER TO GENERAL NOTES SHEETS GE-B0001 AND GE-B0002 FOR NOTES.
 2. FOR STRUCTURAL TYPICAL SECTION SHEET ST-Y0001, SEE BOOK 1 OF 3 "ALTERNATIVE 1 - VIADUCT TO DOWNTOWN GILROY."

SAN JOSE TO CVY EIR/S: VOLUME III
ALTERNATIVE 3
BOOK 3A
SHEET 18 OF 216

2/26/2019 2:48:06 PM C:\Users\jbr\OneDrive\Documents\40337_Comp\Sheet\1826_Vol3A_S18 of 216.dwg
 2/26/2019 2:48:06 PM C:\Users\jbr\OneDrive\Documents\40337_Comp\Sheet\1826_Vol3A_S18 of 216.dwg
 2/26/2019 2:48:06 PM C:\Users\jbr\OneDrive\Documents\40337_Comp\Sheet\1826_Vol3A_S18 of 216.dwg

RECORD PERM SUBMITTAL MAY 3, 2019 NOT FOR CONSTRUCTION	1111 Broadway 9th Floor Oakland, CA 94607	CALIFORNIA High-Speed Rail Authority	CALIFORNIA HIGH-SPEED TRAIN PROJECT SAN JOSE TO MERCED MORGAN HILL AND GILROY VIADUCT TO EAST GILROY COMPOSITE PLAN, PROFILE AND CROSS SECTIONS B1265+00 TO B1425+00	CONTRACT NO. HSR15-34 DRAWING NO. TT-D1101 SCALE AS SHOWN SHEET NO.
--	---	--------------------------------------	--	--

SANTA CLARA COUNTY

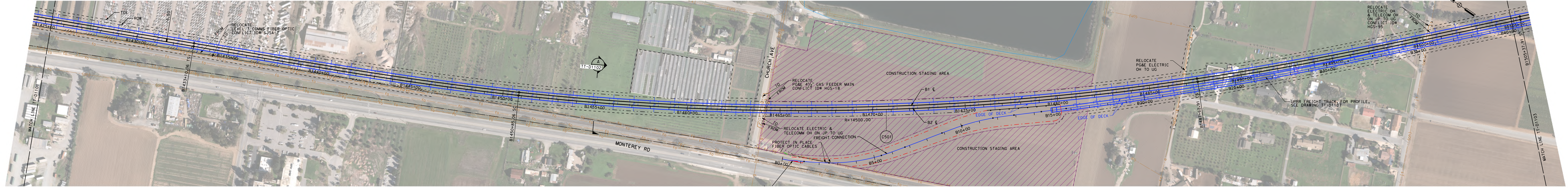

PLAN
SCALE: 1"=200'
1"=200' HOR

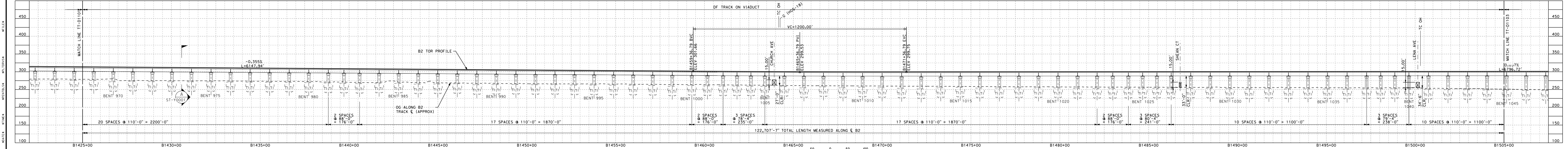

PROFILE
SCALE: 1"=200' HOR, 1"=100' VERT
1"=100' VERT

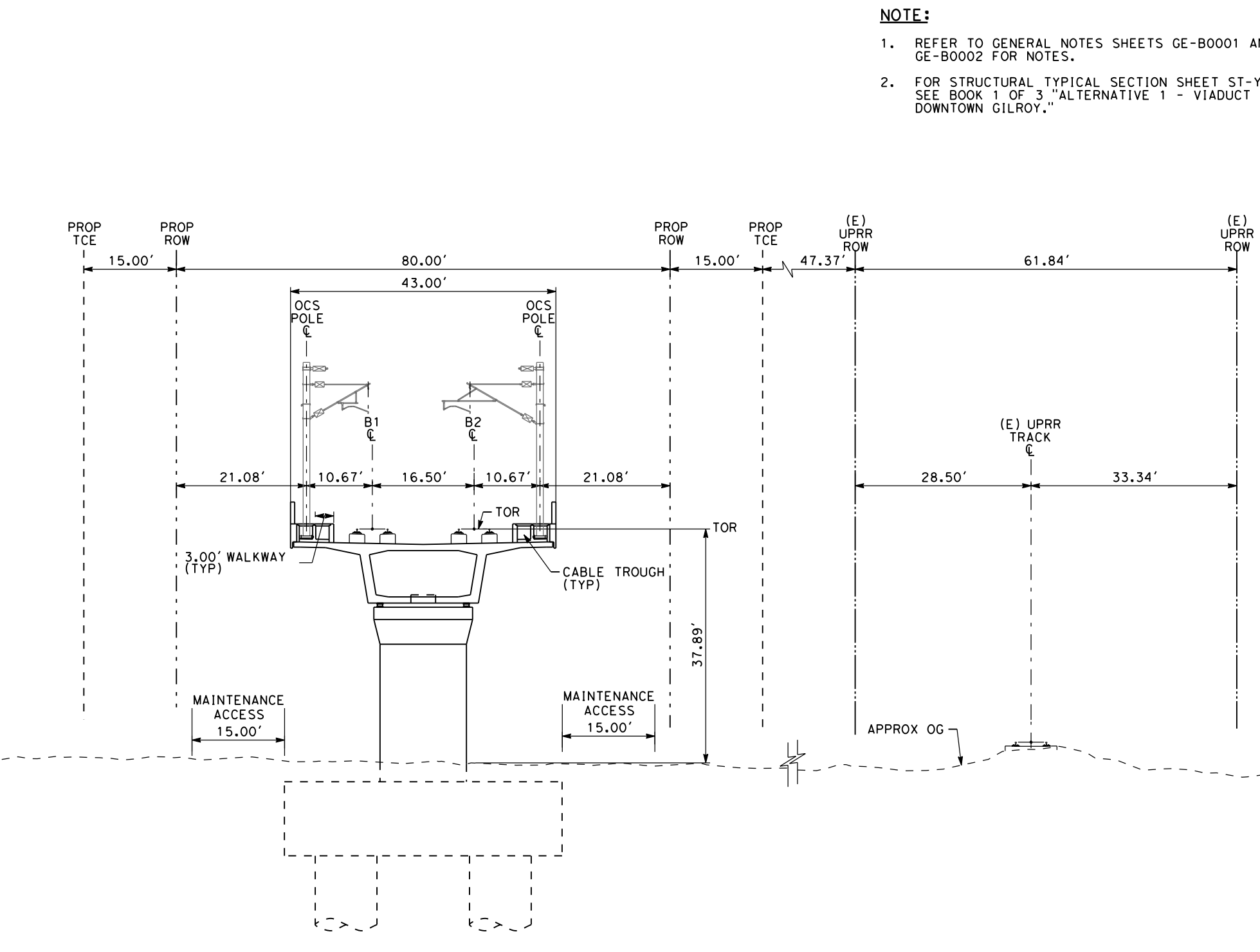

SECTION A
SCALE: 1"=20'
"B" 1455+00

- NOTE:**
- REFER TO GENERAL NOTES SHEETS GE-B0001 AND GE-B0002 FOR NOTES.
 - FOR STRUCTURAL TYPICAL SECTION SHEET ST-Y0001, SEE BOOK 1 OF 3 "ALTERNATIVE 1 - VIADUCT TO DOWNTOWN GILROY."

SAN JOSE TO CVY EIR/S: VOLUME III
ALTERNATIVE 3
BOOK 3A
SHEET 19 OF 216

RECORD PERM SUBMITTAL MAY 3, 2019 NOT FOR CONSTRUCTION	HNTB 1111 Broadway 9th Floor Oakland, CA 94607	CALIFORNIA High-Speed Rail Authority	CALIFORNIA HIGH-SPEED TRAIN PROJECT SAN JOSE TO MERCED MORGAN HILL AND GILROY VIADUCT TO EAST GILROY COMPOSITE PLAN, PROFILE AND CROSS SECTIONS B1425+00 TO B1505+00	CONTRACT NO. HSR15-34 DRAWING NO. TT-D1102 SCALE AS SHOWN SHEET NO.
--	--	--	--	--



PLAN
SCALE: 1"=200'



PROFILE
SCALE: 1"=200' HOR, 1"=100' VERT

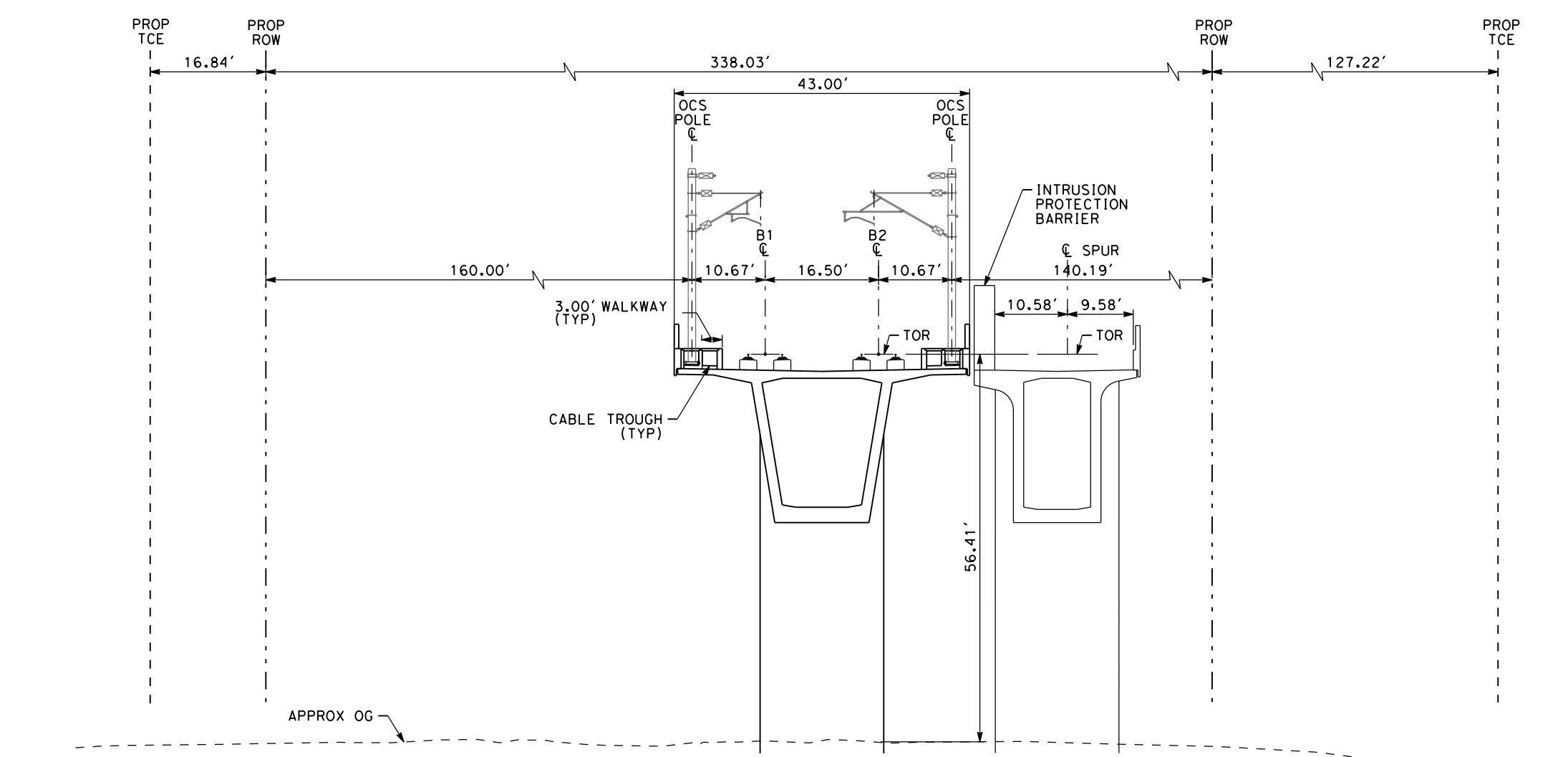

SECTION A
SCALE: 1"=20'
"B" 1535+00

- NOTE:**
- REFER TO GENERAL NOTES SHEETS GE-B0001 AND GE-B0002 FOR NOTES.
 - FOR STRUCTURAL TYPICAL SECTION SHEET ST-Y0001, SEE BOOK 1 OF 3 "ALTERNATIVE 1 - VIADUCT TO DOWNTOWN GILROY."

SAN JOSE TO CVY EIR/S: VOLUME III
ALTERNATIVE 3
BOOK 3A
SHEET 20 OF 216

<p>RECORD PERM SUBMITTAL MAY 3, 2019 NOT FOR CONSTRUCTION</p>	<p>HNTB 1111 Broadway 9th Floor Oakland, CA 94607</p>	<p>CALIFORNIA High-Speed Rail Authority</p>	<p>CALIFORNIA HIGH-SPEED TRAIN PROJECT SAN JOSE TO MERCED VIADUCT TO EAST GILROY COMPOSITE PLAN, PROFILE AND CROSS SECTIONS B1505+00 TO B1594+00</p>	<p>CONTRACT NO. HSR15-34 DRAWING NO. TT-D1103 SCALE: AS SHOWN SHEET NO.</p>
---	--	--	--	---

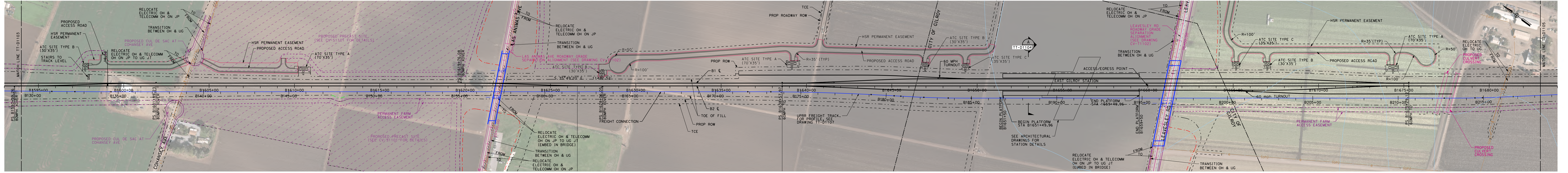

PLAN SCALE: 1"=200'

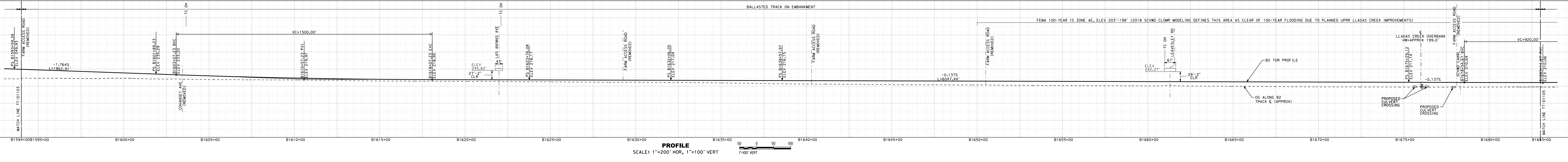

PROFILE SCALE: 1"=200' HOR, 1"=100' VERT

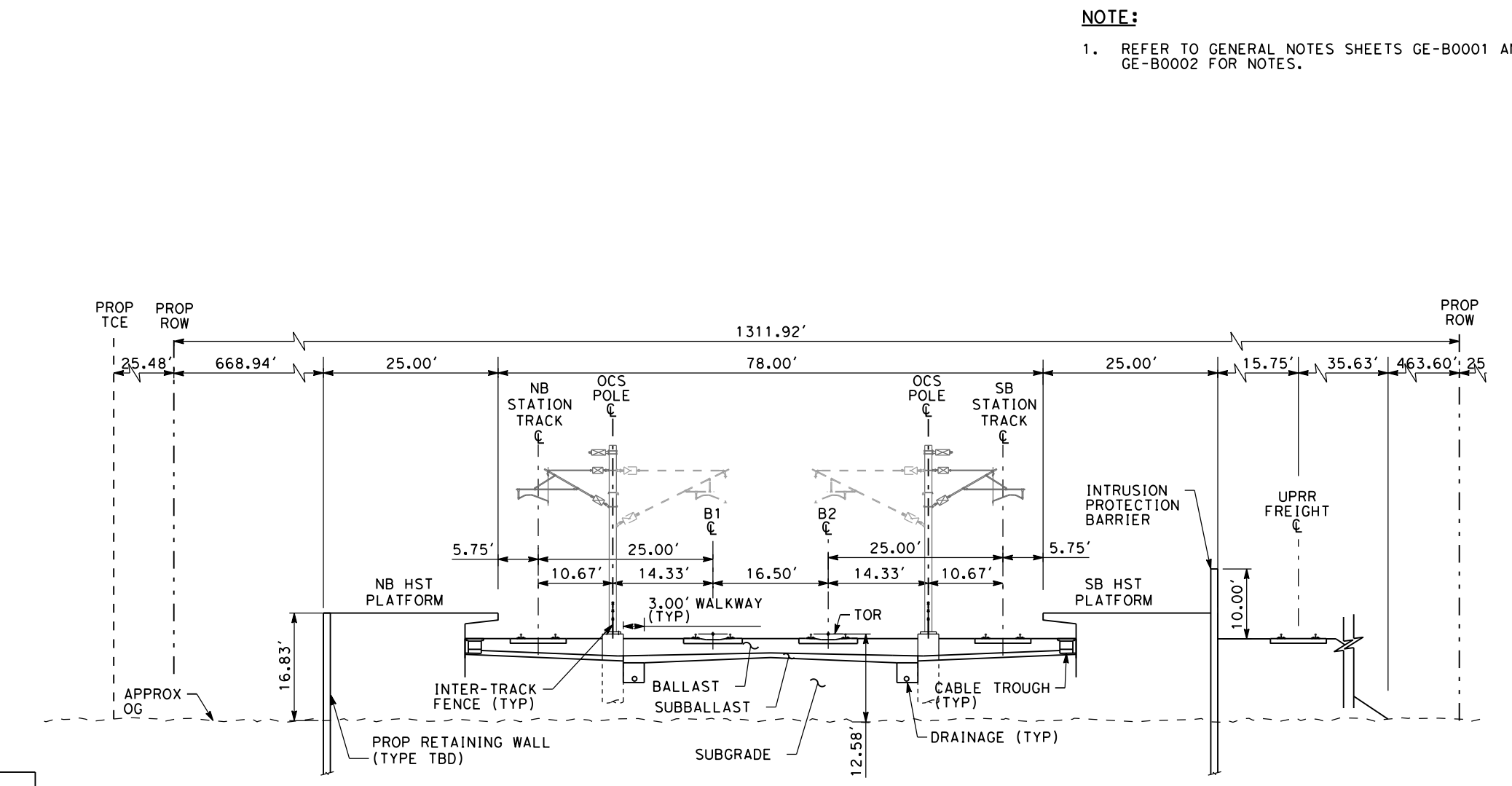

SECTION A SCALE: 1"=20' "B" 1653+00

NOTE:
1. REFER TO GENERAL NOTES SHEETS GE-B0001 AND GE-B0002 FOR NOTES.

**SAN JOSE TO CVY EIR/S: VOLUME III
ALTERNATIVE 3
BOOK 3A
SHEET 21 OF 216**

RECORD PERM SUBMITTAL MAY 3, 2019 NOT FOR CONSTRUCTION		1111 Broadway 9th Floor Oakland, CA 94607		CALIFORNIA HIGH-SPEED TRAIN PROJECT SAN JOSE TO MERCED MORGAN HILL AND GILROY VIADUCT TO EAST GILROY COMPOSITE PLAN, PROFILE AND CROSS SECTIONS B1594+00 TO B1683+00	CONTRACT NO. HSR15-34 DRAWING NO. TT-D1104 SCALE AS SHOWN SHEET NO.
--	--	---	--	---	--

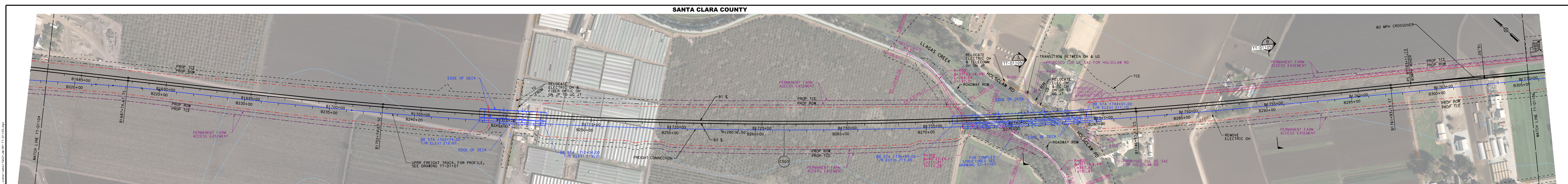

PLAN
SCALE: 1"=200'
1"=200' HOR

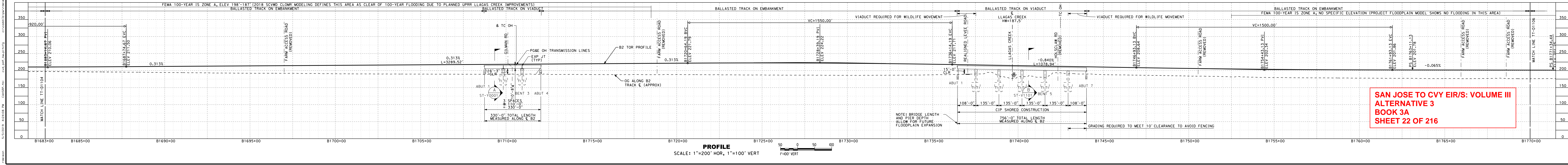

PROFILE
SCALE: 1"=200' HOR, 1"=100' VERT
1"=100' VERT

**SAN JOSE TO CVY EIR/S: VOLUME III
ALTERNATIVE 3
BOOK 3A
SHEET 22 OF 216**

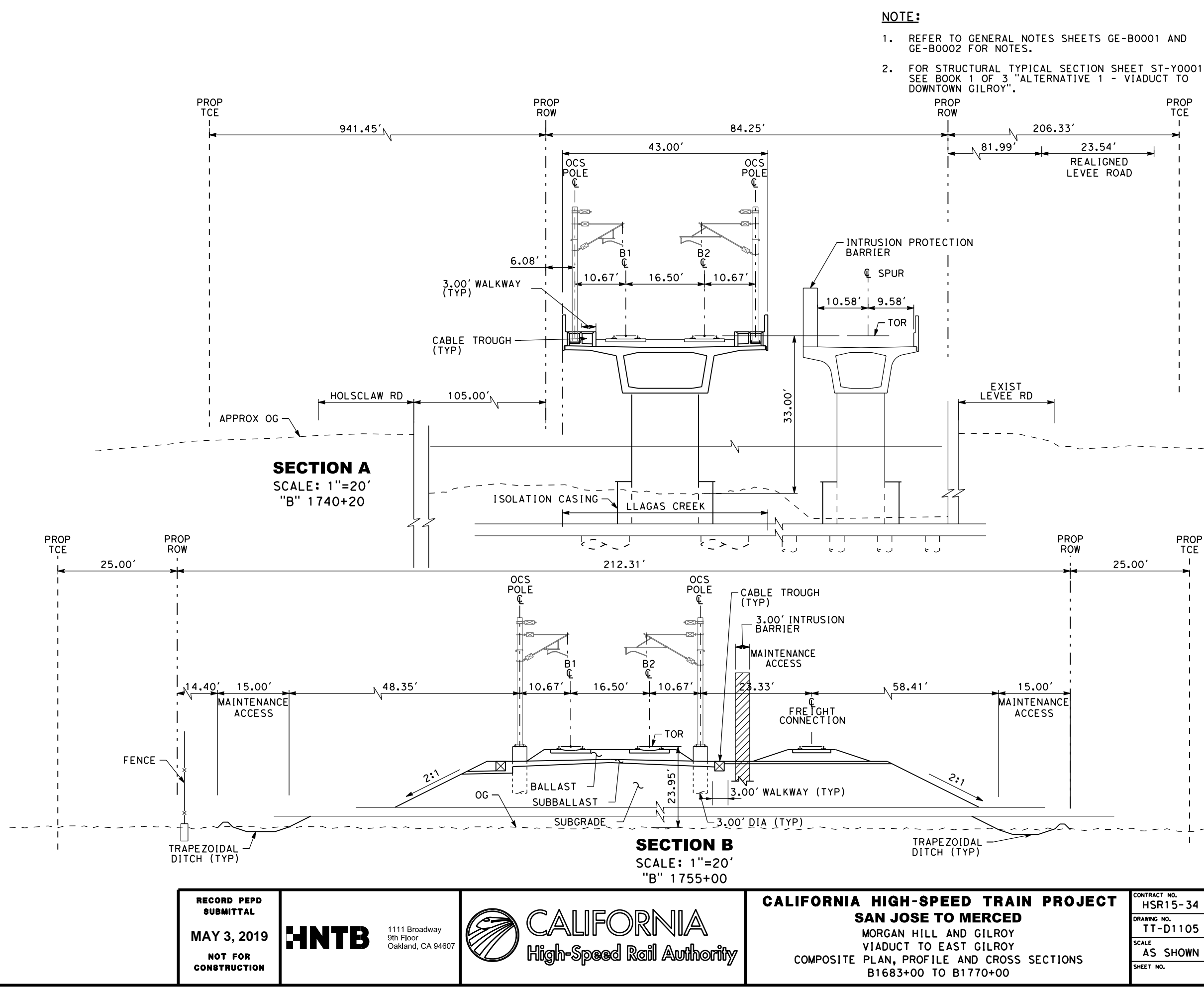

SECTION A
SCALE: 1"=20'
"B" 1740+20

SECTION B
SCALE: 1"=20'
"B" 1755+00

- NOTE:**
- REFER TO GENERAL NOTES SHEETS GE-B0001 AND GE-B0002 FOR NOTES.
 - FOR STRUCTURAL TYPICAL SECTION SHEET ST-Y0001, SEE BOOK 1 OF 3 "ALTERNATIVE 1 - VIADUCT TO DOWNTOWN GILROY".

RECORD PERM SUBMITTAL MAY 3, 2019	HNTB 1111 Broadway 9th Floor Oakland, CA 94607	CALIFORNIA High-Speed Rail Authority	CALIFORNIA HIGH-SPEED TRAIN PROJECT SAN JOSE TO MERCED MORGAN HILL AND GILROY VIADUCT TO EAST GILROY COMPOSITE PLAN, PROFILE AND CROSS SECTIONS B1683+00 TO B1770+00	CONTRACT NO. HSR15-34 DRAWING NO. TT-D1105 SCALE AS SHOWN SHEET NO.
---	--	--	--	---

SANTA CLARA COUNTY

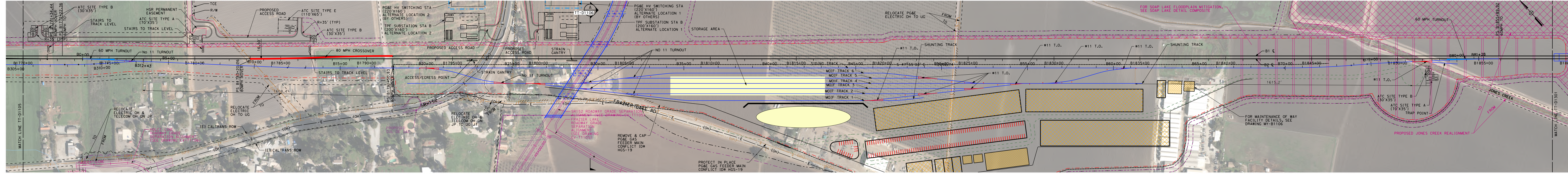

PLAN
SCALE: 1"=200'

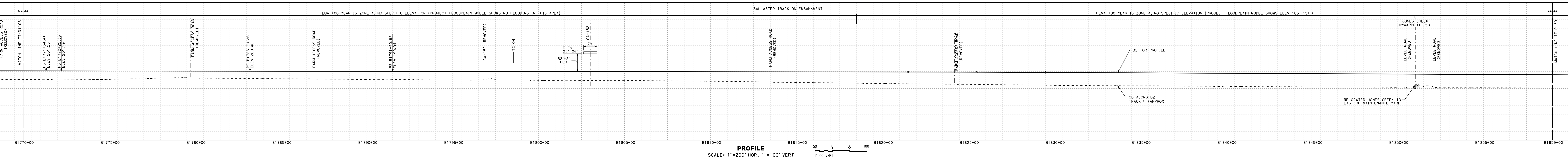

PROFILE
SCALE: 1"=200' HOR, 1"=100' VERT

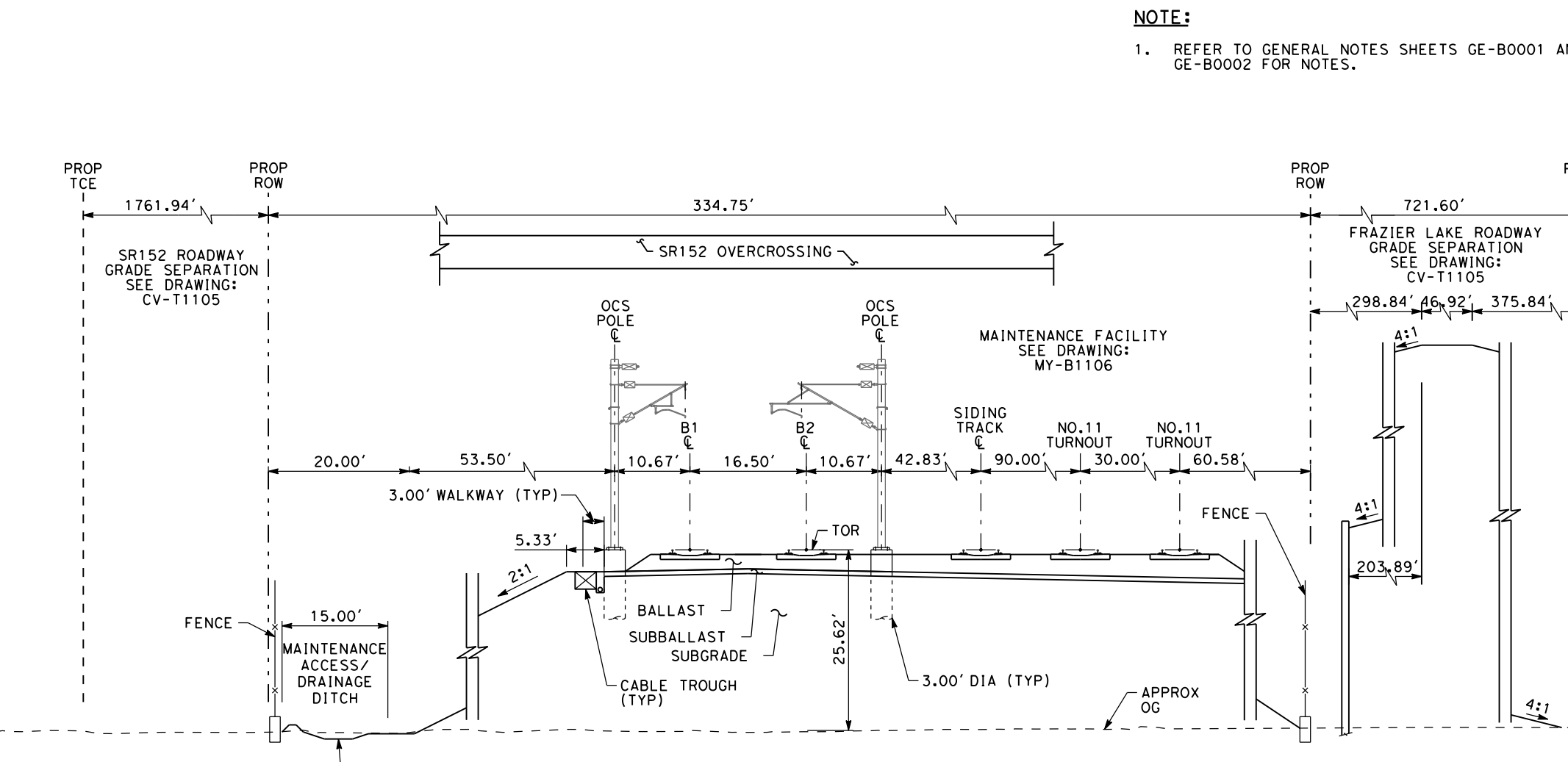

SECTION A
SCALE: 1"=20'
"B" 1803+00

NOTE:
1. REFER TO GENERAL NOTES SHEETS GE-B0001 AND GE-B0002 FOR NOTES.

SAN JOSE TO CVY EIR/S: VOLUME III
ALTERNATIVE 3
BOOK 3A
SHEET 23 OF 216

<p>RECORD PERM SUBMITTAL MAY 3, 2019 NOT FOR CONSTRUCTION</p>	<p>HNTB 1111 Broadway 9th Floor Oakland, CA 94607</p>	<p>CALIFORNIA High-Speed Rail Authority</p>	<p>CALIFORNIA HIGH-SPEED TRAIN PROJECT SAN JOSE TO MERCED VIADUCT TO EAST GILROY COMPOSITE PLAN, PROFILE AND CROSS SECTIONS B1770+00 TO B1859+00</p>	<p>CONTRACT NO. HSR15-34 DRAWING NO. TT-D1106 SCALE: AS SHOWN SHEET NO.</p>
---	--	--	--	---

NOTE:
 1. SEE DRAWING No. TT-D1105 FOR MOWF LAYOUT.
 2. SEE COMPOSITE TT DRAWINGS FOR UPRR TRACK ALIGNMENT.



PROFILE
 SCALE: 1"=200' HOR, 1"=100' VERT



PROFILE
 SCALE: 1"=200' HOR, 1"=100' VERT



PROFILE
 SCALE: 1"=200' HOR, 1"=100' VERT

SAN JOSE TO CVY EIR/IS: VOLUME III
ALTERNATIVE 3
BOOK 3A
SHEET 24 OF 216

RECORD PERM SUBMITTAL MAY 3, 2019 NOT FOR CONSTRUCTION		1111 Broadway 9th Floor Oakland, CA 94607		CALIFORNIA HIGH-SPEED TRAIN PROJECT SAN JOSE TO MERCED MORGAN HILL AND GILROY VIADUCT TO EAST GILROY UPRR FREIGHT TRACK PROFILE	CONTRACT NO. HSR15-34 DRAWING NO. TT-D1107 SCALE AS SHOWN SHEET NO.
--	--	---	--	---	---

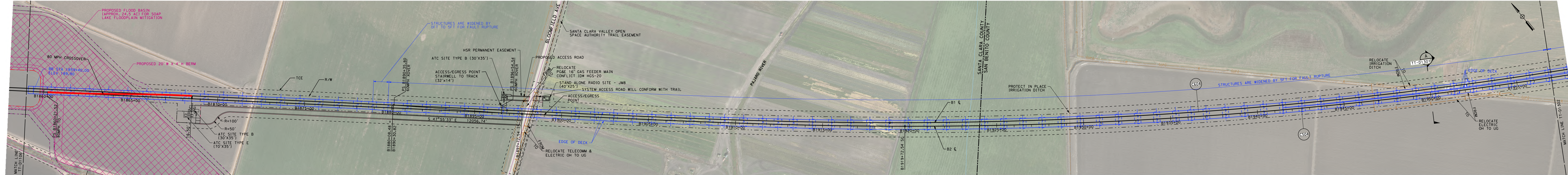

PLAN SCALE: 1"=200' 1"=200' HOR

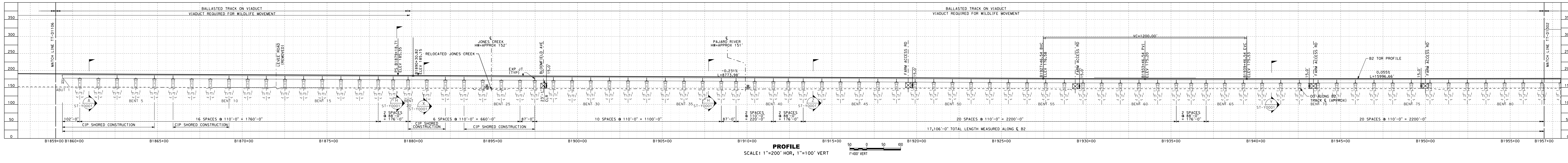

PROFILE SCALE: 1"=200' HOR, 1"=100' VERT 1"=100' VERT

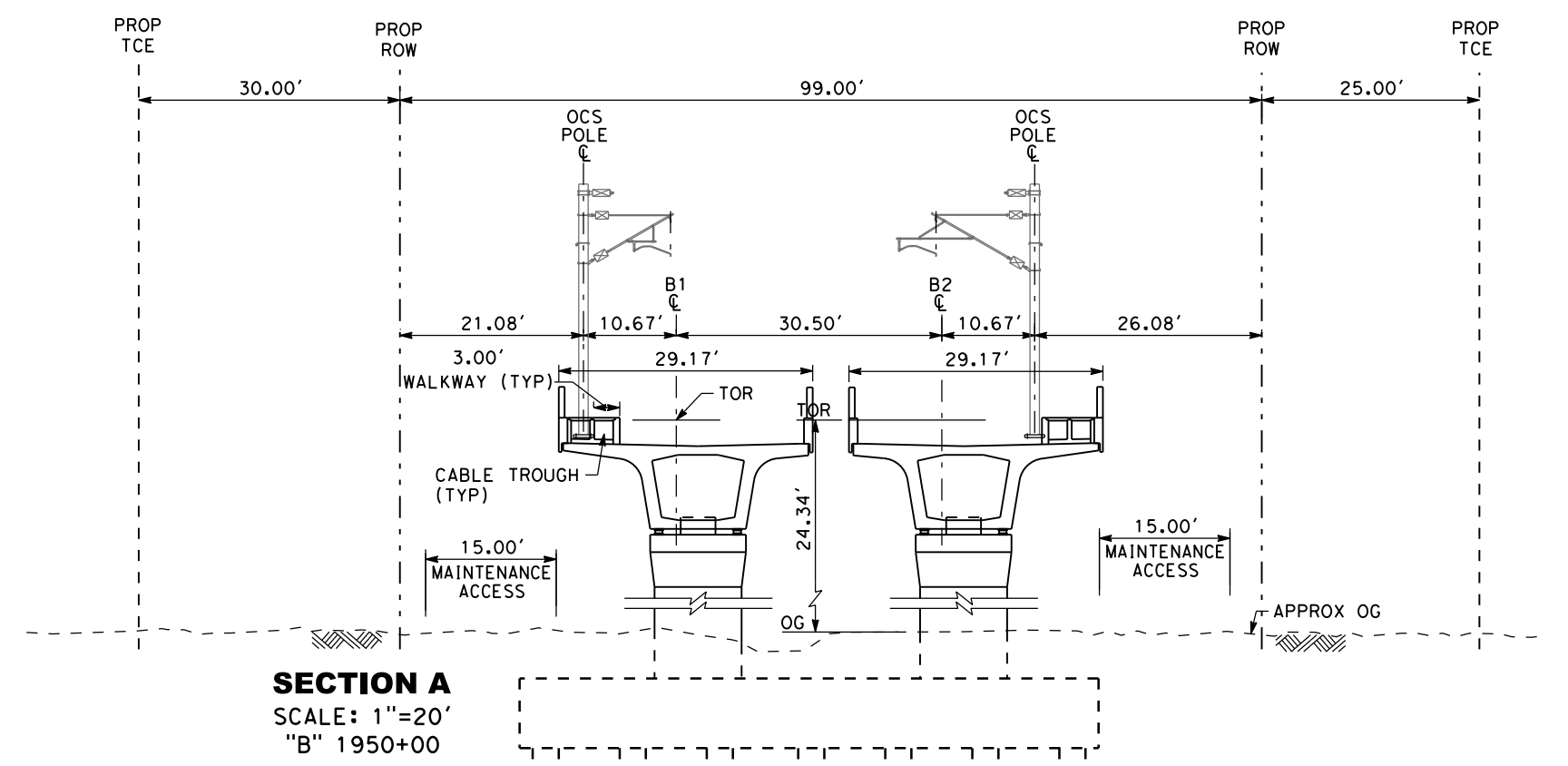

SECTION A SCALE: 1"=20' "B" 1950+00

- NOTES:**
- REFER TO GENERAL NOTES SHEETS GE-B0001 AND GE-B0002 FOR NOTES.
 - FOR STRUCTURAL TYPICAL SECTION SHEET ST-Y0001, SEE BOOK 1 OF 3 "ALTERNATIVE 1 - VIADUCT TO DOWNTOWN GILROY."
 - HSR ROW PROPOSED TO BE WIDENED BETWEEN HSR SB STATION 1890+00 TO STATION 2052+00 TO ACCOMMODATE FAULT RUPTURE CONDITIONS AT CALAVERAS FAULT. THE GROUND WEST OF CALAVERAS FAULT IS ASSUMED TO SHIFT 5' NORTH ALONG THE FAULT. WIDENED TRACK SECTION TO VARY BETWEEN 0' TO 5'.

SAN JOSE TO CVY EIR/S: VOLUME III
ALTERNATIVE 3
BOOK 3A
SHEET 25 OF 216

RECORD PERM SUBMITTAL MAY 3, 2019 NOT FOR CONSTRUCTION	HNTB 1111 Broadway 9th Floor Oakland, CA 94607	CALIFORNIA High-Speed Rail Authority	CALIFORNIA HIGH-SPEED TRAIN PROJECT SAN JOSE TO MERCED VIADUCT TO EAST GILROY COMPOSITE PLAN, PROFILE AND CROSS SECTIONS B1859+00 TO B1957+00	CONTRACT NO. HSR15-34 DRAWING NO. TT-D1301 SCALE: AS SHOWN SHEET NO.
--	--	--	--	---

SAN BENITO COUNTY

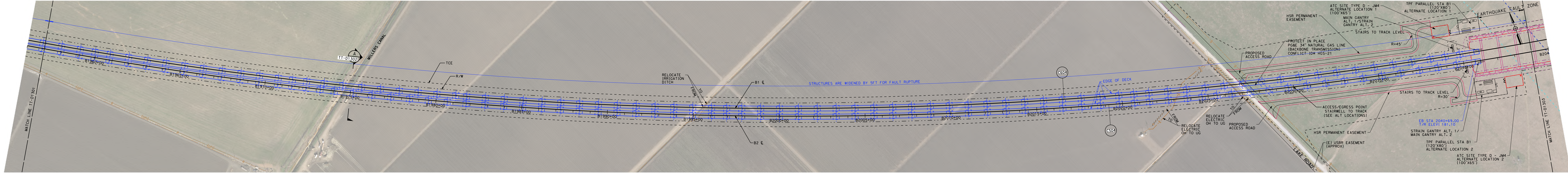

PLAN
SCALE: 1"=200'
1"=200' HOR

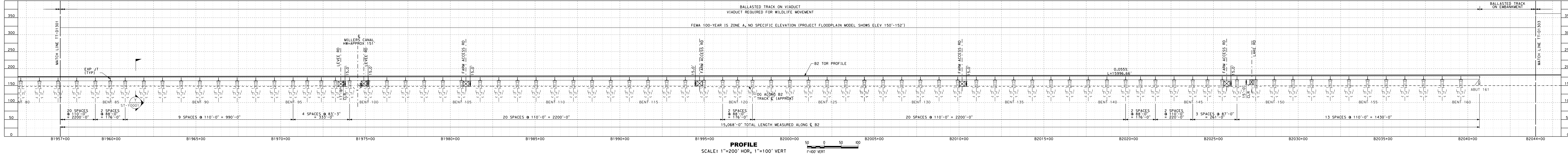

PROFILE
SCALE: 1"=200' HOR, 1"=100' VERT
1"=100' VERT

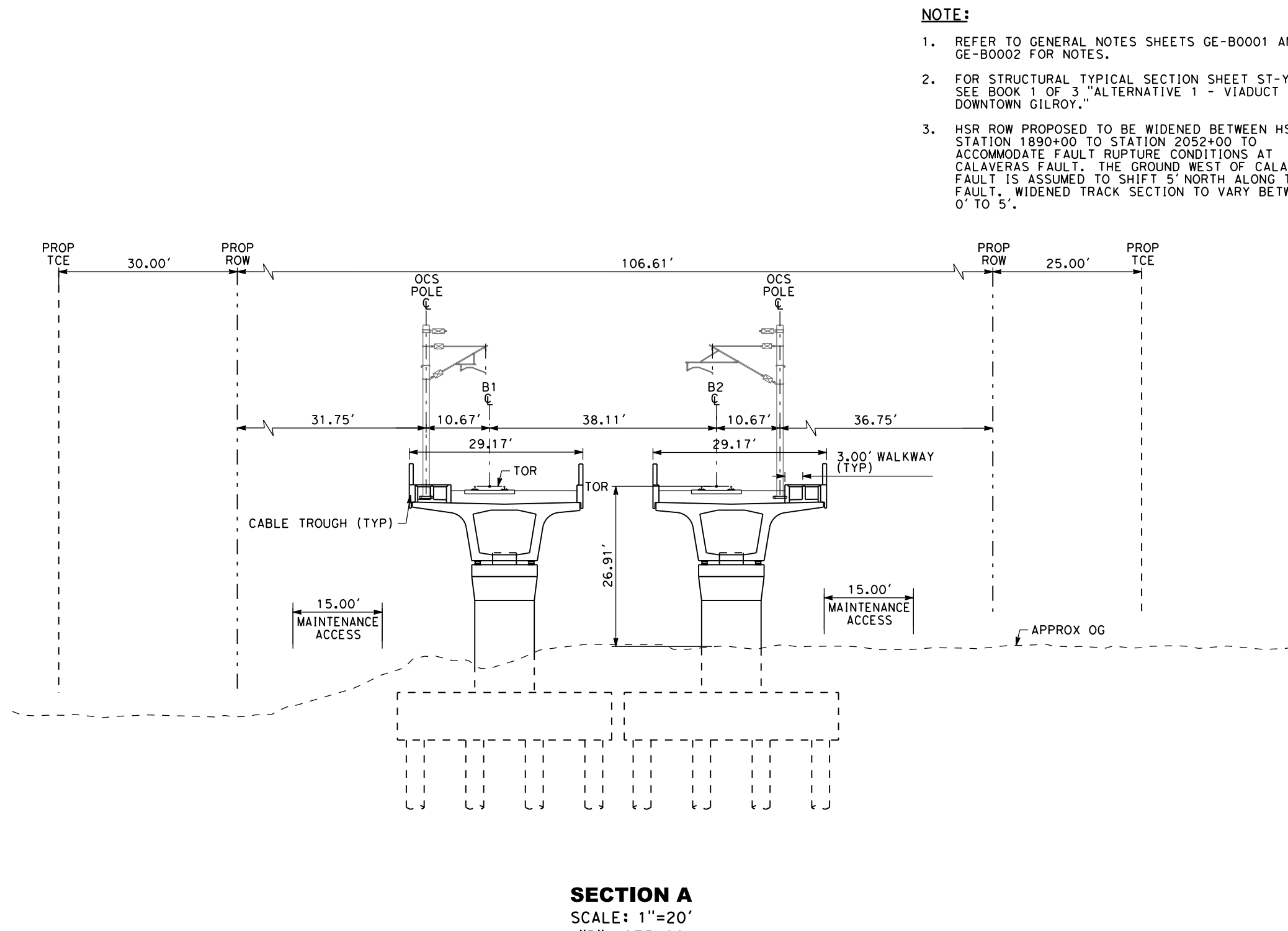

SECTION A
SCALE: 1"=20'
"B" 1975+00

- NOTE:**
- REFER TO GENERAL NOTES SHEETS GE-B0001 AND GE-B0002 FOR NOTES.
 - FOR STRUCTURAL TYPICAL SECTION SHEET ST-Y0001, SEE BOOK 1 OF 3 "ALTERNATIVE 1 - VIADUCT TO DOWNTOWN GILROY."
 - HSR ROW PROPOSED TO BE WIDENED BETWEEN HSR SB STATION 1990+00 TO STATION 2052+00 TO ACCOMMODATE FAULT RUPTURE CONDITIONS AT CALAVERAS FAULT. THE GROUND WEST OF CALAVERAS FAULT IS ASSUMED TO SHIFT 5' NORTH ALONG THE FAULT. WIDENED TRACK SECTION TO VARY BETWEEN 0' TO 5'.

SAN JOSE TO CVY EIR/S: VOLUME III
ALTERNATIVE 3
BOOK 3A
SHEET 26 OF 216

<p>RECORD PERM SUBMITTAL MAY 3, 2019 NOT FOR CONSTRUCTION</p>	<p>HNTB 1111 Broadway 9th Floor Oakland, CA 94607</p>	<p>CALIFORNIA High-Speed Rail Authority</p>	<p>CALIFORNIA HIGH-SPEED TRAIN PROJECT SAN JOSE TO MERCED MORGAN HILL AND GILROY VIADUCT TO EAST GILROY COMPOSITE PLAN, PROFILE AND CROSS SECTIONS B1957+00 TO B2044+00</p>	<p>CONTRACT NO. HSR15-34 DRAWING NO. TT-D1302 SCALE: AS SHOWN SHEET NO.</p>
---	--	--	---	---

SAN BENITO COUNTY

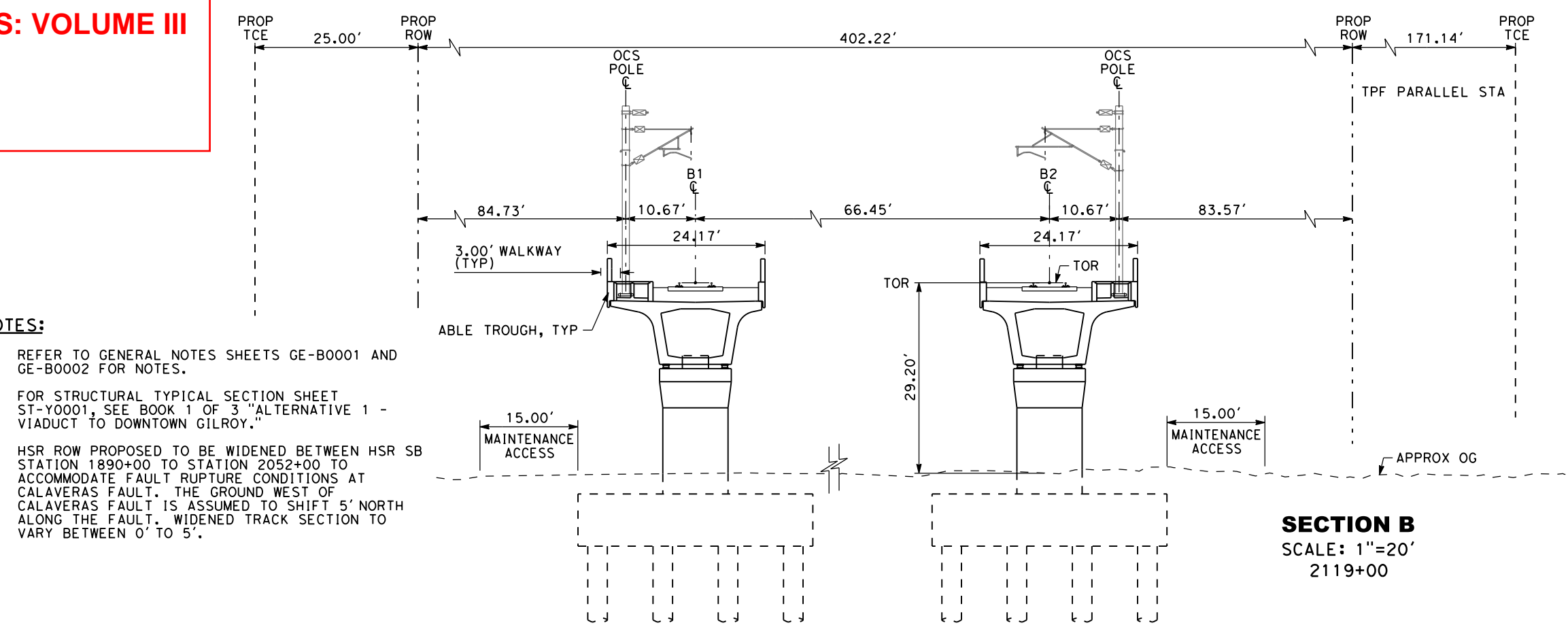
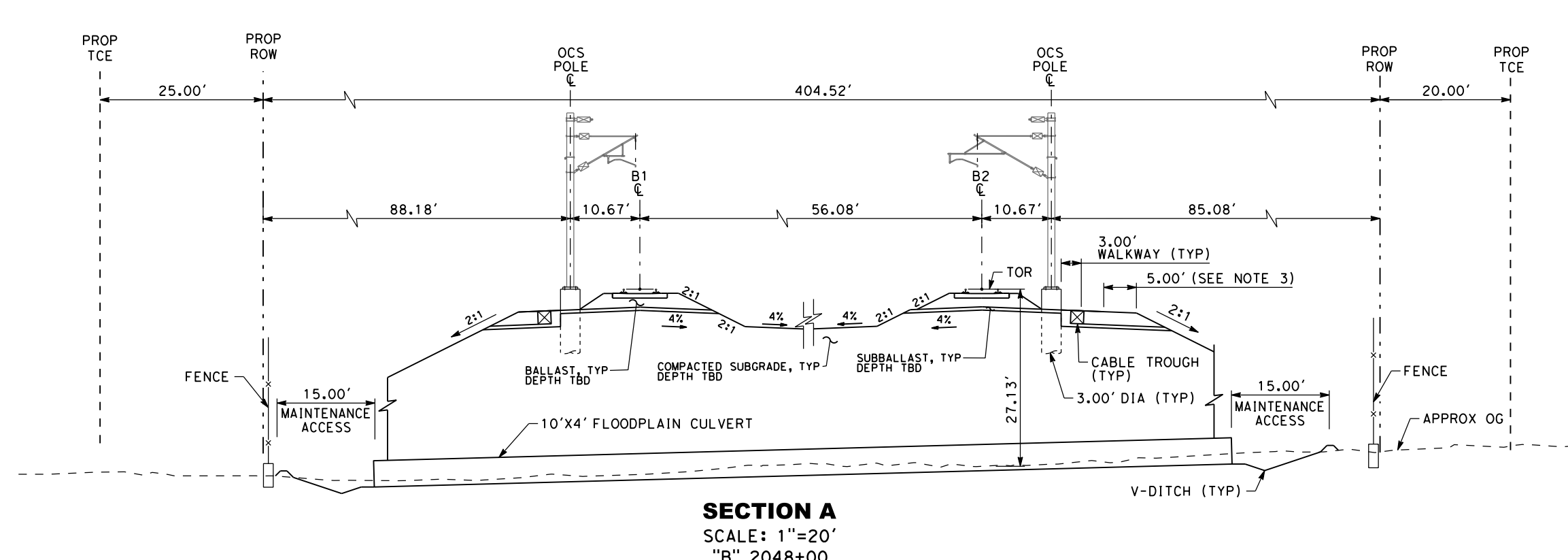
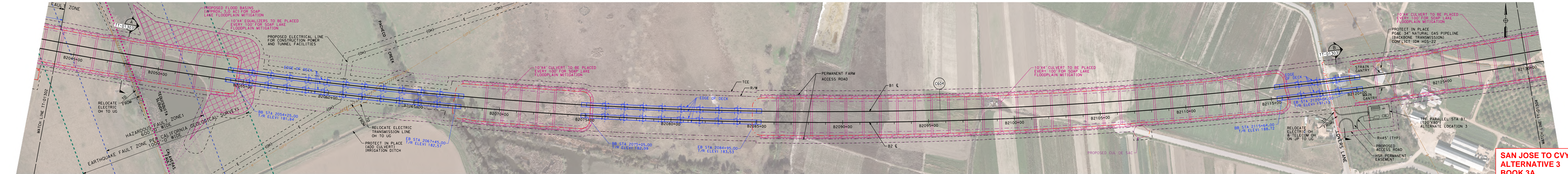

**SAN JOSE TO CVY EIR/S: VOLUME III
ALTERNATIVE 3
BOOK 3A
SHEET 27 OF 216**

- NOTES:**
- REFER TO GENERAL NOTES SHEETS GE-B0001 AND GE-B0002 FOR NOTES.
 - FOR STRUCTURAL TYPICAL SECTION SHEET ST-Y0001, SEE BOOK 1 OF 3 ALTERNATIVE 1 - VIADUCT TO DOWNTOWN GILROY.
 - HSR ROW PROPOSED TO BE WIDENED BETWEEN HSR SB STATION 1890+00 TO STATION 2082+00 TO ACCOMMODATE FAULT RUPTURE CONDITIONS AT CALAVERAS FAULT. THE GROUND WEST OF CALAVERAS FAULT IS ASSUMED TO SHIFT 5' NORTH ALONG THE FAULT. WIDENED TRACK SECTION TO VARY BETWEEN 0' TO 5'.

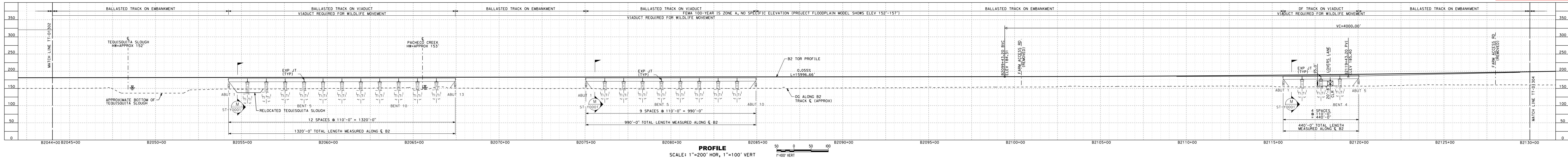

<p>RECORD PERM SUBMITTAL MAY 3, 2019 NOT FOR CONSTRUCTION</p>	<p>HNTB 1111 Broadway 9th Floor Oakland, CA 94607</p>	<p>CALIFORNIA High-Speed Rail Authority</p>	<p>CALIFORNIA HIGH-SPEED TRAIN PROJECT SAN JOSE TO MERCED MORGAN HILL AND GILROY VIADUCT TO EAST GILROY COMPOSITE PLAN, PROFILE AND CROSS SECTIONS B2044+00 TO B2130+00</p>	<p>CONTRACT NO. HSR15-34 DRAWING NO. TT-D1303 SCALE AS SHOWN SHEET NO.</p>
---	--	--	--	--

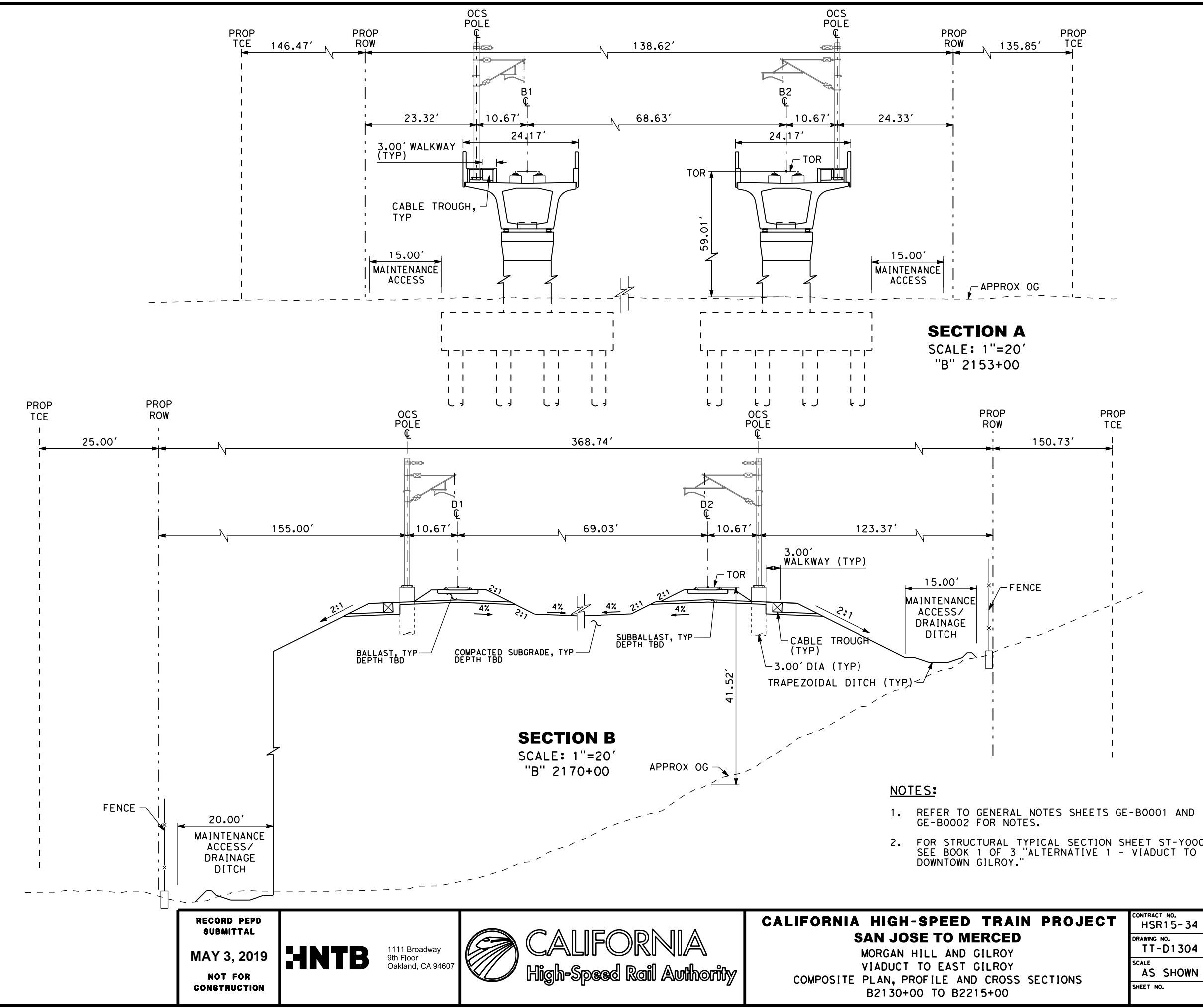
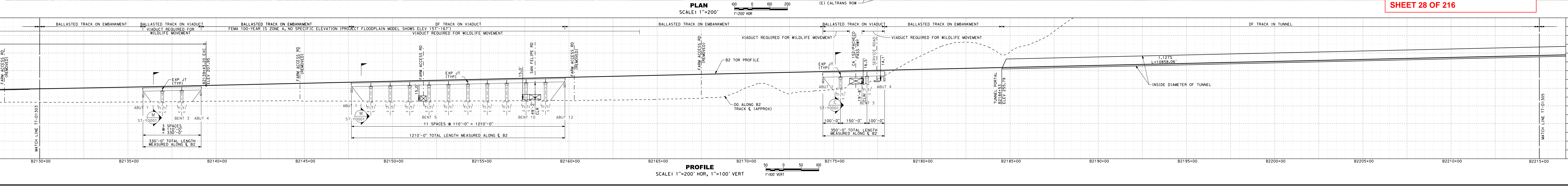
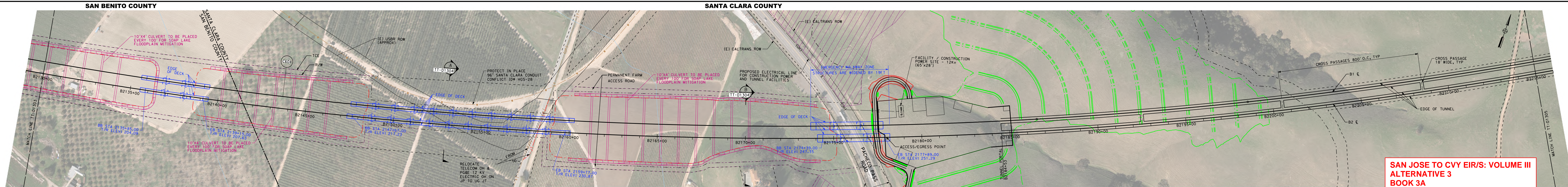

- NOTES:**
- REFER TO GENERAL NOTES SHEETS GE-B0001 AND GE-B0002 FOR NOTES.
 - FOR STRUCTURAL TYPICAL SECTION SHEET ST-Y0001, SEE BOOK 1 OF 3 ALTERNATIVE 1 - VIADUCT TO DOWNTOWN GILROY.

RECORD PERM SUBMITTAL MAY 3, 2019 NOT FOR CONSTRUCTION	HNTB 1111 Broadway 9th Floor Oakland, CA 94607	CALIFORNIA High-Speed Rail Authority	CALIFORNIA HIGH-SPEED TRAIN PROJECT SAN JOSE TO MERCED MORGAN HILL AND GILROY VIADUCT TO EAST GILROY COMPOSITE PLAN, PROFILE AND CROSS SECTIONS B2130+00 TO B2215+00	CONTRACT NO. HSR15-34 DRAWING NO. TT-D1304 SCALE AS SHOWN SHEET NO.
--	--	--	--	---



PLAN
SCALE: 1"=200'

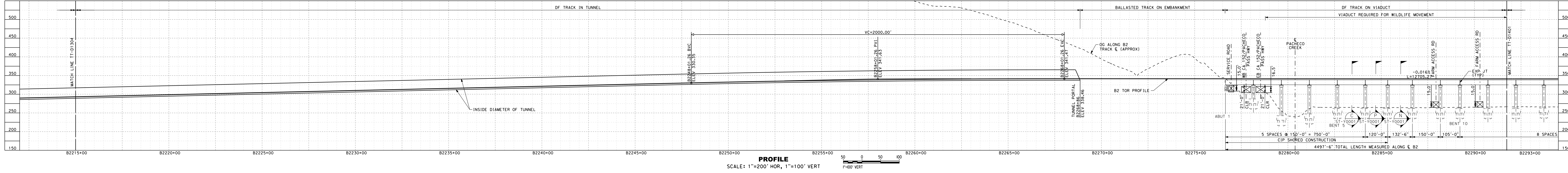
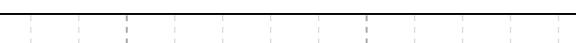

PROFILE
SCALE: 1"=200' HOR, 1"=100' VERT

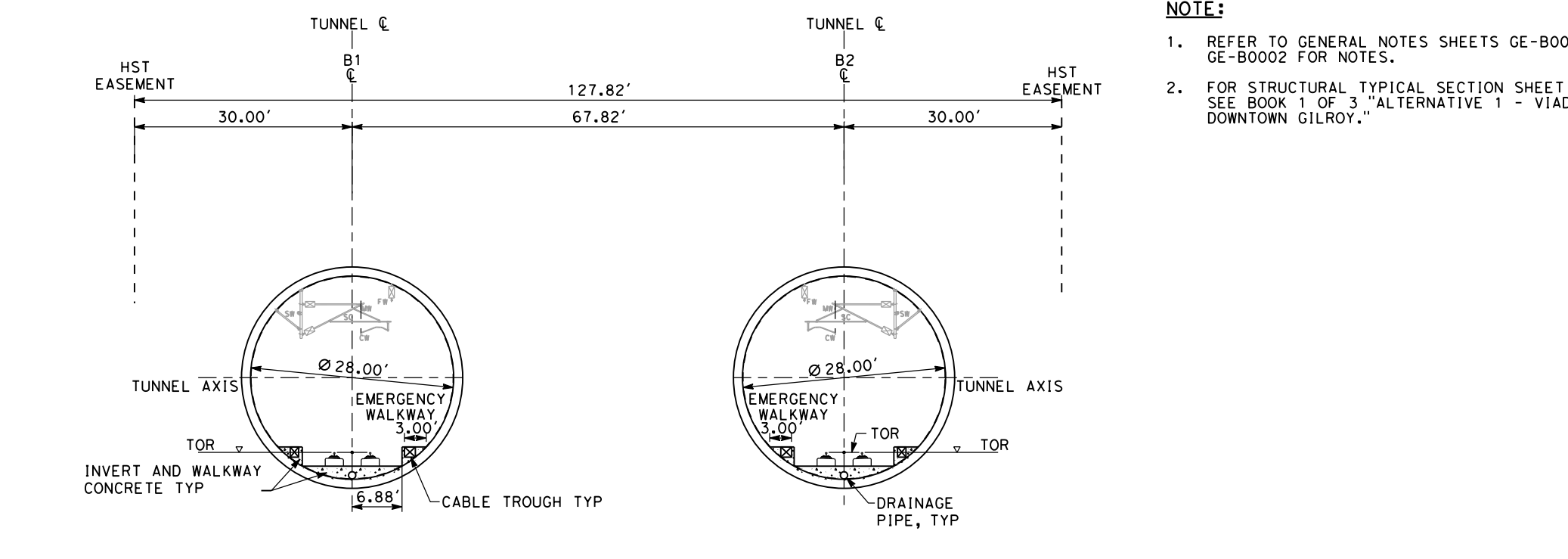

SECTION A
SCALE: 1"=20'
"B" 2230+00

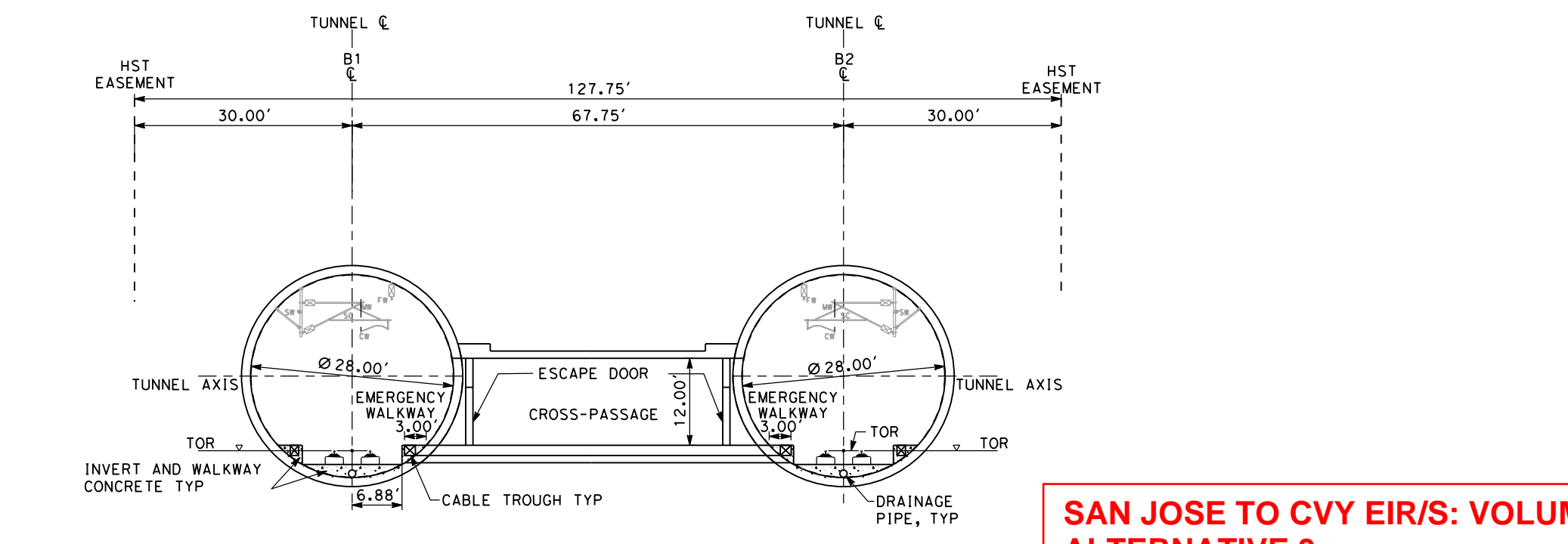

SECTION B
SCALE: 1"=20'
"B" 2232+53.47

- NOTE:**
- REFER TO GENERAL NOTES SHEETS GE-B0001 AND GE-B0002 FOR NOTES.
 - FOR STRUCTURAL TYPICAL SECTION SHEET ST-Y0001, SEE BOOK 1 OF 3 "ALTERNATIVE 1 - VIADUCT TO DOWNTOWN GILROY."

SAN JOSE TO CVY EIR/S: VOLUME III
ALTERNATIVE 3
BOOK 3A
SHEET 29 OF 216

<p>RECORD PERM SUBMITTAL MAY 3, 2019 NOT FOR CONSTRUCTION</p>	<p>HNTB 1111 Broadway 9th Floor Oakland, CA 94607</p>	<p>CALIFORNIA High-Speed Rail Authority</p>	<p>CALIFORNIA HIGH-SPEED TRAIN PROJECT SAN JOSE TO MERCED MORGAN HILL AND GILROY VIADUCT TO EAST GILROY COMPOSITE PLAN, PROFILE AND CROSS SECTIONS B2215+00 TO B2291+73.48 BK</p>	<p>CONTRACT NO. HSR15-34 DRAWING NO. TT-D1305 SCALE AS SHOWN SHEET NO.</p>
---	--	--	--	--