

## 2 ALTERNATIVES

### 2.1 Introduction

This chapter describes the two alternatives for the San Francisco to San Jose Project Section (Project Section, or project) and the No Project Alternative that the California High-Speed Rail Authority (Authority) is considering in this Draft Environmental Impact Report (EIR)/Environmental Impact Statement (EIS). The chapter addresses the following topics:

- The background and development of the California High-Speed Rail (HSR) System and the Project Section
- A general description of blended system and dedicated HSR system infrastructure
- Potential alternatives considered during the alternatives screening process and not carried forward for full evaluation in this Draft EIR/EIS
- The No Project Alternative and the project alternatives
- Travel demand and ridership forecasts
- Operations and service plan
- Construction plan
- Permits and approvals required

More detailed information on characteristics of the project is provided in the following appendices in Volume 2:

- Appendix 2-A, Roadway Crossings, Modifications, and Closures
- Appendix 2-B, Railroad Crossings
- Appendix 2-C, Operations and Service Plan Summary
- Appendix 2-D, Applicable Design Standards
- Appendix 2-E, Project Impact Avoidance and Minimization Features
- Appendix 2-F, Summary of Requirements for Operations and Maintenance Facilities
- Appendix 2-G, Emergency and Safety Plans
- Appendix 2-H, Constructability Assessment Report
- Appendix 2-I, Regional and Local Plans and Policies
- Appendix 2-J, Policy Consistency Analysis

The two project alternatives discussed in this chapter are consistent with and build from the train technology, alignment corridor, and station locations selected by the Authority and Federal Railroad Administration (FRA) at the conclusion of the Tier 1 EIR/EIS processes for the HSR system (see Section 1.1.2, The Decision to Develop a Statewide High-Speed Rail System). The alternatives are the result of the Authority’s consideration of an array of potential alternatives, with the benefit of public, stakeholder, and agency input. The design drawings that support the descriptions of the alternatives are provided in Volume 3, Preliminary Engineering Plans, of this Draft EIR/EIS. Figure 2-1 illustrates the alternatives considered in this Draft EIR/EIS. These alternatives are designed to a preliminary level of engineering sufficient to identify and analyze potential environmental impacts. Alternative A is the California Environmental Quality Act (CEQA) Proposed Project pursuant to CEQA Guidelines Section 15124 and the National Environmental Policy Act (NEPA) Preferred Alternative.



Sources: Authority 2019a, 2019b

NOVEMBER 2019

**Figure 2-1 Proposed San Francisco to San Jose Project Section**

The Project Section would provide HSR service between stations in San Francisco, Millbrae, and San Jose as part of Phase 1 of the HSR system. The Project Section includes approximately 43 to 49 miles of blended system infrastructure (depending on the alternative and viaduct option), with Caltrain and HSR service sharing tracks; 0 to 6 miles of dedicated HSR infrastructure (depending on the alternative and viaduct option); stations at 4th and King Street,<sup>1</sup> Millbrae, and San Jose Diridon; a light maintenance facility (LMF) in Brisbane; and an additional passing track option. Two project alternatives—Alternative A and Alternative B—are evaluated.

The project alternatives are divided into the following geographic subsections: San Francisco to South San Francisco, San Bruno to San Mateo, San Mateo to Palo Alto, Mountain View to Santa Clara, and San Jose Diridon Station Approach (Figure 2-1). The San Jose Diridon Station Approach Subsection was fully analyzed as part of the San Jose to Merced Project Section Draft EIR/EIS and corresponding technical reports. The analysis of this subsection has been incorporated into this Draft EIR/EIS to support a station-to-station analysis with logical termini for the San Francisco to San Jose Project Section. However, the decision on selection of alternatives between Scott Boulevard in Santa Clara and West Alma Avenue in San Jose would occur as part of the environmental approvals process for the San Jose to Merced Project Section.

This Draft EIR/EIS analyzes the environmental impacts—direct, indirect, and cumulative—of implementing the Project Section and mitigation measures to reduce significant impacts. Visit the Authority website ([www.hsr.ca.gov](http://www.hsr.ca.gov)) to view and download the Draft EIR/EIS. You may also request a copy of the Draft EIR/EIS by calling (800) 435-8670. Printed and/or electronic copies of the Draft EIR/EIS and electronic copies of associated technical reports will be available at the following libraries, during hours the facilities are open: San Francisco, Brisbane, South San Francisco, San Bruno, Millbrae, Burlingame, San Mateo, Belmont, San Carlos, Redwood City, Atherton, Menlo Park, Palo Alto, Mountain View, Sunnyvale, Santa Clara, and San Jose. Printed and/or electronic copies of the Draft EIR/EIS and electronic copies of associated technical reports are also available for review during business hours at the Authority’s Northern California Regional Office at 100 Paseo de San Antonio, Suite 300, San Jose, CA 95113 and the Authority’s Headquarters at 770 L Street, Suite 620 MS-1, Sacramento, CA 95814. The following documents are also available on request via the Authority’s website ([www.hsr.ca.gov](http://www.hsr.ca.gov)) or by calling (800) 435-8670: alternative analyses preceding preparation of the Draft EIR/EIS, materials prepared for coordination with the U.S. Army Corps of Engineers (USACE) and U.S. Environmental Protection Agency (USEPA) in compliance with Clean Water Act (CWA) Section 404(b)(1) requirements, and technical reports developed for the environmental analyses presented in Chapter 3, Affected Environment, Environmental Consequences, and Mitigation Measures.

### *San Francisco to San Jose Project Section Subsections*

- **San Francisco to South San Francisco**—10 miles from 4th and King Street Station in San Francisco to Linden Avenue in South San Francisco
- **San Bruno to San Mateo**—8 miles from Linden Avenue in South San Francisco to Ninth Avenue in San Mateo
- **San Mateo to Palo Alto**—16 miles from Ninth Avenue in San Mateo to San Antonio Road in Palo Alto
- **Mountain View to Santa Clara**—9 miles from San Antonio Road in Palo Alto to Scott Boulevard in Santa Clara
- **San Jose Diridon Station Approach**—6 miles from Scott Boulevard in Santa Clara to West Alma Avenue in San Jose

<sup>1</sup> The 4th and King Street Station would serve as an interim HSR station until completion of the proposed Downtown Extension Project (DTX). The DTX would extend the electrified peninsula rail corridor in San Francisco from the 4th and King Street Station to the Salesforce Transit Center (SFTC). HSR would utilize the track built for the DTX to reach the SFTC. The DTX and SFTC projects were environmentally cleared in the *Transbay Terminal/Caltrain Downtown Extension/Redevelopment Project Final Environmental Impact Statement/Environmental Impact Report* (USDOT et al. 2004). Caltrain intends to use the new underground 4th and Townsend Street Station as well as continue to use the existing 4th and King Street Station once the DTX is completed.

Portions of the Project Section with blended Caltrain and HSR operations would be implemented on facilities owned by the Peninsula Corridor Joint Powers Board (PCJPB).<sup>2</sup> While the alternative descriptions have been developed based on planning assumptions and preliminary engineering conducted by the Authority for the purposes of environmental analysis, the ultimate implementation of the project (both physical infrastructure and service operations) on PCJPB-owned facilities would be subject to further joint blended system planning and agreement with PCJPB as governed through existing and future interagency agreements. The ongoing multi-agency Diridon Integrated Station Concept planning process is a separate planning process and decisions about future changes to the San Jose Diridon Station and the surrounding, PCJPB-owned rail infrastructure and corridor are the subject of multiple planning and agreement processes that are proceeding independently from this environmental process.

## 2.2 Independent Utility

As discussed in Chapter 1, Project Purpose, Need, and Objectives, the Authority and FRA divided the HSR system originally established with Tier 1 decisions into individual project sections for Tier 2 planning, environmental review, and decision making (see Figure 1-2). The FRA considers three criteria when determining the scope of a project to be considered in an EIS: (1) whether it connects “logical termini” and has “sufficient length to address environmental matters on a broad scope”; (2) whether it has “independent utility or independent significance,” meaning it would “be usable and be a reasonable expenditure even if no additional transportation improvements in the area are made”; and (3) whether it would “restrict consideration of alternatives for other reasonably foreseeable transportation improvements” (23 Code of Federal Regulations [C.F.R.] § 771.111(f)).<sup>3</sup> The Federal Highway Administration (FHWA) defines *logical termini* as the rational starting and ending points for a transportation improvement project and for review of the environmental impacts of the project (FHWA 1993).<sup>4</sup> The Project Section connects logical termini at planned passenger stations in San Francisco and San Jose where HSR service could be provided. If other project sections of the HSR system are not completed, the infrastructure could be used by regional and intercity services to improve their capacity, reliability, and performance (Leavitt 2009).

## 2.3 Background

This Project Section would be a critical link in the Phase 1 HSR system connecting the San Francisco Bay Area (Bay Area) to Los Angeles and Anaheim. The Authority relied on program EIR/EIS documents (see Section 1.1.2) to select the alternatives for further study between the Bay Area and the Central Valley. The project-level environmental review process and alternatives considered in this document are consistent with the decisions made during the Tier 1 review process and are discussed further in Section 2.5, Alternatives Considered during Alternatives Screening Process.

---

<sup>2</sup> PCJPB is the owner and managing authority for the Peninsula Corridor.

<sup>3</sup> While these regulations do not apply to this project because it was initiated prior to November 28, 2018 (the effective date of the regulations (23 C.F.R. § 771.109(a)(4)), these criteria were used to determine the scope of the Project Section.

<sup>4</sup> The criteria for determining project scope, as established in 23 C.F.R. Section 771.111(f), do not specifically address the scope of individual projects considered in the second tier of a tiered NEPA process. With the tiered NEPA process, the same general principles apply, but they are applied in the context of the decisions made in Tier 1—in this case, the decision to build the HSR system as a whole. Therefore, in determining the scope of individual project sections for Tier 2 studies, the Authority and FRA focused primarily on determining whether each project section could serve a useful transportation purpose on its own such that a decision in one project section does not limit consideration of reasonable alternatives for completing the HSR system in an adjacent project section for which the NEPA process has not yet been completed.

## 2.4 High-Speed Rail System Infrastructure

General information about the performance criteria, infrastructure components and systems, and function of the Project Section, which is predominantly a blended system, is provided in Section 2.4.1, System Design Performance, Safety and Security, through Section 2.4.8, Maintenance Facilities. The limited amount of dedicated HSR infrastructure, which would be part of the project under Alternative B, is described in Section 2.4.9, Dedicated High-Speed Rail Infrastructure. Detailed information on the project alternatives, including modifications to the existing rail system and stations, an LMF, signaling and train-control elements, and safety and security modifications, is provided in Section 2.6, Alignments, Station Sites, and Maintenance Facilities Evaluated in this Draft EIR/EIS.

---

### *What does “blended” mean?*

*Blended* refers to operating the HSR trains with existing intercity and commuter and regional rail trains on common infrastructure (blended operations).

---

The project’s alignment, design options, and operational facilities, such as the LMF, are presented in this Draft EIR/EIS geographically from 4th and King Street Station in San Francisco to West Alma Avenue south of the San Jose Diridon Station in San Jose. The Preliminary Engineering Plans design drawings—showing track alignments, vertical profiles, typical sections, construction use areas, and other preliminary design information—are provided in Volume 3 of this Draft EIR/EIS, which is available on the Authority’s website ([www.hsr.ca.gov](http://www.hsr.ca.gov)). You may also request a copy of the Draft EIR/EIS, which includes Volume 3, by calling (800) 435-8670. Printed and/or electronic copies of Volume 3 are also available for review, at the repository locations, the Authority’s Northern California Regional Office at 100 Paseo de San Antonio, Suite 300, San Jose, CA 95113, and the Authority’s Headquarters at 770 L Street, Suite 620 MS-1, Sacramento, CA 95814, during hours the facilities are open.

The project would operate on a predominantly two-track system primarily within the existing Caltrain right-of-way, utilizing existing and in-progress infrastructure improvements developed by Caltrain for its Caltrain Modernization Program, including electrification of the Caltrain corridor between San Francisco and San Jose as part of the Peninsula Corridor Electrification Project (PCEP). Operation of the blended system would require additional infrastructure improvements and project elements beyond the Caltrain Modernization Program to accommodate HSR service, which are described in detail in Section 2.6.2, High-Speed Rail Alternatives for the San Francisco to San Jose Project Section.

In the blended portions of the system, HSR and Caltrain would operate at speeds of up to 110 miles per hour (mph) and would have a coordinated schedule to allow both services to efficiently serve their respective stations. HSR trains would be able to pass Caltrain trains in existing four-track segments, at the Millbrae Station under both project alternatives, and along a new passing track under Alternative B.

Limited freight service (approximately three round trips per day) operates between San Francisco and San Jose using the same tracks as Caltrain; this service would continue to operate with PCEP and with HSR using the same tracks as Caltrain and HSR.

The blended system includes HSR trains, station and platform modifications to accommodate HSR trains passing through or stopping at existing stations; track modifications to support higher speeds while maintaining passenger comfort; modifications to the overhead contact system (OCS) (a series of wires strung above the tracks on poles); and potential equipment upgrades at traction power facilities (TPF) installed by Caltrain as part of the PCEP. The project would implement safety improvements at existing at-grade roadway crossings and Caltrain stations and platforms, as well as security modifications such as installing perimeter fencing along the right-of-way. The project would also build an LMF to accommodate planned operational needs for high-capacity rail movement and install communication radio towers at approximately 2.5-mile intervals. Additional passing tracks would be provided under Alternative B.

### 2.4.1 System Design Performance, Safety, and Security

The blended system has been designed as a partially grade-separated, limited access guideway for optimal performance in conformance with industry standards and federal and state safety regulations (Table 2-1). Speeds in the blended portions of the alternatives would be up to 110 mph. At-grade roadway crossings would be controlled by four-quadrant gates and roadway channelization. Continuous fencing would deter access to the right-of-way outside of station platforms and at-grade roadway crossings.

**Table 2-1 Blended System Rail Performance Criteria**

Category	Criteria
System design criteria	<ul style="list-style-type: none"> <li>▪ Electric propulsion system</li> <li>▪ Partially grade-separated guideway</li> <li>▪ Limited-access guideway</li> <li>▪ Track geometry to maintain passenger comfort criteria</li> </ul>
System capabilities	<ul style="list-style-type: none"> <li>▪ Designed to achieve maximum nonstop service times of 30 minutes between San Francisco and San Jose</li> <li>▪ All-weather/all-season operation</li> <li>▪ Capable of sustained vertical gradient of 2.5% without considerable degradation in performance</li> <li>▪ Capable of operating parcel and special freight service as a secondary use</li> <li>▪ Capable of safe, comfortable, and efficient operation at speeds of up to 110 miles per hour</li> <li>▪ Capable of maintaining operations at 3-minute headways</li> <li>▪ Equipped with high-capacity and redundant communications systems capable of supporting fully automatic train control</li> </ul>
System capacity	<ul style="list-style-type: none"> <li>▪ Mixed track configuration</li> <li>▪ Capable of accommodating a wide range of passenger demand (up to 20,000 passengers per hour per direction)</li> <li>▪ Capable of accommodating normal maintenance activities without disruption to daily operations</li> </ul>
Level of service	<ul style="list-style-type: none"> <li>▪ Capable of accommodating a range of service types (express, semi-express/limited stop, and local)</li> </ul>

The ends of the HSR trainsets (train cars) would include a collision response management system to minimize the impacts of a collision. All aspects of the HSR system would conform to the latest federal requirements regarding transportation security. The HSR trainsets would be pressure-sealed to maintain passenger comfort regardless of aerodynamic change, much like an airplane body. Additional information regarding system safety and security is provided in Section 3.11, Safety and Security.

HSR operations would follow safety and security plans developed by the Authority in cooperation with FRA that include the following:

- A safety and security management plan (Authority 2016a), including a safety and security certification program, has been developed to address safety, security, and emergency response as they relate to the day-to-day operation of the system.
- A threat and vulnerability assessment for security, a preliminary hazard analysis, and a vehicle hazard analysis produced comprehensive design criteria for safety and security requirements mandated by local, state, and federal regulations and industry best practices.
- A fire and life safety and security program (Authority 2012a) has been developed, and a system security plan is in development. Under federal and state guidelines and criteria, the fire and life safety plan would address the safety of passengers and employees as it relates to emergency

response. The system security plan would address HSR design features intended to maintain security at stations, within the trackwork right-of-way, and onboard trains.

Design criteria address FRA safety standards and requirements as well as a possible Petition for Rule of Particular Applicability that addresses specifications for key design elements for the system. The FRA is currently developing safety requirements for HSR systems for use in the United States. The FRA would require that the HSR safety regulations be met prior to revenue service operations.

### 2.4.2 Vehicles

Although the exact vehicle type has not yet been selected, the environmental analyses considered the impacts associated with HSR vehicles produced in the world that meet the Authority's safety and operational criteria. All HSR systems in operation today use electric propulsion with power supplied by an OCS. These systems include, among many others, the Train à Grande Vitesse in France, the Shinkansen in Japan and Taiwan, and the InterCity Express in Germany. Figure 2-2 and Figure 2-3 illustrate examples of typical HSR trains.



Source: Authority and FRA 2017a

**Figure 2-2 Example of an At-Grade Profile Showing Overhead Contact System and Vertical Arms of the Pantograph Power Pickups**



Source: Authority and FRA 2017a

**Figure 2-3 Examples of Japanese Shinkansen High-Speed Trains**

The Authority is considering an electric multiple unit (EMU) concept, in which several train cars (including both end cars) would contain traction motors, rather than a locomotive-hauled train (i.e., one engine in the front and one in the rear). Each train car would have an active suspension, and each powered car would have an independent regenerative braking system (which returns power to the power system). The body would be made of strong but lightweight materials and would have an aerodynamic shape to minimize air resistance, much like a curved airplane body.

A typical train would be 9 to 11 feet wide, consisting of two approximately 660-foot-long trainsets (each comprised of eight cars). A train with two trainsets (i.e., 16 cars) would seat up to 1,000 passengers. Power would be distributed to each train car via the OCS through a pair of pantographs extending like antennae above the train (Figure 2-2). Each trainset would have a train control system that could be independently monitored with override control, while also communicating with the systemwide operations control center. Phase 1 HSR service is expected to need up to 78 trainsets in 2040, depending on the HSR fares charged and ridership levels (Authority and FRA 2017a).

### 2.4.3 Stations

Stations would be sized for projected HSR ridership and designed to provide flexibility to accommodate future growth. Station facilities would include public and nonpublic areas, station site improvements to facilitate intermodal connectivity and station accessibility, and ancillary facilities. For existing stations modified for HSR service, public areas and station site improvements would be shared with other rail operators serving the station.

Station design is developed at a conceptual level—Preliminary Engineering for Project Definition—for project-level environmental analysis and documentation, sufficient for disclosing the environmental impacts of building and operating a station. Figure 2-4 illustrates an example of station components from an existing overseas system and the Anaheim Regional Transportation Center.<sup>5</sup> The functional station is a basic design that could be more elaborate with cooperation from the local jurisdiction; accordingly, each actual station has the potential to be an iconic building that would enhance the identity of the city and the surrounding downtown environment in which it is located. Final station design would involve Authority collaboration with rail operators, local stakeholders, and land partners to complement transit-oriented and other station-supportive development.



Source: Volume 2, Appendix 2-H

**Figure 2-4 Examples of Existing Stations**

<sup>5</sup> The Anaheim Regional Transportation Center would serve as the HSR station in Anaheim.



Preliminary station planning and design are based on Chapter 14, Stations, of the *Design Criteria Manual* (Authority 2016b) and principles from the Authority’s *HST Station Area Development: General Principles and Guidelines* (Authority 2011a). Stations would be designed in accordance with Americans with Disabilities Act accessibility guidelines. The project would modify three existing stations as part of the blended system, rather than build new stations. HSR trains would stop at the 4th and King Street Station in San Francisco (which would serve as an interim station until completion of the Downtown Extension Project [DTX]), the Millbrae Bay Area Rapid Transit (BART)/Caltrain intermodal station, and the San Jose Diridon Station, requiring the reconfiguration of platforms and the accommodation of passenger services at these stations, as described in detail in Section 2.6.2.

**2.4.3.1 Station Platforms and Trackway (Station Box)**

Stations would provide a sheltered area and platforms for passenger waiting as well as circulation elements (e.g., stairs, elevators, escalators). In the Project Section, station platforms and trackways vary among the 4th and King Street Station, Millbrae Station, and San Jose Diridon Station (see specific descriptions later in this chapter). Figure 2-5 and Figure 2-6 illustrate cross sections of two- and four-train station platforms. The two-train station platform illustration is representative of the platform configuration that would occur under Alternative B at the existing Hayward Park, Belmont, and San Carlos Stations, while the four-train station platform illustration is representative of the platform configuration that would occur under Alternative B at the existing Hillsdale Station.

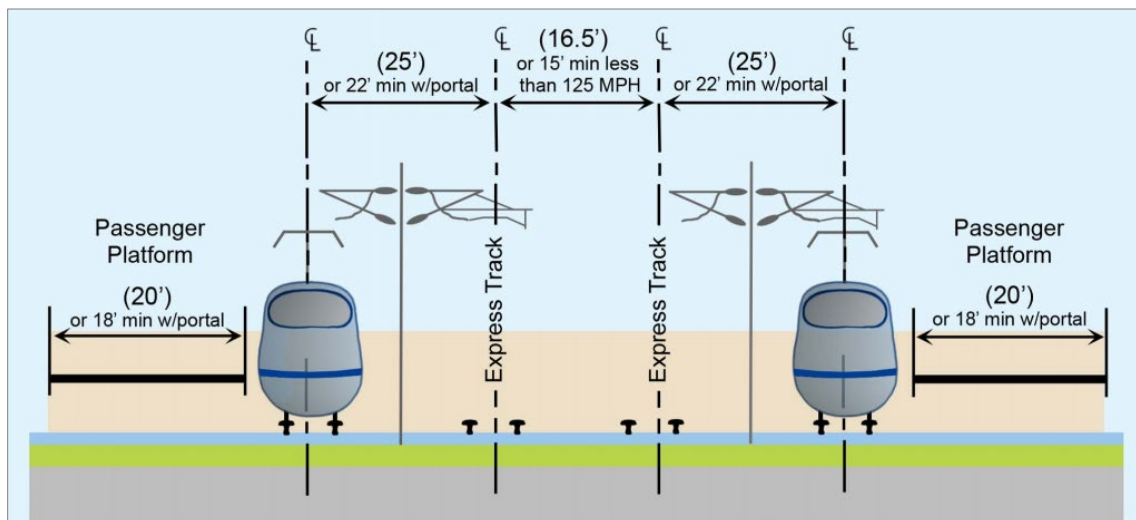

Source: Authority 2010

**Figure 2-5 Two-Train Station Platform Cross Section**

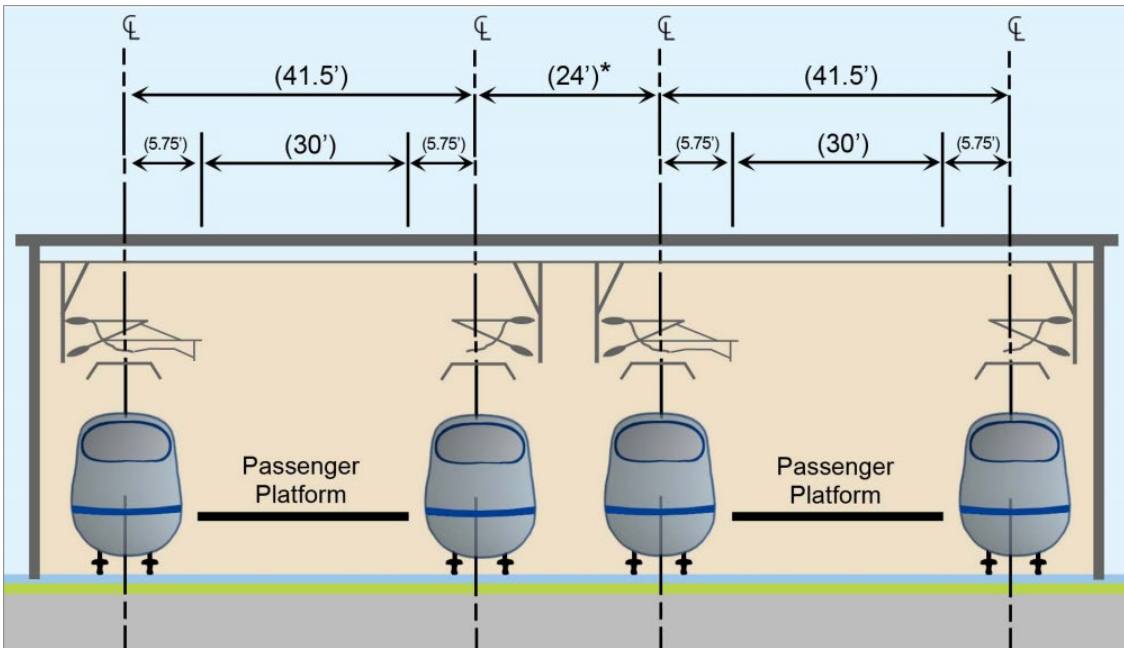

Source: Authority 2010

**Figure 2-6 Four-Train Station Platform Cross Section**

### 2.4.3.2 Station Facilities Building

Station public areas typically include entry plazas and building entrances; ticketing; wayfinding/signage; publicly accessible restrooms; concessionaire-provided amenities such as food service, rental car counters, and retail; vertical circulation; concourse or mezzanine areas with passenger waiting areas; fare gates; controlled paid areas; and platforms. Pedestrian over-track bridges and under-track passageways enable public access across the rail right-of-way at stations. Nonpublic station areas include administrative, maintenance, operations, safety/security, loading, and back-of-house circulation areas.

Station site improvements provide safe and efficient access for pedestrians, bicycles, transit, and vehicles to and from the station. Pick-up and drop-off zones offer direct and convenient access for taxis, ride hailing/sharing services, shuttles, transit, and private and commercial vehicles. Parking supply estimates are based on projected parking demand and local conditions. Station site plans are configured to support transit-oriented development (TOD). Ancillary facilities are unoccupied back-of-house spaces required for station operations and maintenance (O&M), including normal, back-up, and emergency power systems.

### 2.4.4 Infrastructure Components

The blended system from 4th and King Street Station in San Francisco to West Alma Avenue in San Jose (Alternative A), to Interstate (I-) 880 (Alternative B [Viaduct to I-880]) or to Scott Boulevard in Santa Clara (Alternative B [Viaduct to Scott Boulevard]) would consist of predominantly two-track ballasted track of varying profiles. Low, near-the-ground tracks would be at grade, higher tracks would be elevated on embankment (earthen fill graded to a slope on either side or supported by retaining walls) and structure (viaduct), and below-grade tracks would extend through four existing short tunnels in San Francisco. The dedicated HSR system from I-880 (Alternative B [Viaduct to I-880]) or Scott Boulevard (Alternative B [Viaduct to Scott Boulevard]) to West Alma Avenue would be on viaduct. The following sections describe the various track profiles.

**2.4.4.1 At-Grade Profile**

Most of the Project Section blended system would be two-track at-grade profile, with a minimum of 15 feet between track centerlines (Figure 2-7). The at-grade railbed would consist of compacted soil and ballast materials (crushed rock) to prevent subsidence or changes in the track surface from soil movement. The height of the at-grade profile would vary to accommodate changes in topography and provide clearance for ditches and stormwater culverts to facilitate drainage. Existing four-track at-grade tracks occur in Brisbane, North Fair Oaks, and Lawrence. Additionally, under Alternative A, there would be a stretch of three-track at-grade alignment in San Jose where a new Union Pacific Railroad (UPRR) track would parallel the blended system track (Figure 2-8).

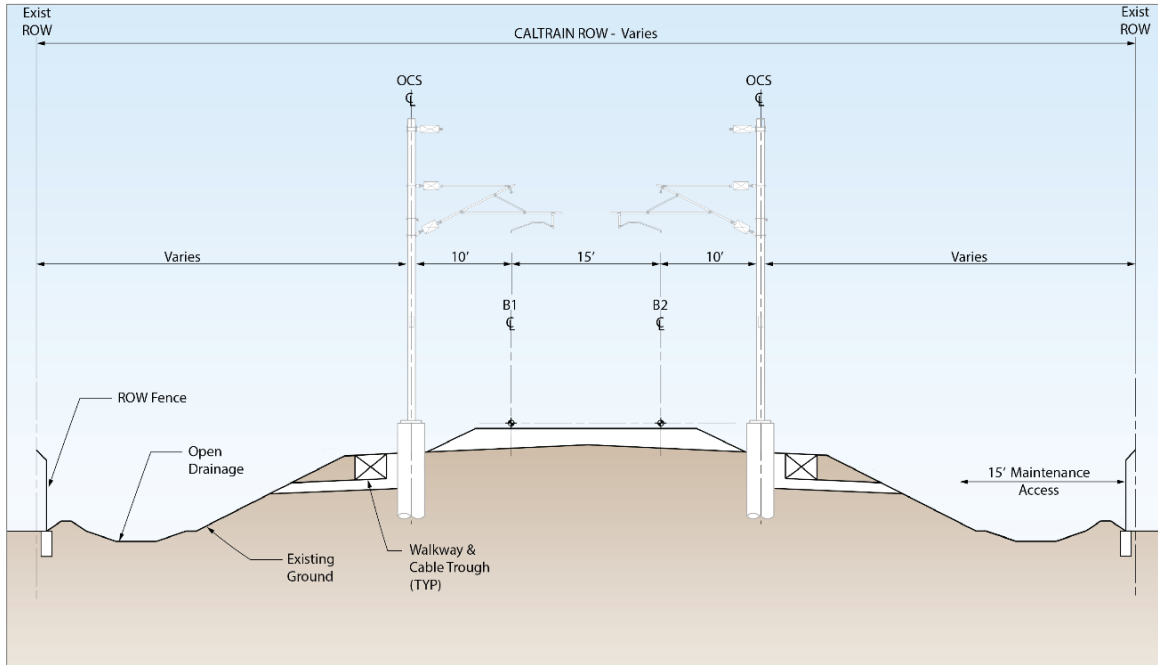

FEBRUARY 2017

**Figure 2-7 Typical At-Grade Cross Section for Blended System**

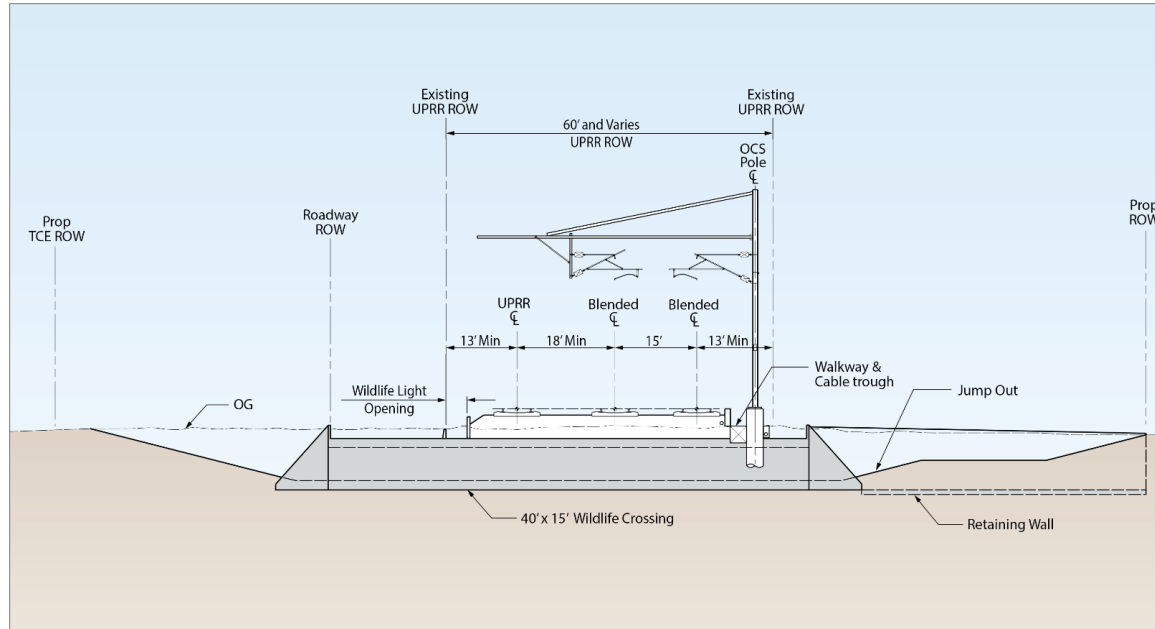

MARCH 2019

**Figure 2-8 Typical At-Grade Cross Section for Blended System in San Jose (Alternative A Only)**

#### 2.4.4.2 Embankment Profile

Portions of the blended system would be on embankment profile, where earthen fill exceeds 5 feet in height. Depending upon native ground stability and space available, embankment of earthen fill is built with or without fill-retaining structures. Retained-fill profiles (Figure 2-9) are used when it is necessary to narrow the right-of-way within a constrained corridor to minimize property acquisition or to accommodate roadway undercrossings. In locations with retained-fill profile, the guideway would be raised off the existing ground on compacted earthen fill supported by vertical walls that retain the fill within the guideway. Short retaining walls would protect adjacent properties from a slope extending beyond the rail guideway. Embankment profile would occur for the Brisbane lead tracks, for an approximately 0.7-mile portion of alignment in San Bruno south of I-380, at Hillcrest Boulevard in Millbrae, and an approximately 0.3-mile portion of alignment south of East Poplar Avenue in San Mateo for both alternatives. Embankment profile would also occur along most of the length of the passing track in San Mateo, Belmont, and San Carlos under Alternative B.

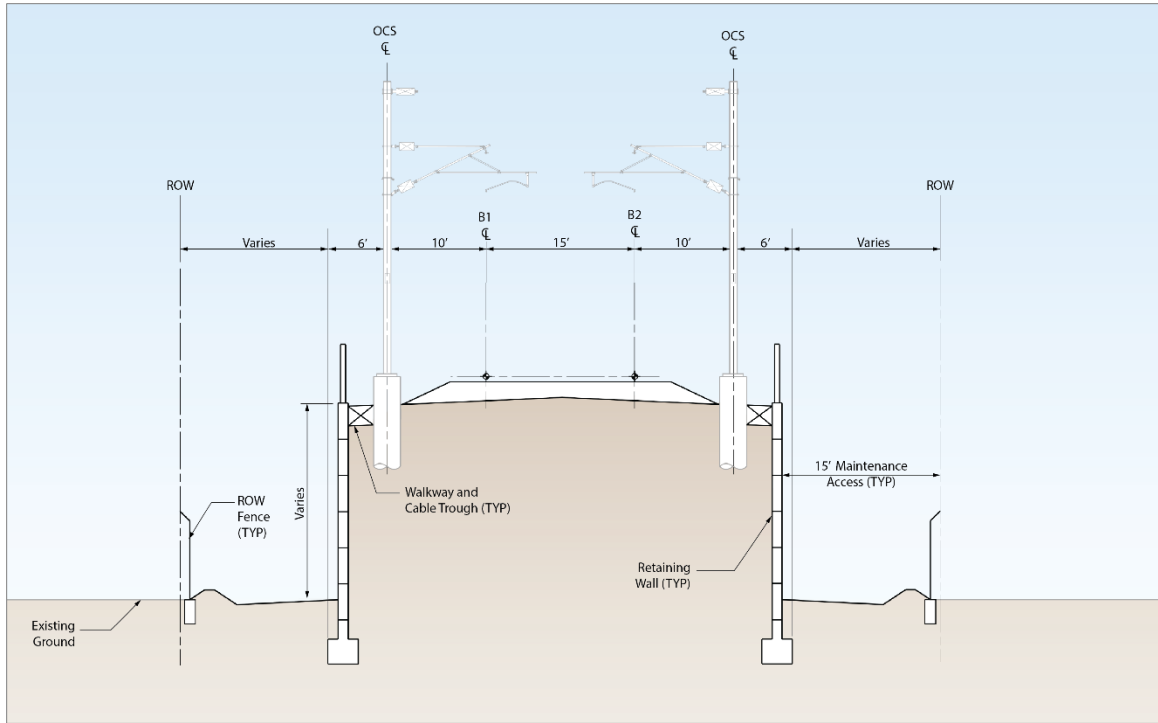

FEBRUARY 2017

**Figure 2-9 Typical Retained-Fill Cross Section**

**2.4.4.3 Tunnel Profile**

Tunnel profiles are used where the rail alignment traverses highly variable topography or highly constrained, densely developed urban situations. Tunnels reduce track distance and curvature needed to maintain acceptable vertical and horizontal grades in mountainous terrain. There are four existing short tunnels along the alignment in San Francisco that extend through Potrero Hill, Hunter’s Point, and the ridge at Candlestick Point. These tunnels are being modified as part of the PCEP to accommodate HSR and Caltrain trains, and no further modifications are proposed as part of the HSR project.

**2.4.4.4 Elevated Profile**

Elevated guideway track profiles or viaducts (Figure 2-10) can be used in urban areas where extensive road networks must be maintained. An elevated guideway must have a minimum clearance of approximately 16.5 feet over roadways and approximately 24 feet over railroads. Pier supports are typically approximately 10 feet in diameter at the ground. Such structures could also be used to cross waterbodies; even though the trackway might be at grade on either side, the width of the water channel could require that a bridge be built to support a track contiguous with the at-grade guideway on either bank. Viaduct would be used for the flyover<sup>6</sup> that carries the tracks connecting the mainline tracks to the north end of the Brisbane LMF and would be used through downtown San Jose under Alternative B.

<sup>6</sup> A flyover is an elevated structure that carries one rail alignment over another.

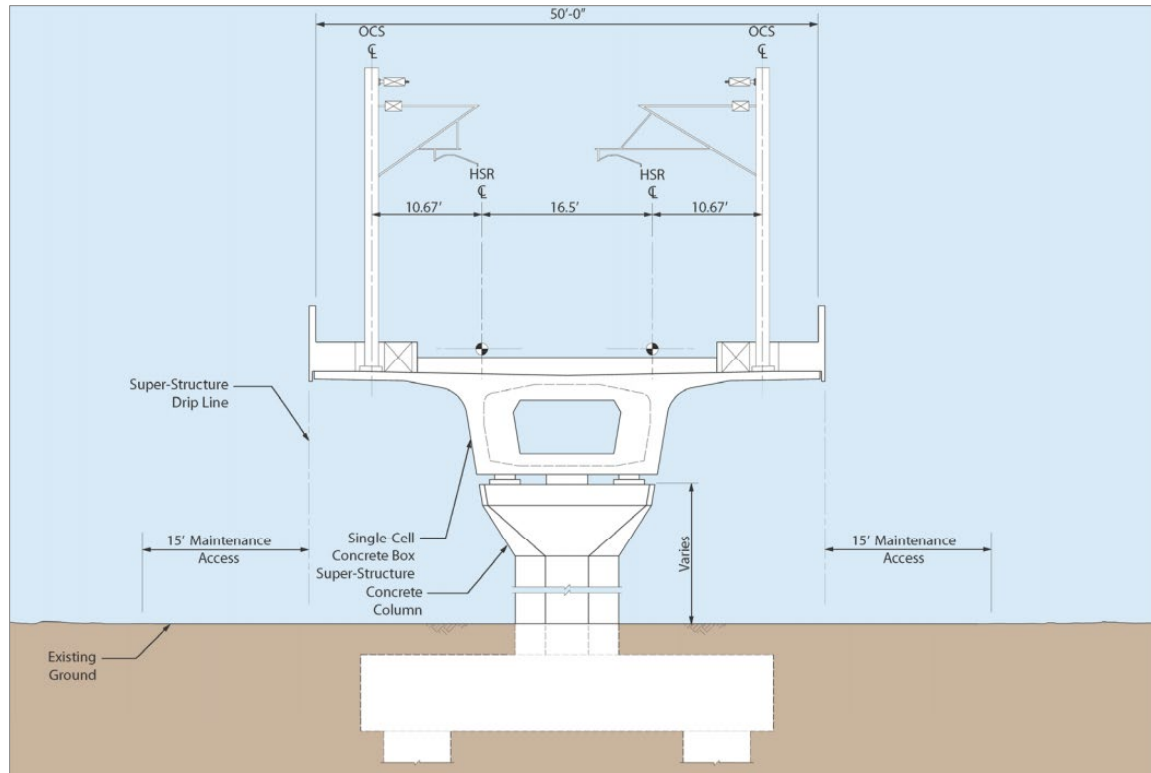

FEBRUARY 2017

**Figure 2-10 Two-Track Viaduct**

#### 2.4.4.5 Straddle Bents

Where an HSR elevated track profile crosses over a roadway or railway on a very sharp skew (degree of difference from the perpendicular), a straddle bent is used to place the piers outside the functional or operational limit of the roadway or railway.

As illustrated on Figure 2-11, a straddle bent is a pier structure that spans (or straddles) the functional or operational limit of a roadway, highway, or railway. Typical roadway and highway crossings that have a smaller skew angle (i.e., approaching the perpendicular) generally use intermediate piers in medians and span the functional right-of-way. However, for larger skew-angle crossing conditions, median piers would result in excessively long spans that are not feasible. Straddle bents that clear the functional right-of-way can be spaced as needed (typically 110 feet apart) to provide feasible span lengths for bridge crossings at larger skew angles. Straddle bents are used extensively within the San Jose Diridon Station Approach Subsection under Alternative B, where viaduct structures would be located above existing roadway and railway.

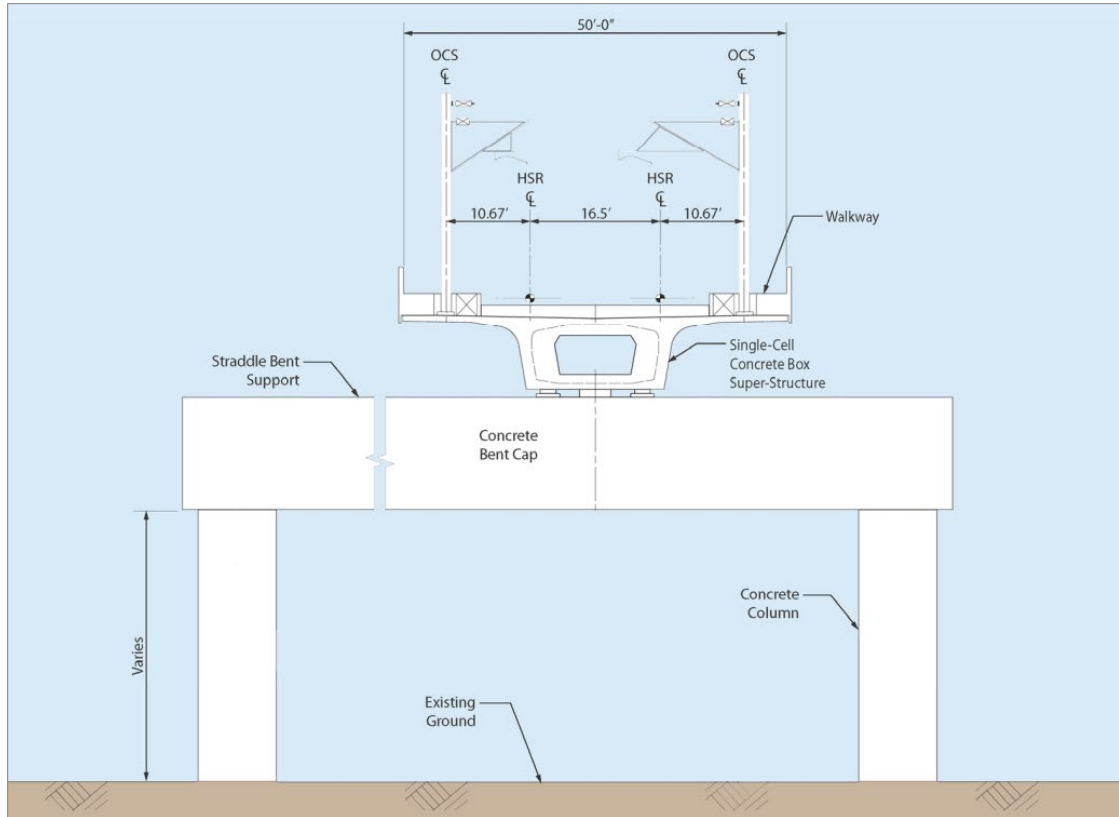

FEBRUARY 2017

Figure 2-11 Typical Straddle Bent Cross Section

## 2.4.5 Safety and Security Modifications

### 2.4.5.1 At-Grade Crossing Improvements

Consistent with FRA safety guidelines for HSR systems with operating speeds of up to 110 mph, the blended system would install safety improvements at the existing at-grade crossings to create a “sealed corridor” that would reduce conflicts with automobiles and pedestrians. Safety improvements would include four-quadrant gates extending across all lanes of travel and median separators to channelize and regulate paths of travel. These gates would prevent drivers from traveling in opposing lanes to avoid the lowered gate arms. Pedestrian crossing gates would be built parallel to the tracks and aligned with the vehicle gates on either side of the roadway.

Depending on the existing at-grade crossing configurations, one of six four-quadrant gate applications (illustrated on Figure 2-12, Figure 2-13, and Figure 2-14) would be installed at at-grade crossings along the Project Section. These applications would specify the improvements at each at-grade crossing, including the number of vehicle and pedestrian gates, and the need for channelization or raised medians.

Application A

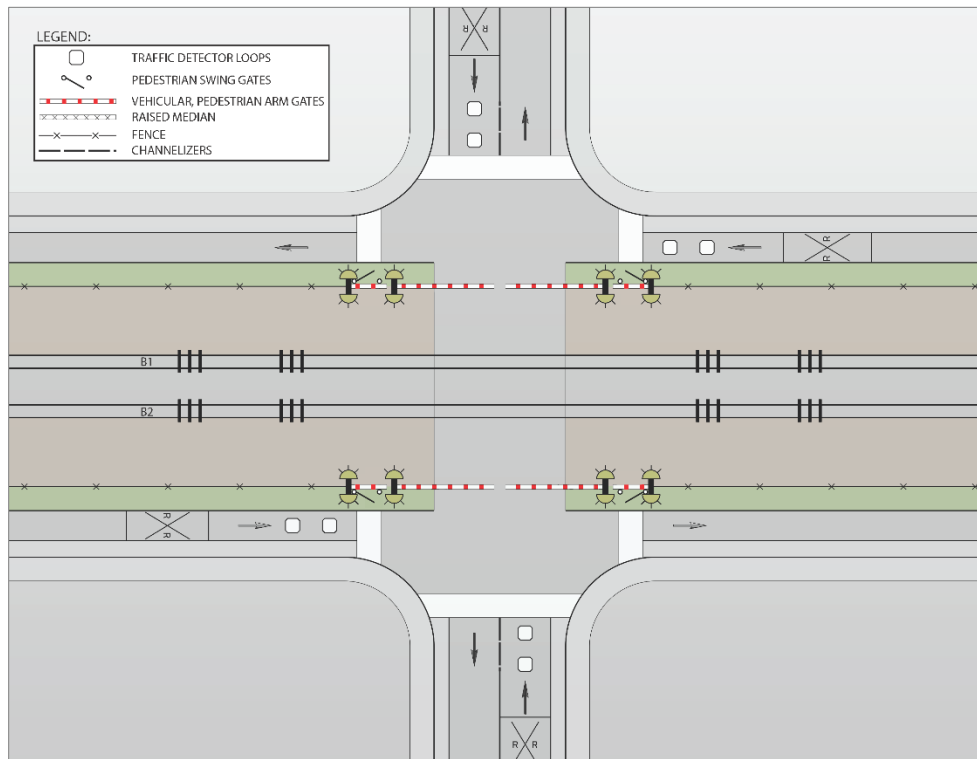

Application B

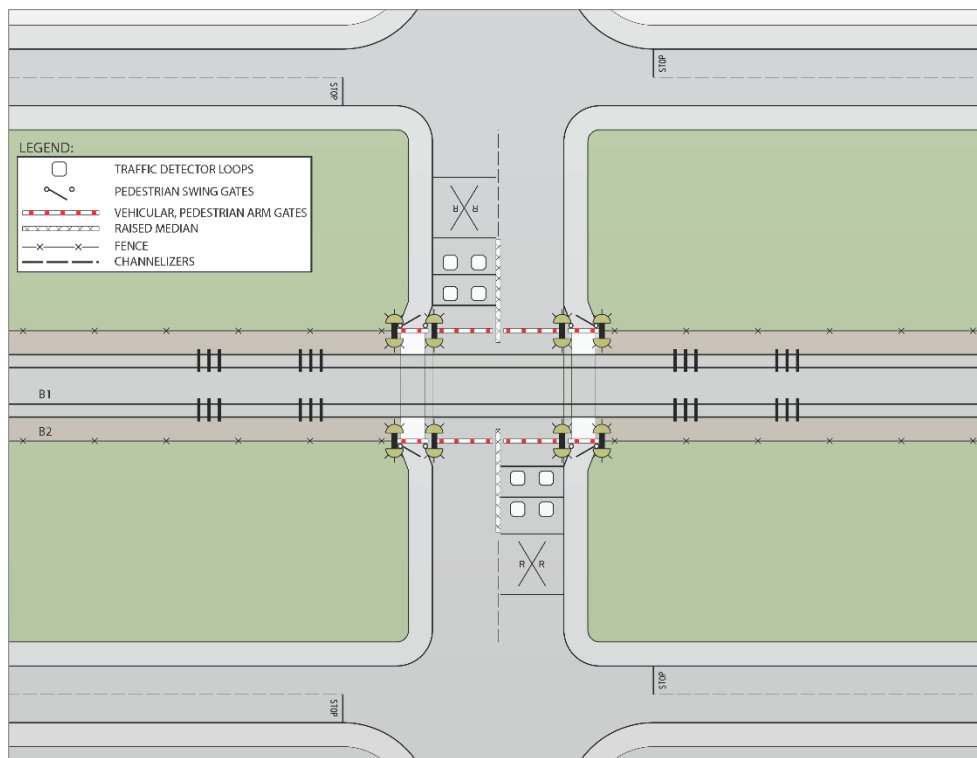

MAY 2019

Figure 2-12 Applications of Four-Quadrant Gates (Applications A and B)



Application B1

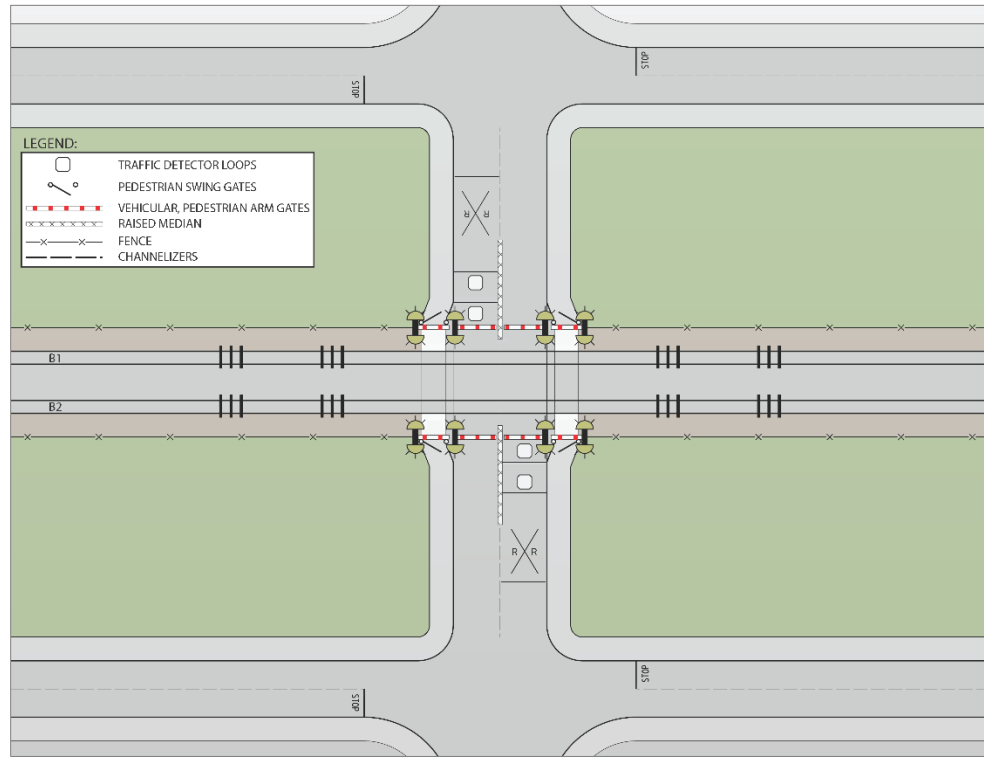

Application C

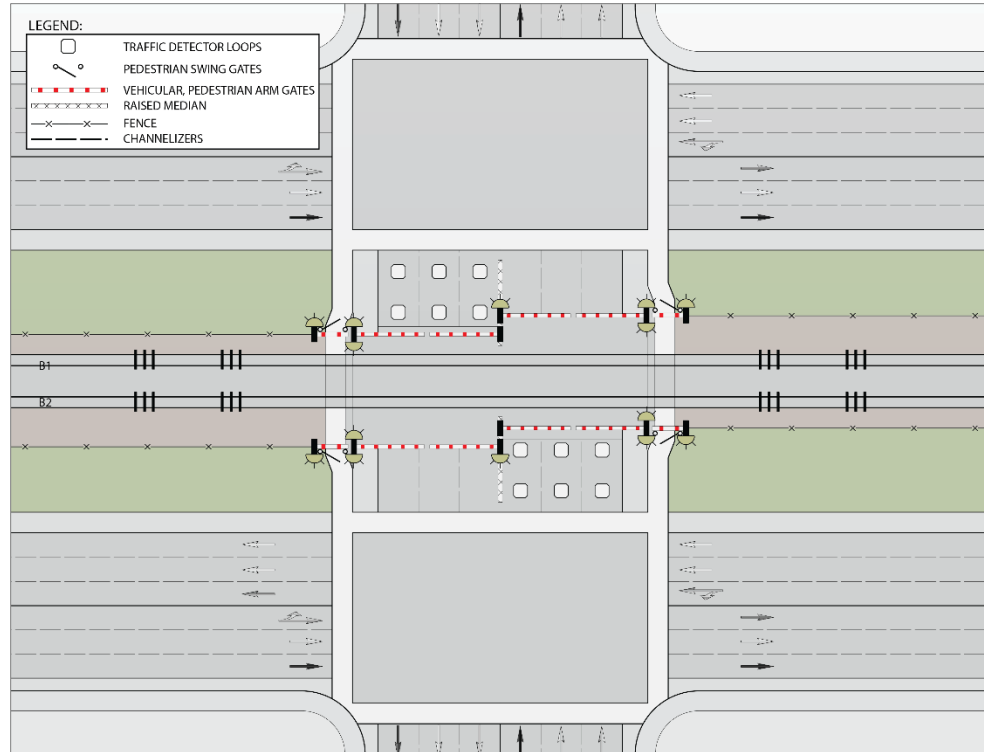

MAY 2019

Figure 2-13 Applications of Four-Quadrant Gates (Applications B1 and C)

**Application D**

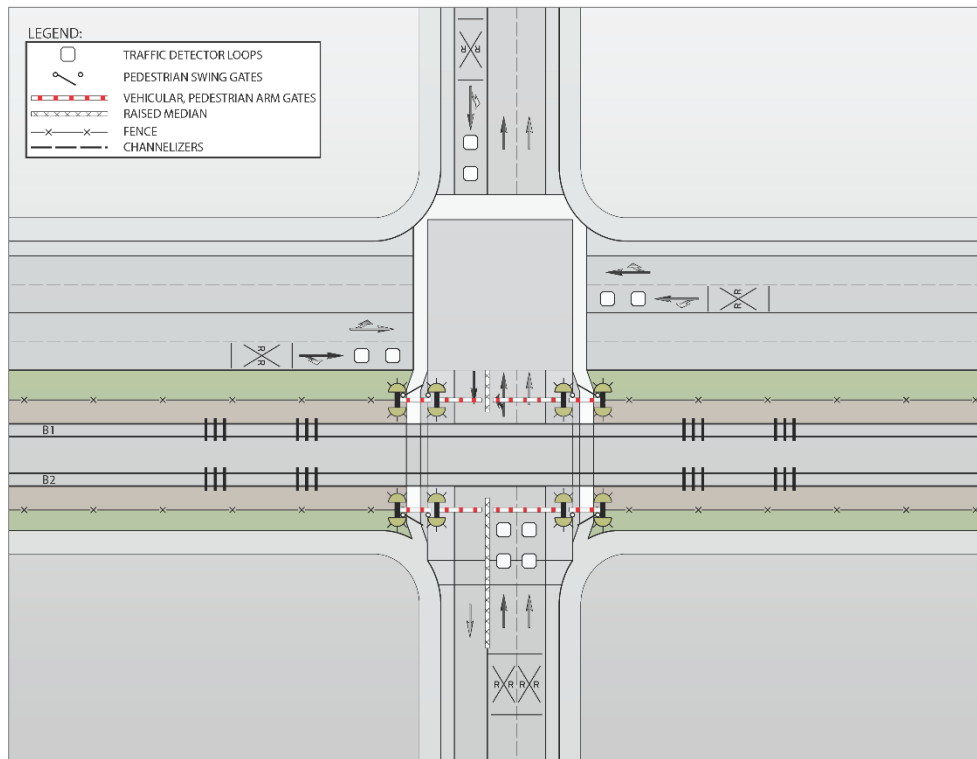

**Application E**

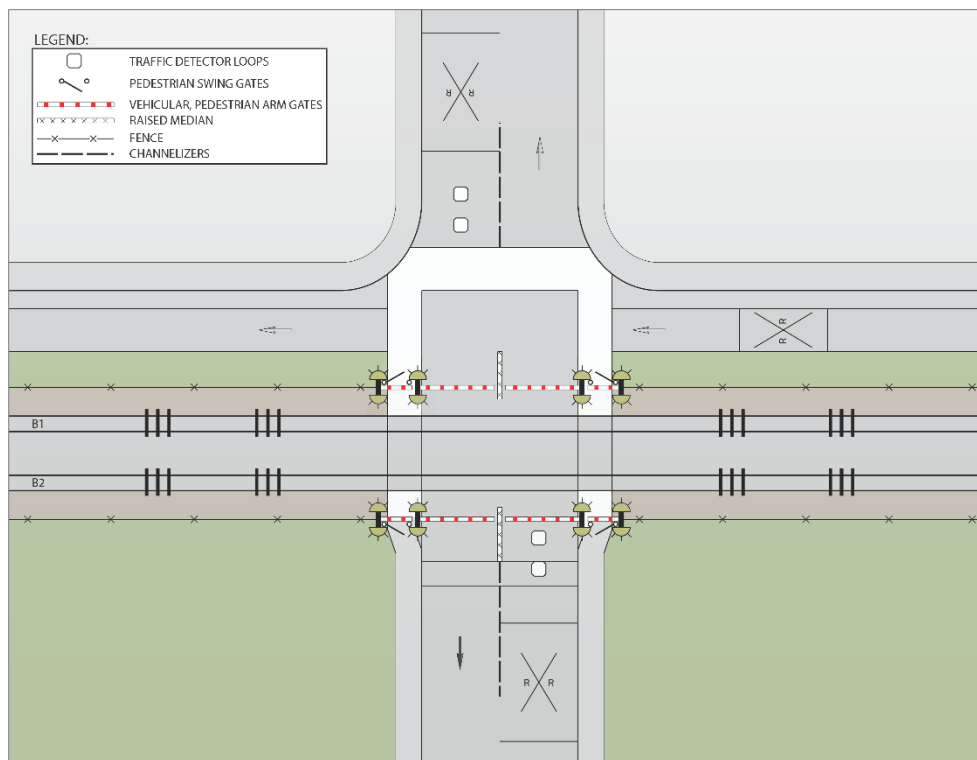

MAY 2019

**Figure 2-14 Applications of Four-Quadrant Gates (Applications D and E)**

### 2.4.5.2 Caltrain Station Safety Improvements

Depending on the alternative selected, between 9 and 12 of the existing 27 Caltrain stations between Fourth and King Street in San Francisco and West Alma Avenue in San Jose would require varying degrees of modifications to accommodate HSR trains passing through or stopping at the stations (illustrated on Figure 2-15). Station modifications would occur at proposed HSR station locations, at locations where substantial track modifications may be required, and at existing Caltrain stations where safety improvements would be required to accommodate HSR trains passing through stations.

Major safety improvements would be required at the Broadway and Atherton Caltrain Stations (Alternatives A and B) and College Park Caltrain Station (Alternative A only). At these stations, new northbound outboard platforms would be built to eliminate the need for passengers to board and alight from the train between the active tracks. This would improve the safety of passengers during train operations and eliminate the hold-out rule requiring oncoming trains to stop outside the station zone until the passengers are safely clear. Figure 2-16 illustrates the required modifications to eliminate the hold-out rule at these existing stations.

The safety of passengers waiting on Caltrain platforms when HSR and Caltrain trains pass through existing stations at speeds of up to 110 mph would be maintained by implementing additional safety improvements at station platforms that warn passengers to move away from the edge of the platforms prior to the approach of HSR and Caltrain trains. These safety improvements could include increasing the width of the tactile platform strips that are currently installed at Caltrain stations, modifying the tactile platform strips to use raised bars instead of raised dots, and providing additional visual and audible warnings of approaching HSR trains. PCJPB, as the owner and operator of the Caltrain stations, would be responsible for design and implementation of safety improvements at Caltrain station platforms. These modifications would be subject to further review and analysis based on the Authority's ultimate vehicle procurement and would be the subject of future blended system planning and agreement between the Authority and PCJPB.

#### *Definition of Hold-Out Rule*

**Hold-out rule** is the rule enforced at Caltrain stations that requires passengers to board and alight the train from between the active tracks. An oncoming train is detained outside the station until the passengers are clear of the active tracks.



Figure 2-15 Proposed Caltrain Station Modifications

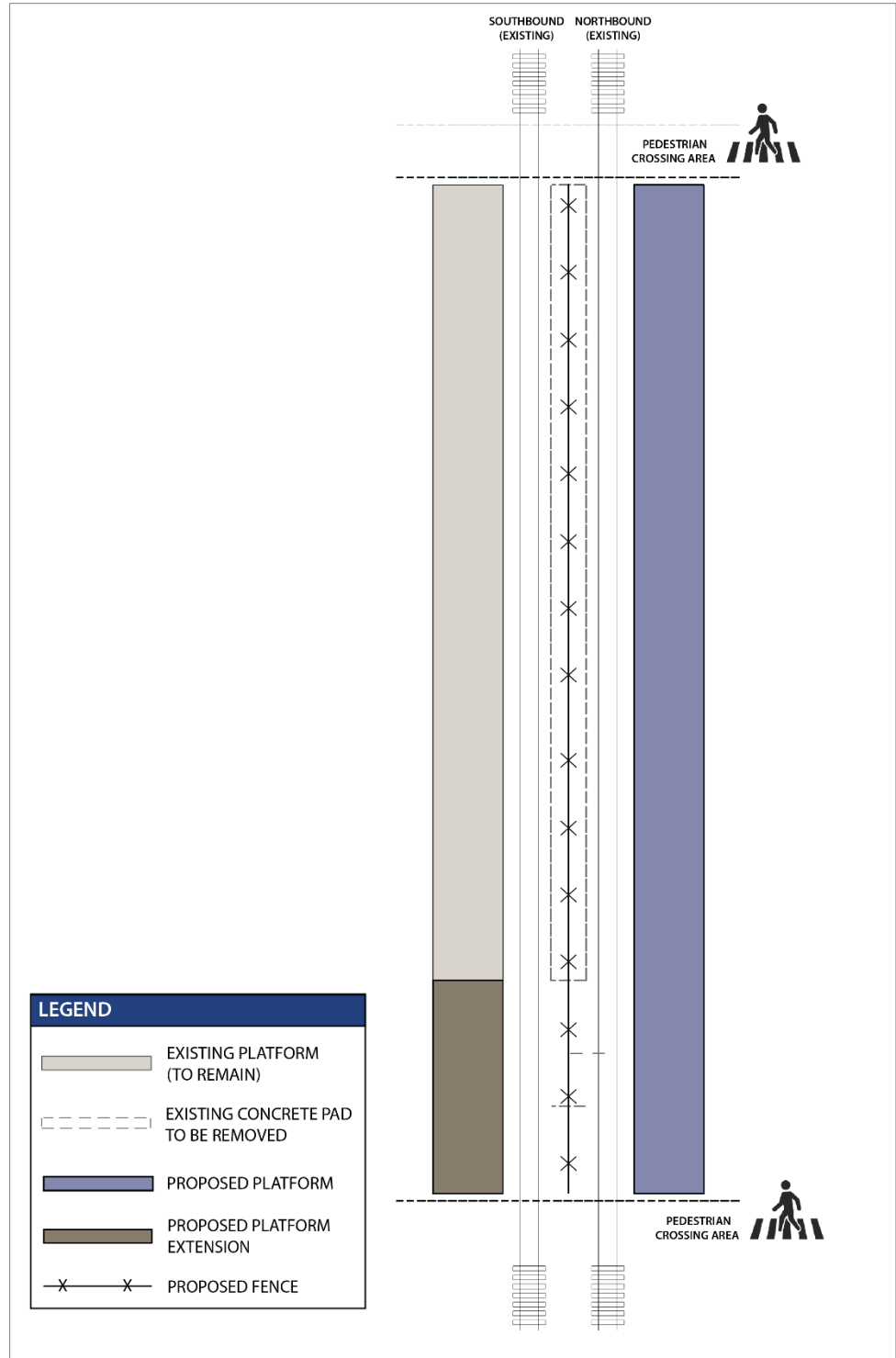

MAY 2019

Figure 2-16 Illustration of Hold-Out Rule Stations

### 2.4.5.3 Perimeter Fencing of the Right-of-Way

The Authority would install fencing at the at-grade crossings and along the perimeter of the Caltrain right-of-way where it does not already exist. Consistent with Caltrain's design standards, existing fencing would be extended to adjacent structures to close any gaps. Figure 2-17 illustrates existing perimeter fencing of railroad rights-of-way.



Figure 2-17 Photograph of Perimeter Fencing of Right-of-Way

### 2.4.6 Traction Power Distribution

The blended system would use the traction power distribution system installed by Caltrain as part of the PCEP for the distribution of electric power to the trains. This system would provide 130 to 140 single-track miles of OCS between San Francisco and San Jose. The OCS would consist of a series of mast poles approximately 23.5 feet higher than the top of the rail, with contact wires suspended from the mast poles. The train would have an arm, called a pantograph, to maintain contact with this wire, providing power to the train. Typical OCS configurations are illustrated in the typical cross sections (Figures 2-5 through 2-11). The OCS would be powered from a 25-kilovolt, 60-Hertz, single-phase, alternating current supply system consisting of traction power substations (TPSS), one switching station, and paralleling stations.<sup>7</sup>

Relocation of the OCS poles and wires installed by Caltrain as part of the PCEP would be required as part of the HSR project where track modifications would shift tracks more than 1 foot horizontally. Additionally, the project would build new OCS poles and wires for dedicated HSR infrastructure associated with the Brisbane LMF or the viaduct structures in the San Jose Diridon Station Approach Subsection under Alternative B.

Beyond the infrastructure installed as part of the PCEP, HSR trains may require additional equipment (e.g., transformers) to handle HSR electrical loads at the PCEP TPFs. Any

<sup>7</sup> Traction power substations are typically 150 feet by 200 feet in size and include transformers that step down the voltage of power provided by the utility to that needed for the OCS. Switching stations are typically 80 feet by 160 feet in size and would be installed at the midpoint between traction power substations as a phase break to ensure power supplies from each traction power substation are isolated from each other. Paralleling stations are typically 40 feet by 80 feet and would be installed between traction power substations and switching stations to maintain the autotransformer system and system operating voltages. Traction power substations, switching stations, and paralleling stations would be equipped with circuit breakers, switching equipment, and oil-filled transformers.

additional equipment installed at these facilities would be similar in terms of size and capacity to the Caltrain equipment.

In addition to the traction power provided through the PCEP infrastructure, a single TPSS would be built in the San Jose Diridon Station Approach Subsection on the east side of the Caltrain corridor under Alternative B. The TPSS would encompass approximately 32,000 square feet (200 feet by 160 feet).

Permanent emergency standby generators for the Project Section would be located at stations and the LMF. These standby generators must be tested (typically once a month) in accordance with National Fire Protection Association 110/111 to maintain their readiness for backup and emergency use. If needed, portable generators could also be transported to other trackside facilities to reduce the potential impacts of power failures on system operations.

### 2.4.7 Signaling, Train-Control Elements, and Communication Facilities

HSR would install a radio-based communications network to maintain communications and share data between the HSR trains and the operations control center. Each communications radio tower would consist of an 8- by 10-foot communications equipment shelter and a 6- to 8-foot-diameter communications tower extending 100 feet above top-of-rail at approximately 2.5-mile intervals. Where possible, these facilities would be co-located at an existing Caltrain TPSS, switching station, paralleling station, or Caltrain station as illustrated on Figure 2-18. Where communications towers cannot be co-located with other Caltrain facilities, the communications facilities would be sited in an approximately 20- by 15-foot fenced area near the Caltrain corridor. For the purposes of environmental clearance, some of the standalone locations have two identified site options but only one would ultimately be implemented.

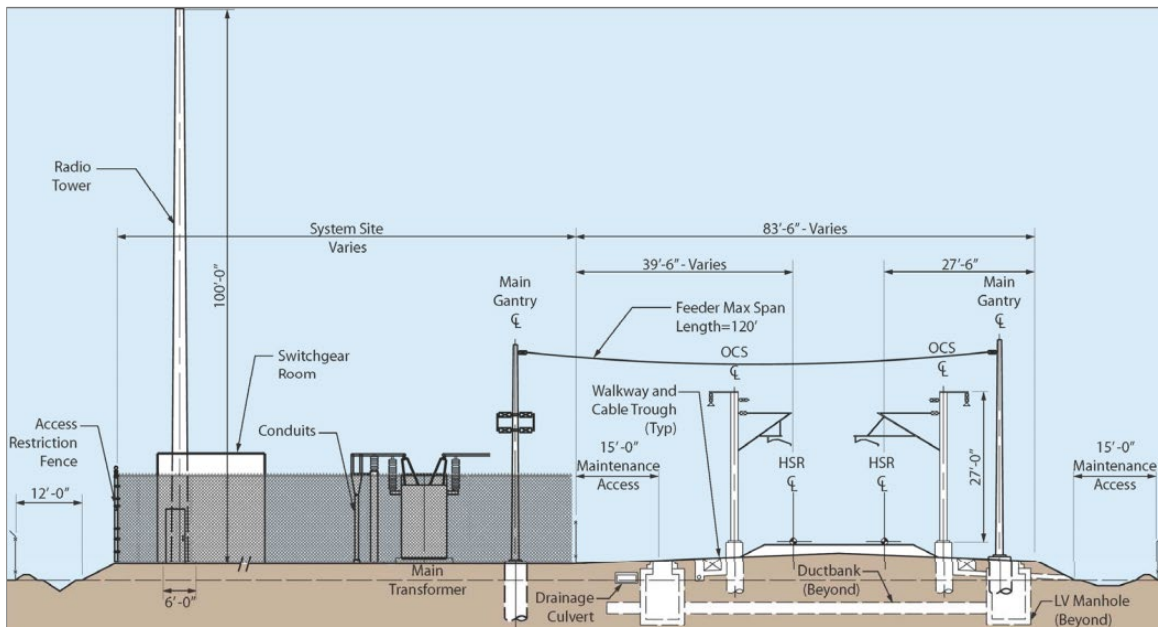

**Figure 2-18 Typical Cross Section of At-Grade Profile with Traction Power, Signaling, and Train Control Features**

## 2.4.8 Maintenance Facilities

The California HSR System includes four types of maintenance facilities: heavy maintenance facility, LMF, maintenance of infrastructure siding, and maintenance of way facility. Most HSR project sections would have maintenance of way facilities. A number of overnight layover and servicing facilities (maintenance of infrastructure sidings) also would be distributed throughout the HSR system. In addition, the system would have a single heavy maintenance facility in the Central Valley, as well as two LMFs statewide. More information on the heavy maintenance facility sites considered can be found in the *Merced to Fresno Section Final Environmental Impact Report/Environmental Impact Statement* and *Fresno to Bakersfield Section Final Environmental Impact Report/Environmental Impact Statement* (Authority and FRA 2012, 2014).

Within the Project Section, an LMF would be necessary to support the San Francisco terminal station operations by dispatching freshly inspected and serviced trains and crews to begin revenue service throughout the day, along with providing daily, monthly, and quarterly maintenance of HSR trainsets. Maintenance activities would include train washing, interior cleaning, wheel truing, testing, and inspections. These activities may occur between runs or as a pre-departure service at the start of the revenue day. Additionally, the LMF would be used as a service point for any trains in need of emergency services.

The LMF would occupy a site adjacent to the mainline tracks with an estimated length of about 7,500 feet and footprint of approximately 100 to 110 acres. The optimal LMF layout includes direct main track access using double-ended yard leads, grade-separated flyovers, interlockings, design speeds of 60 mph, and universal crossovers at the main tracks. Yard tracks would need to hold two trainsets and two runaround/transfer tracks to move trains from one end of the facility to the other. Optimal design would also include 1,400-foot transition tracks to allow trains to reduce or increase speed as necessary upon entering or exiting the LMF and transition to the automatic train control (ATC) system.

## 2.4.9 Dedicated High-Speed Rail Infrastructure

Under Alternative B, 3 to 6 miles of the southernmost portion of the Project Section would entail dedicated HSR track on a fully grade-separated and access-controlled guideway designed to accommodate higher speeds than those allowable in the blended system. HSR design and operations in this portion of the project would include protection barriers (fences and walls) and state-of-the-art communication, access control, and monitoring and detection systems to keep people, animals, and obstructions off the tracks.

Dedicated HSR track as part of Alternative B would ascend to viaduct north of the San Jose Diridon Station and continue on viaduct south of the station to West Alma Avenue. In instances where it is necessary to keep the profile of the elevated HSR guideway beneath certain height requirements, existing roadways would be moderately depressed to maintain vertical clearance requirements for vehicles, as illustrated on Figure 2-19.



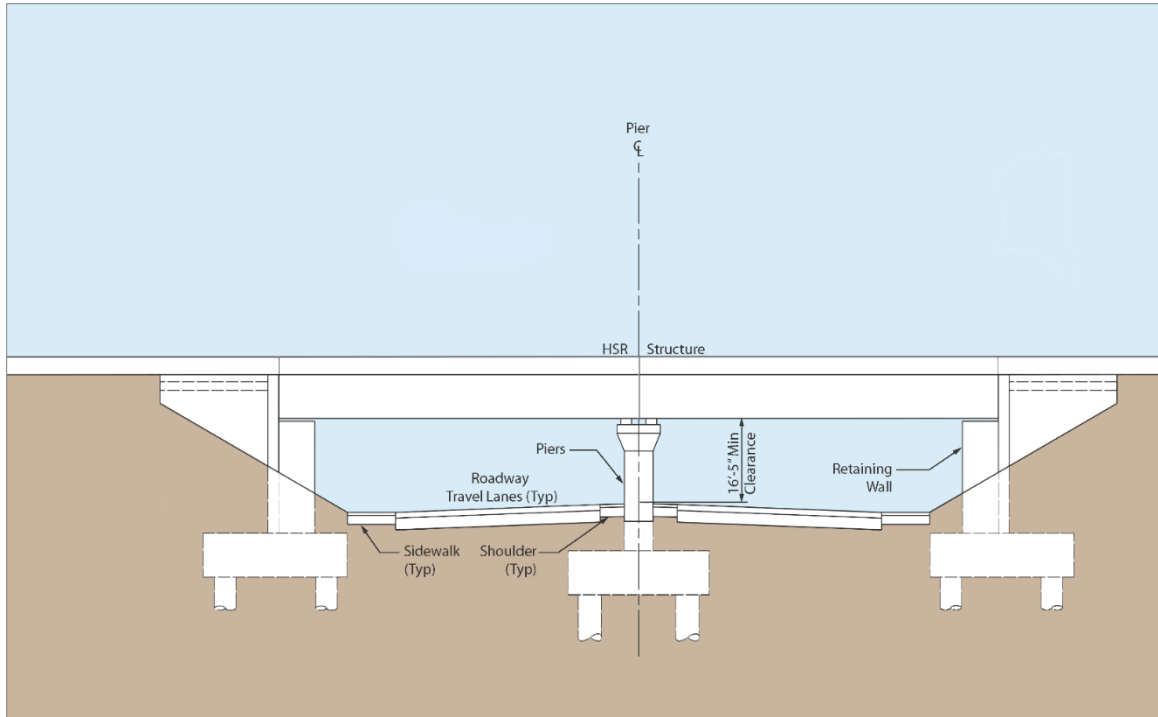

FEBRUARY 2017

**Figure 2-19 Typical Cross Section of Roadway Grade-Separated Beneath HSR Guideway**

## 2.5 Alternatives Considered during Alternatives Screening Process

Following the Tier 1 decisions in 2005 and 2008 based on the programmatic documents, the Authority, in cooperation with the FRA, began the environmental review process for the Project Section. This process began in December 2008 with the publication of a NEPA Notice of Intent (NOI) and CEQA Notice of Preparation (NOP) to evaluate a fully grade-separated four-track system along the Caltrain corridor between San Francisco and San Jose. The Authority subsequently issued a revised NOP in January 2009. In 2009, the Authority and FRA completed project scoping and in 2010 made the alternatives screening documents for the corridor publicly available. The proposed four-track system generated concerns from communities along the Caltrain corridor because of the perceived magnitude of impacts on environmental and community resources. In response to these concerns, the Authority suspended further work on the Project Section EIR/EIS in mid-2011 so that it could consider the potential to blend HSR and Caltrain operations within a smaller project footprint. In November 2011, in the Draft 2012 Business Plan, the Authority proposed blended operations for the Project Section north of Scott Boulevard, which would provide HSR service between San Francisco and San Jose on a predominantly two-track system shared with Caltrain.

In 2012, the Authority adopted the *California High-Speed Rail Program Revised 2012 Business Plan: Building California's Future* (2012 Business Plan), which concluded that, as allowed by law, the HSR project to be studied north of Scott Boulevard in the Project Section would operate as a blended system (Authority 2012b). Other actions establishing the framework for blended operations along the Caltrain corridor included adoption of the *MTC Resolution No. 4056 Memorandum of Understanding: High-Speed Rail Early Investment Strategy for a Blended*

*System on the Peninsula Corridor* (MOU)<sup>8</sup> (Metropolitan Transportation Commission [MTC] 2012) and passage of Senate Bills (SB) 1029<sup>9</sup> and 557.<sup>10</sup> In May 2016, the Authority rescinded the prior 2008 NOI and revised 2009 NOP for the Project Section and issued a new NOI and NOP to evaluate a predominantly two-track blended system.

The alternatives development and consideration process was iterative from 2009 to 2019 as illustrated on Figure 2-20. The Authority solicited public and agency comments on the range of alternatives that should be studied in the EIR/EIS multiple times, including the initial EIR/EIS scoping period in 2009 and during alternative analysis and supplemental alternatives analysis document preparation in 2010. After the blended system framework was established in 2012–2013, the Authority engaged the public again in 2015, reinitiating EIR/EIS scoping for the blended system in 2016, and continued alternatives refinement from 2016 to 2018. Interagency coordination also informed the development of alternatives for consideration. After identifying the initial group of potential alternatives, plans, concepts, and cross sections were developed as necessary to support early consideration. The initial alternatives were developed and screened in coordination with the NEPA/404/408 Integration process.

NEPA/404/408 Integration is a formal process by which the FRA, Authority, USACE, and USEPA coordinate on the identification, preliminary technical evaluation, and evaluation of alternatives in a NEPA document for consistency between NEPA requirements and the requirements of CWA Section 404 (concerning waters/wetlands) and Rivers and Harbors Act Section 408 (concerning federally authorized flood control projects). The FRA, Authority, USACE, and USEPA signed an MOU that established a three-step “checkpoint” process to govern interagency coordination for the integration process (see text box). The following summarizes the alternatives development and analysis process and results.

#### NEPA/404/408 Integration Process

The MOU between the FRA, the Authority, USACE, and USEPA establishes a three-part “checkpoint” process for integrating NEPA and the requirements of CWA Section 404 and Rivers and Harbors Act Section 408:

- **Checkpoint A**—The USACE and USEPA review the Authority and FRA’s identification of the project’s Purpose and Need and concur that it is fully described.
- **Checkpoint B**—The USACE and USEPA review the Authority’s identification of alternatives for full evaluation in the EIR/EIS and concur that the range of alternatives is reasonable prior to release of the Draft EIR/EIS.
- **Checkpoint C**—The USACE and USEPA review the Authority’s identification of the least environmentally damaging practicable alternative and concur that it meets Section 404 and Section 408 requirements.

### 2.5.1 High-Speed Rail Project-Level Alternatives Development Process

An EIR/EIS is required to analyze the potential impacts of a range of reasonable alternatives (14 California Code of Regulations [Cal. Code Regs.] § 15126.6; 40 C.F.R. § 1502.14(a)). Under CEQA, the alternatives are to include a No Project Alternative and a range of potentially feasible alternatives that could (1) meet most of the project’s basic objectives and (2) avoid or substantially lessen one or more of the project’s significant adverse impacts (14 Cal Code Regs. § 15126.6(c)). The lead agency must describe its reasons for excluding other potential alternatives when considering alternatives for evaluation in the environmental document. Under the “rule of reason,” an EIR is required to study a sufficient range of alternatives to permit a reasoned choice (14 Cal. Code Regs. § 15126.6(f)). CEQA does not require that all possible alternatives be studied.

<sup>8</sup> A nine-party agreement adopted in March 2012 to establish a funding framework for a blended system on the Caltrain corridor. Signatories include the Authority, MTC, PCJPB, San Francisco County Transportation Authority, San Mateo County Transportation Authority, Santa Clara Valley Transportation Authority, City of San Jose, City and County of San Francisco, and Transbay Joint Powers Authority.

<sup>9</sup> SB 1029, approved July 2012, amended the Budget Act of 2012 to appropriate funds for HSR projects in the San Francisco to San Jose corridor, consistent with the blended system strategy identified in the Authority’s 2012 Business Plan, and the MTC MOU.

<sup>10</sup> SB 557, passed by the Legislature and signed by the Governor in 2013, provided that any bond funds appropriated pursuant to SB 1029 would be used solely to implement a blended system approach.



SEPTEMBER 2019

Figure 2-20 Project Alternatives Development and Screening Process

Under NEPA, the alternatives analysis is “the heart of the environmental impact statement” (40 C.F.R. § 1502.14). Under Council on Environmental Quality (CEQ) regulations, an EIS is required to examine “all reasonable alternatives” to the proposed action, as well as the no-action alternative. The CEQ guidance also allows, when the number of potentially reasonable alternatives is very large, the lead agency to examine “a reasonable number of examples, covering the full spectrum of alternatives” (46 *Federal Register* [Fed. Reg.] 18026). Pursuant to Section 10(b) of the FRA’s *Procedures for Considering Environmental Impacts*, “It is entirely proper that the number of alternatives being considered should decrease as the environmental consideration process proceeds and as analysis reveals that certain alternatives would in fact be unreasonable” (64 Fed. Reg. 28546, 28550). The Authority and FRA considered the input of the public and interested resource agencies when developing the reasonable range of alternatives. Pursuant to CEQA and NEPA, the Authority and FRA held scoping meetings to invite public participation in defining the scope of the analysis, including the range of reasonable alternatives.

## 2.5.2 Alternatives Consideration Process and Chronology

The Authority and FRA used a tiered environmental review process to support tiered decisions for the HSR system. Tiering of environmental documents means addressing a broad program in a “Tier 1” environmental document, then analyzing the details of individual projects within the larger program in subsequent project-specific or “Tier 2” environmental documents. The Authority and FRA began the Tier 1 environmental review process with the *Final Program Environmental Impact Report/Environmental Impact Statement (EIR/EIS) for the Proposed California High-Speed Train System (Statewide Final Program EIR/EIS)* (Authority and FRA 2005), which deferred selection of a corridor between the Bay Area and Central Valley until completion of a second, more focused Program EIR/EIS.

The Authority and FRA completed the *Final Bay Area to Central Valley High-Speed Train (HST) Program Environmental Impact Report/Environmental Impact Statement (EIR/EIS)* (Bay Area to Central Valley Program EIR/EIS) (Authority and FRA 2008), which evaluated two network alternatives for linking the Bay Area and Central Valley—the Pacheco Pass and the Altamont Pass—and four alignment alternatives between San Francisco and San Jose—I-280, U.S. Highway (US) 101, and the Caltrain corridor (exclusive or shared guideway). The Caltrain corridor alternatives were a four-track system that would be fully grade separated. Figure 2-21 illustrates the range of alternatives considered in the Bay Area to Central Valley Program EIR/EIS.

In 2008, the Authority and FRA selected the Pacheco Pass network alternative, which used existing rail and transportation rights-of-way to the greatest extent feasible, minimizing impacts on wetlands and aquatic resources, other environmental resources, and communities (FRA 2008). Additionally, the Authority and FRA advanced shared HSR and Caltrain use of the Caltrain corridor between San Francisco and San Jose for further study in a Tier 2 project-level EIR/EIS, illustrated on Figure 2-22. The station locations advanced for Tier 2 study included a station in downtown San Francisco, a San Francisco International Airport (SFO) Station at Millbrae, a potential mid-Peninsula station in either Redwood City or Palo Alto, and a station at the San Jose Diridon Station. As a result of litigation, the Authority prepared the *Bay Area to Central Valley High-Speed Train Partially Revised Final Program Environmental Impact Report* (Bay Area to Central Valley Partially Revised Final Program EIR) (Authority 2012c) and made a new decision selecting the Pacheco Pass network alternative with the Caltrain corridor between San Francisco and San Jose (Authority 2012d, 2012e).

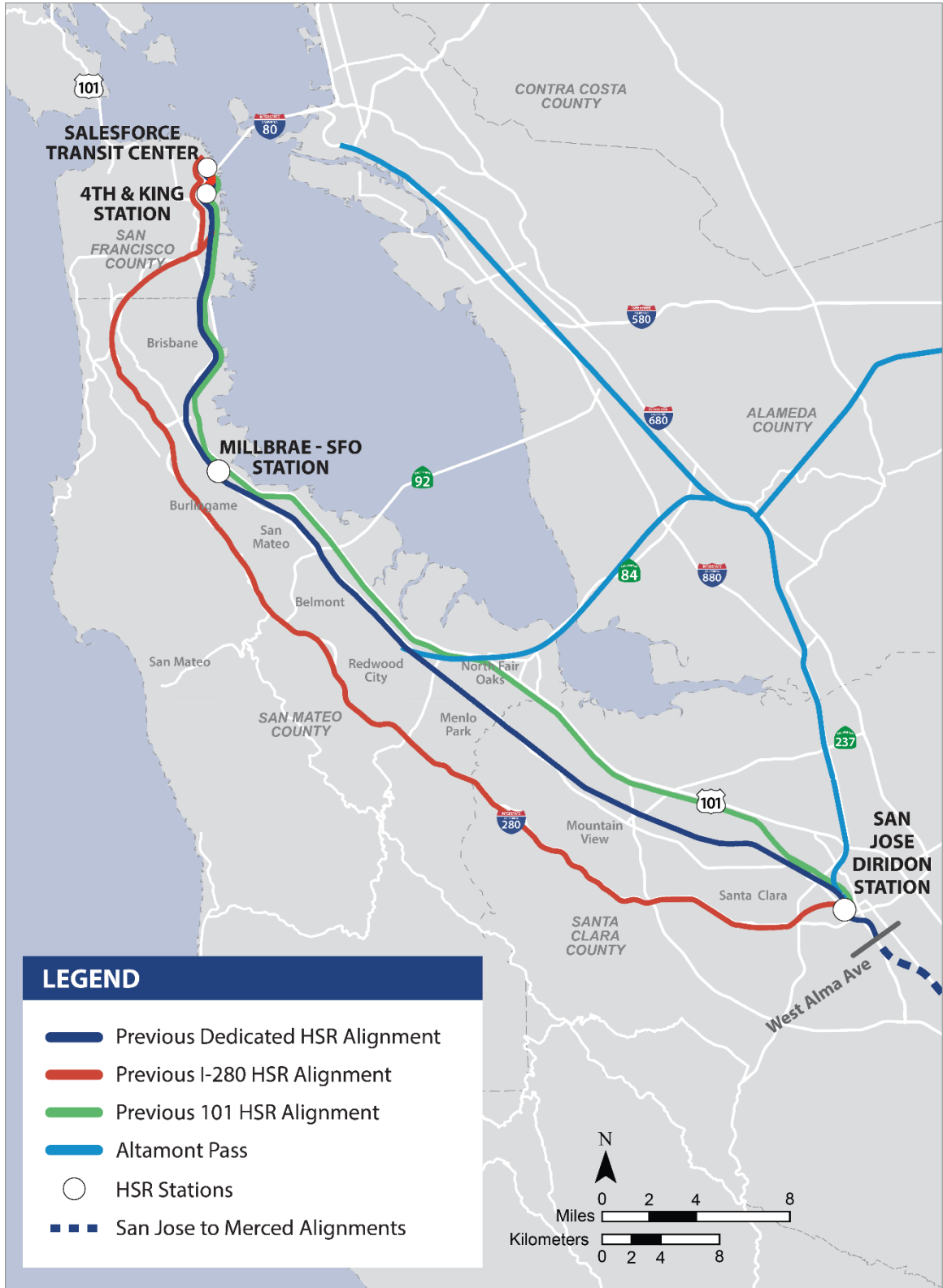

JUNE 2019

**Figure 2-21 Alignment Alternatives Considered and Eliminated in Tier 1 Planning**



**Figure 2-22 Tier 1 Decision as Foundation for Range of Alternatives in Tier 2 EIR/EIS—San Francisco to San Jose Project Section**

### 2.5.2.1 Initial Tier 2 Planning for Four-Track System (2009–2011)

The Authority issued an NOP on December 22, 2008, followed by a revised NOP clarifying the duration of the comment period on January 8, 2009 (State Clearinghouse No. 2008122079) and the FRA published an NOI (73 Fed. Reg. 79541) on December 29, 2008, to begin the Tier 2 project-level environmental review process. The proposed project was a fully grade-separated four-track system between San Francisco and San Jose with HSR sharing the corridor with Caltrain express commuter trains and accommodating continued UPRR freight train use of the corridor. Scoping meetings were held in 2009 and approximately 950 comment submissions were received during the scoping period. The feedback received during the scoping period informed the initial range of alternatives for the Project Section, as documented in the *Preliminary Alternatives Analysis Report for the San Francisco to San Jose Section (PAA)* in April 2010 and the *Supplemental Alternatives Analysis Report for the San Francisco to San Jose Section (SAA)* in August 2010 (Authority and FRA 2010a, 2010b). The Authority held community workshops and open houses to share information about the alternatives under consideration for the Project Section at that time.

#### Preliminary Alternatives Analysis (April 2010)

The PAA reconfirmed the decision to carry forward a four-track, grade-separated shared-use alignment between San Francisco and San Jose. The alternatives analysis primarily addressed the potential vertical configurations of the alignment alternatives within the Caltrain shared-use corridor. The vertical options considered in alternatives development included aerial viaduct; berm; at grade (existing Caltrain grade); trench; covered trench or tunnel; and deep tunnel.<sup>11</sup> These options were assessed based on their ability to meet Purpose and Need and project objectives, constructability, and environmental considerations. Additionally, public and agency engagement informed the evaluation of alignment alternatives; as a result of this engagement, the Authority evaluated tunnel options throughout the corridor and limited the use of high berms in commercial or residential areas where they would reduce connectivity and mobility or where a strong local opposition to this type of structure was expressed. Illustrated on Figure 2-23, the PAA recommended carrying forward for further evaluation a variety of vertical design options between San Francisco and San Jose.

The PAA also recommended further evaluation of stations in downtown San Francisco, Millbrae, and San Jose Diridon Station, as well as a potential mid-Peninsula station in Redwood City, Palo Alto, or Mountain View. The Authority considered the current Mountain View Caltrain Station (which was not identified in the program-level documents) as an additional potential mid-Peninsula station at the request of the City of Mountain View.

---

<sup>11</sup> An aerial viaduct consists of concrete structures supported by columns. A berm consists of earthen fill with 2:1 side slopes or within retaining walls. At-grade track is typically at the level of the surrounding ground surface or is sometimes elevated or below grade if that is the configuration of the existing Caltrain tracks; along much of its alignment, the existing Caltrain track is on a low berm several feet off the ground. A covered trench or tunnel is an excavated trench covered partially or fully with a deck to allow streets or other uses above the track. A deep tunnel is typically a bored tunnel with ventilation shafts.



JUNE 2019

**Figure 2-23 Alignment Alternatives and Station Locations Carried Forward from the Preliminary Alternatives Analysis**



### Supplemental Alternatives Analysis (August 2010)

The SAA modified the recommendations presented in the PAA based on consultation with local cities and agencies, constructability factors, cost, and the goals of minimizing displacements and impacts on communities and construction-related disruption to Caltrain. Based on these considerations, the report identified three basic design options for the alignment alternatives. Design Option A relied predominantly on at-grade and aerial structure solutions to travel the length of the San Francisco to San Jose corridor. Design Options B and B1 relied on at-grade, aerial, trench and tunnel design solutions. All three design options included a new two-track covered trench or tunnel in San Francisco parallel to the existing Caltrain track.

Figure 2-24 depicts the alignment alternatives and station locations carried forward for further evaluation as a result of the SAA. These include the Design Option A, B, and B1 alignment alternatives and station locations in downtown San Francisco, Millbrae, and San Jose Diridon Station, as well as a potential mid-Peninsula station in Redwood City, Palo Alto, or Mountain View.

The proposed four-track system generated concerns from communities along the highly urbanized Caltrain rail corridor. The communities, including the potential mid-Peninsula station cities, expressed concerns about the magnitude of potential impacts on environmental and community resources due to the need for additional right-of-way acquisitions to accommodate the four-track system along the Project Section and the proximity of the corridor to sensitive residential land uses. Increased traffic generated by the HSR station and parking requirements were also local concerns. Additionally, the proposed four-track system would have required the construction of new at-grade and aerial tracks within jurisdictional areas of the San Francisco Bay Conservation and Development Commission (BCDC), which are described in Section 2.9.3, High-Speed Rail Development within the San Francisco Bay Conservation and Development Commission Jurisdictional Areas. In November 2010, the City of Palo Alto formally requested removal from consideration as a mid-Peninsula station.



JUNE 2019

**Figure 2-24 Alignment Alternatives, Station Locations, and Light Maintenance Facilities Carried Forward from the Supplemental Alternatives Analysis**

### **Potential Light Maintenance Facility Sites**

The SAA also evaluated potential LMF sites. Sites were identified in accordance with the Authority's preliminary siting criteria for maintenance facilities, which described the facility design and locational criteria to meet the functional requirements for an LMF between San Francisco and San Jose (Authority 2009), including:

- **Site size**—The site must be large enough (approximately 100 acres) to accommodate storage and maintenance operations.
- **Proximity to the mainline tracks**—It is important that the LMF be immediately adjacent to the mainline tracks, to minimize the length of the lead track. Long lead tracks have the potential to disrupt communities and have noise and visual impacts.
- **Double-ended lead tracks**—The LMF should be a double-ended facility (i.e., capable of dispatching and receiving trains from both ends of the facility). Double-ended facilities increase operational flexibility and allow for efficient dispatch of track maintenance equipment in the event there is an issue with one of the lead tracks. A stub-ended track is a high-risk design and should be avoided when a double-ended facility is feasible.

Identifying potentially suitable sites between San Francisco and San Jose proved challenging in light of the dense urban development throughout the Project Section. Sites that could potentially accommodate an LMF were subjected to an initial screening process, which focused on the capacity of the sites to meet engineering and design guidelines established through the Authority's Technical Memoranda. This assessment resulted in the identification of four sites that were analyzed in the 2010 SAA (Authority and FRA 2010b) (Figure 2-25):

- Port of San Francisco (Piers 90–94)
- SFO
- West Brisbane
- East Brisbane

### **Light Maintenance Facility Alternatives Carried Forward as a Result of the Supplemental Alternatives Analysis**

The SAA evaluation focused on operational features of the potential LMF sites. Based on that assessment, the Port of San Francisco and SFO sites were withdrawn and the West Brisbane and East Brisbane sites were advanced for further evaluation.

The Port of San Francisco site was found to be operationally deficient because of its size, distance from the mainline tracks, and need to be 'stub-ended' (i.e., single access and egress), which would constrict operations. Acquiring the right-of-way to build the necessary lead tracks from this site to the Caltrain mainline tracks would be costly and running trains along the lead tracks would be disruptive to the adjacent dense urban neighborhoods. This site was therefore not recommended for further study.

The SFO site was adequately sized (100 acres), but operationally deficient because of its distance from the mainline track and need to be 'stub-ended'. Providing the necessary lead tracks from the SFO site to the Caltrain mainline tracks would be costly and require modifications to the US 101 Interchange. Furthermore, the SFO site was determined to be not available because the lease to the site had been renewed with the current tenants. This site was therefore not recommended for further study.

The East and West Brisbane sites provided adequate space (100 acres) to provide operational flexibility desired for a double-ended LMF. They are adjacent to the Caltrain mainline track, providing convenient and close connections to the HSR mainline tracks for both southbound and northbound access. Providing northbound and southbound access would support timely provision of trainsets to the San Francisco terminal station, and would facilitate switching trainsets out during normal operations. For these reasons, the two options at the Brisbane Bayshore site were recommended to be carried forward for further study.



MARCH 2019

**Figure 2-25 Light Maintenance Facility Sites—San Francisco to San Jose Project Section**

The Authority conducted additional assessment of these four sites as part of the *San Francisco to San Jose Project Section Checkpoint B Summary Report* (Authority 2019c), to consider the environmental impacts that would likely result from the development of each site and to identify

potential practicability constraints associated with the sites. This assessment is summarized in Section 2.5.2.3, Tier 2 Planning for Predominantly Two-Track Blended System (2013–2019).<sup>12</sup>

### **2.5.2.2 Transition to a Predominantly Two-Track Blended System (2011–2012)**

As stated earlier in Section 2.5, the Authority suspended further work on the Project Section EIR/EIS in mid-2011 to consider blended operations for the two services (Caltrain and HSR) within a smaller project footprint and determine the HSR service to be studied in the Tier 2 EIR/EIS. Several important legislative actions and implementation decisions followed the Authority’s proposal for blended operations for the Project Section in 2011. The framework for blended operations along the San Francisco Peninsula was memorialized in 2012 through four separate but related actions: Authority adoption of the 2012 Business Plan (Authority 2012b); MTC and MOU party adoption of the MTC Resolution No. 4056 MOU<sup>13</sup> (MTC 2012); and passage of SB 1029 and SB 557, which are described in more detail as follows:

- The 2012 Business Plan (Authority 2012b) proposed a blended system for the Peninsula, described as primarily a two-track system that would be shared by Caltrain and HSR service and other current passenger and freight rail tenants. The key improvements identified for the blended system included an upgraded signal system, electrification, and infrastructure upgrades that would be implemented by Caltrain. The 2012 Business Plan (Authority 2012b) further concluded that the HSR project to be studied in the Project Section EIR/EIS would be the blended system.<sup>14</sup>
- MTC Resolution No. 4056 MOU (MTC 2012) is a nine-party agreement to establish a *Funding Framework for a High-Speed Rail Early Investment Strategy for a Blended System in the Peninsula Corridor*. The early investment strategy identifies an interrelated program of projects to upgrade existing commuter rail service and prepare for a future HSR project with infrastructure that remains substantially within the existing Caltrain right-of-way. It would primarily utilize the existing track configuration on the Peninsula. The two interrelated projects funded by the early investment strategy are the installation of electric traction power infrastructure and purchase of electric passenger train equipment for commuter services.
- SB 1029 further defined the blended system by mandating that any funds appropriated for projects in the San Francisco to San Jose corridor, consistent with the blended system strategy identified in the 2012 Business Plan (Authority 2012b), would not be used to expand the blended system to an independently dedicated four-track system (SB 1029 § 1 and § 2).
- SB 557 provides that any bond funds appropriated pursuant to SB 1029 would be used solely to implement a primarily two-track blended system substantially within the existing Caltrain right-of-way and that any track expansion beyond the blended system approach would require the approval of all nine parties to MTC Resolution No. 4056 (MTC 2012).

### **2.5.2.3 Tier 2 Planning for Predominantly Two-Track Blended System (2013–2019)**

The framework for pursuing a blended system in the Project Section provided the foundation for a new Tier 2 planning effort focusing on a predominantly two-track blended system utilizing existing Caltrain track and remaining substantially within the existing Caltrain right-of-way. This

<sup>12</sup> The Authority recently reviewed and reassessed the 11 sites it considered during its initial screening process (See *Light Maintenance Facility Site Selection Evaluation: San Francisco to San Jose Project Section Memorandum* [Authority 2020b]). As part of that process, the Authority evaluated these sites with respect to their capacity to meet key design, engineering, and operational criteria and to their feasibility in light of roadway circulation impacts, cost, and other factors. This assessment confirmed that only the two Brisbane sites met both the design and engineering criteria for the LMF and would be feasible sites for development of this facility.

<sup>13</sup> The Authority and eight other Bay Area agencies (PCJPB, City and County of San Francisco, San Francisco County Transportation Authority, Transbay Joint Powers Authority, San Mateo County Transportation Authority, Santa Clara Valley Transportation Authority, City of San Jose, and MTC) approved the MOU in March 2012.

<sup>14</sup> The 2012 Business Plan was preceded by a conceptual analysis prepared for the PCJPB that determined that a blended system in the Caltrain corridor would be operationally viable and merited continued investigation (PCJPB 2012).

framework, combined with the spatial constraints of integrating with existing passenger and freight rail in an existing right-of-way, limited the range of potential alignment alternatives for the Project Section. Consequently, the alternatives development process for the blended system focused largely on blended system operations and achieving the objectives of predictable and consistent operational service travel times for both HSR and Caltrain service, while also providing consistency with the Proposition 1A, The Safe, Reliable, High-Speed Passenger Train Bond Act (Prop 1A) time requirements for system design.

After establishing the framework for blended system operations in 2012, the Authority and PCJPB studied the feasibility of different blended system operations scenarios, including the utility of passing tracks (PCJPB 2012, 2013). Passing tracks allow for faster-moving trains to bypass slower-moving trains, and have the potential to provide operational benefits associated with faster recovery from incidents or perturbations (disruption events) on the railway. Figure 2-26 illustrates the locations of the passing track options evaluated between 2013 and 2016.

### 2013 Passing Track Evaluation

The PCJPB conducted a study in 2013 that assessed the feasibility of different blended system operations scenarios and passing track options (PCJPB 2013). The results of the analysis on average HSR and Caltrain operational service times<sup>15</sup> from the 4th and King Street Station to the San Jose Diridon Station, relative to the No Project Alternative (baseline), are shown in Table 2-2. Based on this operational analysis, the Authority withdrew the North Four-Track and the South Four-Track Passing Track Options. The Short Middle Four-Track, Long Middle Four-Track, and Long Middle Three-Track Passing Track Options were retained for further evaluation in 2016.

**Table 2-2 2013 Evaluation of Passing Track Options**

Measure	Average Operational Service Times (minutes) <sup>1</sup>					
	No Project Alternative (Baseline) <sup>2</sup>	Short Middle Four-Track (6 mi)	Long Middle Four-Track (8 mi)	Long Middle Three-Track (16 mi)	North Four-Track (10 mi)	South Four-Track (8 mi)
HSR operational service time	N/A	45.6	44.9	45.3	47.8	46.1
Caltrain operational service time	59.9	61.0	60.6	60.2	61.8	60.6
<b>Determination</b>	N/A	Carried forward	Carried forward	Carried forward	Withdrawn	Withdrawn

Source: PCJPB 2013

mi = miles

mph = miles per hour

N/A = not applicable

<sup>1</sup> Average operational service times are for peak hour operations from 4th and King Street Station to San Jose Diridon Station, and assume 5-minute headways/separation for the corridor and 4-minute headways/separation at diverging and merging at junctions.

<sup>2</sup> The No Project Alternative (baseline) assumes a fully electrified Caltrain service operating up to six trains per hour per direction and speeds of up to 79 mph. Under the No Project Alternative, Caltrain would use existing areas of more than two tracks for passing operations. For blended conditions with the passing track options, Caltrain and HSR trains would be operating at 110 mph along the corridor.

<sup>15</sup> The blended service study evaluated the average service time, including station stops, for HSR and for Caltrain during peak hour operations. This report refers to peak hour average service time as *average operational service time*.



JUNE 2019

Figure 2-26 Passing Track Options Considered

### **North Four-Track Passing Track Option**

This option would entail a 10.2-mile-long four-track segment from the Bayshore Station to just north of Broadway Avenue in Burlingame, requiring track expansion alongside the Brisbane Lagoon. Based on the PCJPB blended operations analysis, the average operational service time from San Jose to San Francisco would be approximately 61.8 minutes for Caltrain and 47.75 minutes for HSR (PCJPB 2013). Compared to the other passing track options, this option would result in the slowest average Caltrain and HSR operational service times (approximately 1.5 to 3 minutes slower). The PCJPB blended operations analysis further reported that this option would have difficulty supporting operational service time differences for overtakes, would result in long Caltrain operational service times, and would produce a high level of signal congestion. For these reasons, the Authority withdrew the North Four-Track Passing Track Option from further consideration. Additionally, this passing track would have required the construction of new at-grade tracks within BCDC jurisdictional areas, which are described in Section 2.9.3.

### **South Four-Track Passing Track Option**

This option would construct a 7.8-mile-long four-track segment from just north of San Antonio Avenue in Palo Alto to south of the Lawrence Station in Santa Clara. Based on the PCJPB blended operations analysis, the average operational service time from San Jose to San Francisco would be approximately 60.6 minutes for Caltrain and 46.1 minutes for HSR (PCJPB 2013). Compared to other passing track options, this option would result in the second slowest average HSR operational service times (approximately 1.5 minutes slower than the fastest passing track option) and the third fastest Caltrain average operational service time (approximately 0.7 minute slower than the fastest passing track option), comparable to the Long Middle Four-Track Option. For these reasons, the Authority withdrew the South Four-Track Passing Track Option from further consideration.

### **2016 Passing Track Evaluation**

To assess the capacity and operational flexibility of the Caltrain corridor between San Francisco and San Jose on HSR and Caltrain, the Authority conducted an evaluation of a No Passing Track option and further evaluation of the three passing track options not eliminated because of the 2013 operational analysis—Short Middle Four-Track, Long Middle Four-Track, and the Long Middle Three-Track. While the 2016 operational analysis is a useful tool for comparison between passing track options, the *average operational service times* are not directly comparable to the previous 2013 analysis due to changes in assumptions with regard to headways. The operational analysis was accompanied by a preliminary evaluation of community impacts to determine the level of community disruption generated by each option. As shown in Table 2-3, the different options provide different average operational service times for HSR and Caltrain, with varying levels of disruption to the local communities.

This section provides a more detailed discussion of the factors affecting the determination of passing track options recommended for further consideration in the Draft EIR/EIS. Primary considerations included avoiding and minimizing community and environmental resource impacts and minimizing impacts on the existing passenger and freight rail systems operating within the Caltrain corridor. The Authority balanced these considerations with the objectives of predictable and consistent average operational service travel times, as well as consistency with Prop 1A travel time requirements for system design.<sup>16</sup> Based on this balancing approach, the Authority chose not to carry forward the Long Middle Four-Track Passing Track and Long Middle Three-Track Passing Track options because of their substantially greater level of community disruption and right-of-way acquisition, with comparatively little to no advantage in terms of average operational service times. The Authority carried forward the No Passing Track and Short

---

<sup>16</sup> Prop 1A requires the HSR system to be designed to have maximum non-stop service times of 30 minutes between San Francisco and San Jose and 2 hours and 40 minutes between San Francisco and Los Angeles Union Station. The Prop 1A time requirements are related to the physical design of the system and the capabilities of HSR trains, but are different than average operational service times discussed in this chapter, which are estimates of average peak hour service times, including station stops.



Middle Four-Track Passing Track Options as part of the two blended system alternatives because these options would have fewer impacts on adjacent communities than the Long Middle Four-Track and Long Middle Three-Track Options, while still being consistent overall with the project purpose and objectives.

**Table 2-3 2016 Evaluation of Passing Track Options**

Measure	No Project Alternative (Baseline) <sup>2</sup>	Passing Track Option			
		No Passing Track	Short Middle Four-Track (6 mi)	Long Middle Four-Track (8 mi)	Long Middle Three-Track (16 mi)
<b>Operational Analysis</b>					
HSR average operational service time (minutes) <sup>1</sup>	N/A	47.1	44.7	44.2	42.7
Caltrain average operational service time (minutes) <sup>1</sup>	62.2	62.5	65.0	60.9	58.6
<b>Community Considerations</b>					
Communities affected	N/A	None	San Mateo Belmont San Carlos Redwood City	San Mateo Belmont San Carlos Redwood City	San Mateo Belmont San Carlos Redwood City North Fair Oaks Atherton Menlo Park Palo Alto
Length of passing track adjacent to residential land uses (miles)	N/A	0	1.8	2.3	8.3
Potential number of affected at-grade crossings	N/A	0	0	6	16
Determination	N/A	Carried forward (Alternative A)	Carried forward (Alternative B)	Withdrawn	Withdrawn

Sources: Authority 2017a, 2019a, 2019b; City of Belmont 2017; City of Menlo Park 2016; City of Palo Alto 2017; City of Redwood City 2010; City of San Carlos 2009; City of San Mateo 2015

HSR = high-speed rail

mi = miles

N/A = not applicable

<sup>1</sup> Average operational service travel times are for peak hour operations from 4th and King Street Station to San Jose Diridon Station, and assume 3-minute headways/separation along the corridor and 2-minute headways/separation at junctions.

<sup>2</sup> The No Project Alternative (baseline) assumes a fully electrified Caltrain service operating up to six trains per hour per direction and speeds of up to 79 miles per hour. Under the No Project Alternative, Caltrain would use existing areas of more than two tracks for passing operations.

**No Passing Track Option**

Under the No Passing Track Option new passing tracks would not be built. Rather, HSR and Caltrain would use existing areas along the Caltrain corridor that have more than two tracks (South Terminal, Lawrence, North Fair Oaks, and Brisbane) to allow faster-moving trains to bypass slower-moving trains. The Millbrae Station would be expanded to a four-track station with dedicated HSR tracks, which would allow for new passing opportunities.

As shown in Table 2-3, the average Caltrain operational service time from San Jose to San Francisco (4th and King Street Station) with the No Passing Track Option would be approximately 62.5 minutes, approximately 0.3 minute (18 seconds) slower than under the baseline conditions associated with the No Project Alternative (Authority 2017a). The No Passing Track Option would be slower for HSR than the options with passing tracks, but the difference would be relatively small, and the comparatively slower HSR time than with passing tracks would not undermine the project purpose or objectives, and also would avoid right-of-way acquisition, temporary construction disruption, aesthetic impacts associated with new areas of passing track, and environmental and community impacts associated with construction of passing tracks. For these reasons the No Passing Track Option is evaluated in the Draft EIR/EIS as part of Alternative A.

### **Short Middle Four-Track Passing Track Option**

The Short Middle Four-Track Passing Track Option would be approximately 6 miles long between Ninth Avenue in San Mateo and north of Whipple Avenue in Redwood City. Most of this portion of the alignment is already grade separated, except for roadway crossings at 25th Street, 28th Street, and 31st Street in San Mateo. These crossings would be grade separated prior to construction of the passing track as part of the 25th Avenue Grade-Separation Project. This passing track option would reconstruct the raised San Carlos and Belmont Caltrain Stations and the at-grade Hillsdale and Hayward Park Stations.

As shown in Table 2-3, the average Caltrain operational service time for the Short Middle Four-Track Passing Track Option would be approximately 65.0 minutes compared to 62.2 minutes under baseline conditions and 62.5 minutes with the No Passing Track Option (Authority 2017a). Caltrain operational service times would be longer for the Short Middle Four-Track Passing Track Option than the No Passing Track Option because the passing track section is not long enough to avoid Caltrain trains needing to stop at stations to allow adequate time for the HSR trains to pass them. Average HSR operational service times for the Short Middle Four-Track Passing Track Option would be 44.7 minutes compared to 47.1 minutes with the No Passing Track Option. HSR average operational service times would be better with the Short Middle Four-Track Passing Track Option because HSR trains would be able to pass Caltrain trains between southern San Mateo and northern Redwood City.

The Short Middle Four-Track Passing Track Option would provide more track capacity between southern San Mateo and northern Redwood City, providing greater operational flexibility than the No Passing Track Option. This additional track capacity would allow the system to recover faster from delays and incidents. For example, if a train were delayed or a track were out of service along the segment between southern San Mateo and northern Redwood City, there would be greater ability to route trains around the incident and faster recovery.

The Short Middle Four-Track Passing Track Option is the shortest of the four passing track options shown in the table and would have the least impact on adjacent residential land uses. Because the 6-mile-long passing track would be grade separated prior to construction of the passing track, this option would cause the least amount of temporary construction disturbance in adjacent communities associated with track construction and roadway modifications. Further, the temporary and permanent aesthetic impacts associated with construction and operation of this passing track option would be substantially less than the other options considered.

The Short Middle Four-Track Passing Track Option is included for evaluation in this Draft EIR/EIS as part of Alternative B because it would allow for shorter HSR average operational service times (although at the expense of slower Caltrain operational service times) and because it has the potential to provide operational benefits associated with faster recovery from perturbations to railway operations. Additionally, this option would be constructed within an already grade-separated track section, thereby having less community disruption and displacements associated with expanding the existing right-of-way, as would be required with the other passing track options.

### ***Long Middle Four-Track Passing Track Option***

The Long Middle Four-Track Passing Track Option would be an approximately 8-mile passing track section from south of Ninth Avenue in San Mateo to south of State Route (SR) 84 (Woodside Road) in Redwood City (an additional 2 miles of passing track south of the Short Middle Four-Track Passing Track Option). This option would require reconstruction of the aerial San Carlos and Belmont Caltrain Stations, the at-grade Hillsdale and Hayward Park Caltrain Stations, and the Redwood City Caltrain Station, as well as additional right-of-way through downtown Redwood City.

As shown in Table 2-3, average operational service time from San Jose to San Francisco (4th and King Street Station) under this option would be approximately 60.9 minutes for Caltrain and 44.2 minutes for HSR. This option would improve Caltrain average service by 1.3 minutes compared to baseline conditions and by 1.6 minutes compared to the No Passing Track Option, and would improve HSR average operational service times by 2.9 minutes compared to the No Passing Track Option (Authority 2017a). Construction of the Long Middle Four-Track Passing Track Option would disrupt several cities and require right-of-way acquisition in San Mateo, Belmont, San Carlos, and northern and downtown Redwood City. Downtown Redwood City currently has five at-grade crossings, which would need to be reconstructed or modified to accommodate this passing track option. Temporary road closures, detours, and reduced access to property during construction at the at-grade crossings would substantially disrupt downtown Redwood City. This passing track option would have greater aesthetic impacts than the Short Middle Four-Track Passing Track Option due to additional elevated segments passing through adjacent communities.

The Long Middle Four-Track Passing Track Option is not advanced for further analysis in the Draft EIR/EIS. Although it would have average HSR operational service times similar to the Short Middle Four-Track Passing Track Option and would improve Caltrain service compared to both the baseline conditions and the No Passing Track Option, it would require more construction along a longer extent of track, resulting in greater community impacts. The limited gain to HSR and Caltrain operational service times considering the additional environmental and community impacts is the primary reason this option was withdrawn from further consideration.

### ***Long Middle Three-Track Passing Track Option***

The Long Middle Three-Track Passing Track Option would be a 16-mile section from San Mateo (south of Ninth Avenue) to north of San Antonio Avenue in Palo Alto (an additional 10 miles of passing track south of the Short Middle Four-Track Passing Track Option). This option entails one additional track in existing two-track areas and would use the existing four-track area at Redwood Junction in Redwood City. The third track would be used bidirectionally for both northbound and southbound trains, requiring precise coordination of HSR and Caltrain operations to provide for safe use of the passing track.

The Long Middle Three-Track Passing Track Option is the longest passing track option, and would extend adjacent to residential land uses for approximately half its length (8 miles). Construction of this passing track option could require reconstructing some or all of the existing 16 at-grade crossings, resulting in construction disruption in San Mateo, Belmont, San Carlos, Redwood City, Atherton, Menlo Park, and Palo Alto. The width of new right-of-way acquisition in San Mateo, Belmont and San Carlos and Redwood City would, however, be less than under the Short Middle Four-Track and Long Middle Four-Track Passing Track Options due to the three-track rather than four-track configuration.

As shown in Table 2-3, average operational service time from San Jose to San Francisco would be approximately 58.6 minutes for Caltrain and 42.7 minutes for HSR, assuming bidirectional use of the Long Middle Three-Track Passing Track Option. This option would have the shortest average operational service times for both Caltrain and HSR. Operation of this option would, however, be more challenging than the four-track options because of the need for precision dispatching, and it is possible that this option could result in slower recovery from delays or disruption events.

Although the Long Middle Three-Track Passing Track Option would result in the best Caltrain and HSR average operational service times of the options evaluated, it would require construction along the longest extent of track, resulting in more widespread community impacts. Further, the operational challenges associated with the bidirectional use of this option could be considerable. For these reasons, the Long Middle Three-Track Passing Track Option was withdrawn from further consideration.

### **Blended System Scoping (2016)**

On May 9, 2016, the Authority and FRA distributed an NOP and NOI to reinstate scoping for the Project Section EIR/EIS. The 2016 NOP/NOI rescinded the revised 2009 NOP and 2008 NOI and presented the blended system for the Project Section, which implements the strategy identified by the Authority's 2012 Business Plan and subsequent *Connecting California: 2014 Business Plan* and *Connecting and Transforming California: 2016 Business Plan* (2016 Business Plan) (Authority 2016c), and is further consistent with the *2018 Business Plan: Connecting California, Expanding Economy, Transforming Travel* (2018 Business Plan) (Authority 2018a). Public scoping activities were conducted between May 9 and July 20, 2016, and included three scoping meetings, approximately 30 meetings with business and community groups, early agency coordination, and elected official briefings.

The NOP and NOI introduced blended system alternatives proposed for study in the EIR/EIS consistent with the blended system framework and the overall project's Purpose and Need. Primary considerations when developing the alternatives included avoiding and minimizing community and environmental resource impacts and minimizing impacts on the existing passenger and freight rail systems operating within the Caltrain corridor. These considerations were balanced with the objectives of predictable and consistent travel times and consistency with Prop 1A. Based on feedback from the Peninsula communities, the mid-Peninsula station was removed from the 2016 Business Plan. The two alternatives proposed for detailed analysis in the Project Section EIR/EIS would predominantly utilize existing Caltrain track, remain substantially within the existing Caltrain right-of-way, and be designed to achieve operating speeds of up to 110 mph. A potential passing track option also was introduced. HSR stations would be at 4th and King Street Station in San Francisco, Millbrae, and San Jose Diridon.

### **Checkpoint B Light Maintenance Facility Evaluation (2016–2019)**

As part of the Checkpoint B analysis, an additional assessment of the four LMF sites considered in the 2010 SAA (Port of San Francisco, SFO, West Brisbane, and East Brisbane sites) was conducted to determine the environmental impacts that would likely result from the development of each site and to identify practicability constraints associated with the sites. This evaluation was based on the preliminary engineering designs evaluated in the 2010 SAA, which were subsequently refined during the alternatives development process for the predominantly two-track blended system. Consistent with the LMF functional criteria, the evaluation assumed that each site would be 100 acres. Table 2-4 summarizes the performance of the LMF sites evaluated relative to the siting and evaluation criteria.

The development of each of the four sites for an LMF would result in impacts on aquatic resources, with West Brisbane having the greatest impacts and East Brisbane the least. As a potentially practicable option with the least aquatic resource impacts and no impacts on listed species, the East Brisbane site is evaluated in the Draft EIR/EIS. The West Brisbane site is also evaluated in the Draft EIR/EIS. Although development of an LMF at the Port of San Francisco or SFO site would result in fewer impacts on aquatic resources than at the West Brisbane site, neither site would serve as a practicable option because of their operational constrictions and lack of availability. Because the Port and SFO options would not be practicable for an LMF, they were not advanced for consideration in the Draft EIR/EIS.

**Table 2-4 Summary of Light Maintenance Facility Sites Evaluation<sup>1</sup>**

Site Options	Performance Relative to Siting Criteria and Environmental Evaluation	Decision	
		Carried Forward	Withdrawn
Port of San Francisco	<ul style="list-style-type: none"> <li>▪ Size—100 acres</li> <li>▪ Operational considerations—stub-ended facility</li> <li>▪ Not available—site is part of San Francisco Maritime Eco-Industrial Center</li> <li>▪ Wetlands and waters impact—5.1 acres</li> <li>▪ Biological resources—no special-status species or riparian habitat.</li> <li>▪ Traffic circulation—would block road connection from Cesar Chavez Street to commercial/industrial development and would require reconstruction of a section of I-280</li> </ul>		X
West Brisbane	<ul style="list-style-type: none"> <li>▪ Size—100 acres</li> <li>▪ Operational considerations—double-ended facility</li> <li>▪ Site is available, but reduces land available for planned development (mixed use/residential permitted and commercial) at Brisbane Baylands</li> <li>▪ Wetlands and waters impact—10.2 acres</li> <li>▪ Biological resources—no special-status species or riparian habitat</li> </ul>	X	
East Brisbane	<ul style="list-style-type: none"> <li>▪ Size—100 acres</li> <li>▪ Operational considerations—double-ended facility</li> <li>▪ Site is available, but reduces land available for planned development (commercial/residential prohibited) at Brisbane Baylands</li> <li>▪ Wetlands and waters impact—1.4 acres</li> <li>▪ Biological resources—no special-status species or riparian habitat</li> </ul>	X	
SFO	<ul style="list-style-type: none"> <li>▪ Size—100 acres</li> <li>▪ Operational considerations—stub-ended facility</li> <li>▪ Not available—site is in long-term lease for critical airport-related operations.</li> <li>▪ Wetlands and waters impact—1.8 acres</li> <li>▪ Biological resources—0.6 acre of habitat for salt marsh harvest mouse, California Ridgway's rail and California black rail</li> </ul>		X

EIR = environmental impact report

EIS = environmental impact statement

I = Interstate

LMF = light maintenance facility

SFO = San Francisco International Airport

<sup>1</sup> This analysis was based on project footprints from the 2010 Supplemental Alternatives Analysis. The design of the East and West Brisbane LMF sites has been refined since 2010; therefore, the current project footprints reported in the Draft EIR/EIS have slightly different acreages and impacts on aquatic and biological resources than shown in this table.

**2.5.2.4 Alternatives Considered for the San Jose Diridon Station Approach Subsection**

The San Francisco to San Jose Project Section includes the San Jose Diridon Station Approach Subsection, which extends south from Scott Boulevard in Santa Clara to West Alma Avenue in San Jose. This subsection also forms the northern extent of the San Jose to Merced Project Section, and the alternatives development process for this subsection was conducted as part of the San Jose to Merced Project Section.

**Alternatives Development Process**

The Authority and FRA solicited input from the public and agencies through the project-level environmental review process from 2009 through 2018. Table 2-5 summarizes the alternatives development process for the San Jose Diridon Station Approach Subsection.

**Table 2-5 Alternatives Refinement Process for the San Jose Diridon Station Approach Subsection**

Process	Considerations
San Jose to Merced NEPA/CEQA Scoping (2009)	Major issues raised during scoping included alignment options and alternatives for routes, stations, and maintenance facilities, design options for grade crossing and separations, considerations for alternative elevated, trenched or tunneled alignments, parking locations, and other facilities. Additional alignment alternatives suggested for this subsection included several options for an underground tunnel or at-grade and alignment design options along SR 87, south of I-280, between the Diridon and Tamien Caltrain Stations to avoid potential impacts on the Greater Gardner neighborhood.
San Jose to Merced Preliminary and Supplemental Alternatives Analysis (2010–2011)	The San Jose to Merced PAA (Authority and FRA 2010c) and the two San Jose to Merced SAA reports (Authority and FRA 2011a, 2011b) evaluated and considered a wide range of alternatives. In this subsection, the PAA/SAA reports recommended inclusion of the SR 87/I-280 aerial alignment.
San Jose to Merced Checkpoint B Summary Report (2013)	The Authority and FRA developed a <i>Checkpoint B Summary Report</i> for the San Jose to Merced Project Section (Authority and FRA 2013) largely drawn from the work completed for the PAA and SAAs, for review by USACE and USEPA. In this subsection, the Checkpoint B Summary Report recommended inclusion of the SR 87/I-280 aerial alignment. USACE and USEPA concurred in August and September 2014, respectively, with the alternatives recommended for inclusion in the Draft EIR/EIS.
2016 Business Plan	In the 2016 Business Plan (Authority 2016c), the Authority identified certain new alternatives, including a viaduct option between San Jose and Gilroy and blended operations north of Diridon Station, and also reconsidered the formerly dismissed dedicated at-grade alignment for this subsection.
Consultation, and Alternatives Refinement (2016–2017)	The Authority and FRA conducted community outreach and engineering along the corridor in this subsection. <sup>1</sup> This additional outreach led to development of two different viaduct design options for this subsection: (1) Viaduct from West Alma Ave to I-880 and (2) Viaduct from West Alma Ave to Scott Blvd.
San Jose to Merced Checkpoint B Summary Report Addendum 3 (2017)	The Authority and FRA developed a <i>Checkpoint B Summary Report Addendum 3</i> (Authority and FRA 2017b) to review prior design options and new design options developed during 2016 and 2017. In this subsection, the Checkpoint B Summary Report recommended inclusion of the two viaduct options developed in 2016–2017 in the Draft EIR/EIS. USACE and USEPA concurred with the range of alternatives on October 20, 2017.
2018 Business Plan	In the 2018 Business Plan (Authority 2018a), the Authority considered a blended at-grade alignment for this subsection.
San Jose to Merced Checkpoint B Summary Report Addendum 4 (2018)	The Authority and FRA developed a <i>Checkpoint B Summary Report Addendum 4</i> (Authority and FRA 2018) to review the preliminary effects of the blended at-grade alternative identified in the 2018 Business Plan and assess whether to evaluate this new alternative in the Draft EIR/EIS. USACE and USEPA concurred with adding the blended at-grade alternative on January 22 and February 1, 2019 (respectively).

Authority = California High-Speed Rail Authority  
 CEQA = California Environmental Quality Act  
 EIR = environmental impact report  
 EIS = environmental impact statement  
 FRA = Federal Railroad Administration  
 I- = Interstate

NEPA = National Environmental Policy Act  
 PAA = Preliminary Alternatives Analysis  
 SAA = Supplemental Alternatives Analysis  
 SR = State Route  
 USACE = U.S. Army Corps of Engineers  
 USEPA = U.S. Environmental Protection Agency

<sup>1</sup> Outreach was conducted along the entire San Jose to Central Valley Wye corridor. The focus in this section is on the outreach between Scott Boulevard in Santa Clara and West Alma Avenue in San Jose.

## Alternatives Considered and Findings (2009–2018)

This section discusses the range of potential design options for the San Jose Diridon Station Approach Subsection that were considered by the Authority and FRA during the alternatives development process (the San Jose to Merced PAA, the two SAA reports, the 2011 “Modified Tunnel” Option Evaluation [Authority 2011b], the 2013 Checkpoint B Report, the 2017 Checkpoint B Summary Report Addendum 3, and the 2018 Checkpoint B Summary Report Addendum 4). Most of the design options are illustrated on Figure 2-27.<sup>17</sup> Table 2-6 shows the rationale for advancing alternatives into the EIR/EIS or for withdrawing alternatives and greater detail is provided in the PAA, SAAs, 2013 Checkpoint B Summary Report, 2017 San Jose to Merced Checkpoint B Summary Report Addendum 3, and 2018 San Jose to Merced Checkpoint B Summary Report Addendum 4.

The Authority and FRA screened design options for the subsection to determine which would be advanced to EIR/EIS evaluation. Two broad themes characterize design options in this subsection: (1) whether HSR would remain within the Caltrain corridor and (2) whether the HSR vertical profile would be at grade, aerial, or tunnel. Several design options generally follow the Caltrain corridor alignment: Refined Program Alignment, Three-Track, South of Caltrain Tracks, and At-Grade Alignment options, but they also include areas outside (and parallel to) Caltrain. The Blended, At-Grade option would be entirely within the Caltrain right-of-way. Other design options would not follow the Caltrain corridor south of Diridon Station (such as the SR 87/I-280 Aerial, Downtown Aerial, and Downtown Tunnel options). The second theme is vertical alignment. Many of the design options along the Caltrain corridor use extensive at-grade profile rather than aerial and tunnel options. Three design options (Viaduct to Scott Boulevard, Viaduct to I-880, and Downtown Aerial) entail aerial structures through downtown. The Blended, At-Grade option is entirely at grade through downtown. The Authority and FRA considered and evaluated several tunnel design options.

The San Jose to Merced PAA (Authority and FRA 2010c) and the two San Jose to Merced SAA reports (Authority and FRA 2011a, 2011b) evaluated and considered a wide range of alternatives including multiple tunnel options including the “Deep Tunnel”, “Shallow Tunnel”, “Thread the Needle”, and “5100-Meter Tunnel” options. In this subsection, the PAA/SAA reports recommended inclusion of the SR 87/I-280 aerial alignment and dismissed the other alternatives, including tunnel alternatives for the reasons noted in Table 2-6. A “Modified Tunnel” option, which would be at a more moderate depth than the “Deep Tunnel” option, was considered outside the PAA and SAA processes in 2011 and withdrawn due to constructability issues associated with a mined station, concerns about interaction with the future BART station, and constraints on future development (Authority 2011b).

In the San Jose to Merced 2013 Checkpoint B Summary Report, all the design options, except the SR 87/I-280 aerial option, were withdrawn from further consideration due to a variety of practicability, feasibility, and environmental effect reasons. The downtown tunnel options considered in the Checkpoint B process (Deep Tunnel and Shallow Tunnel) were withdrawn due to constructability constraints of a mined underground station and the substantially higher cost than an aerial option.

Additional modified tunnel options were evaluated leading into the San Jose to Merced Checkpoint B Summary Report Addendum 3 process as a result of community interest. An additional Blended, At-Grade option was evaluated in the 2018 San Jose to Merced Checkpoint B Summary Report Addendum 4.

---

<sup>17</sup> Three tunnel options (the “Thread the Needle”, the “5100-Meter Tunnel”, and the “Modified Tunnel” options) are not illustrated on Figure 2-27, but an alignment description is provided in the rationale for dismissal in Table 2-6.

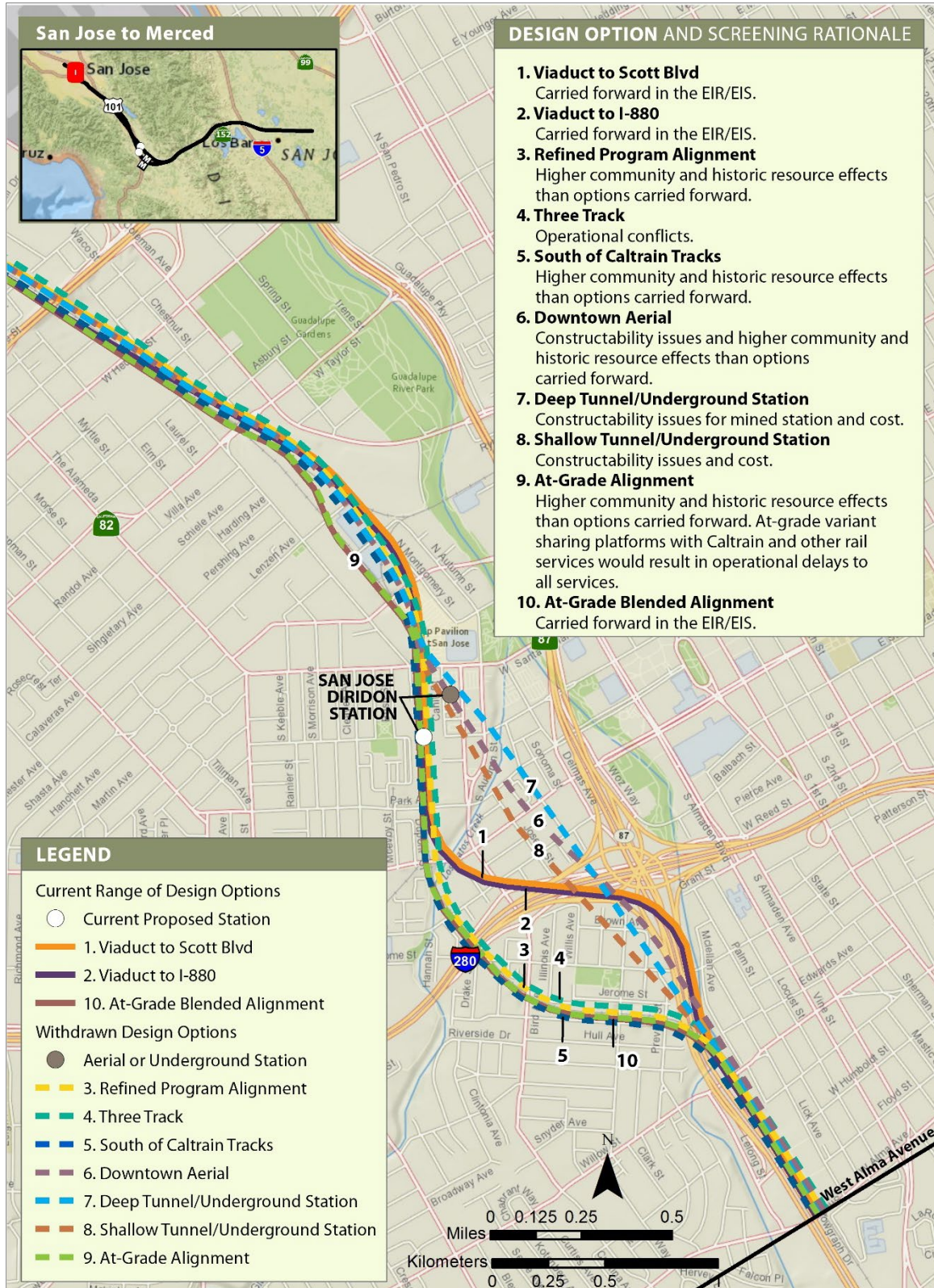

Sources: Authority and FRA 2013; Authority 2016c

MARCH 2019

**Figure 2-27 Design Options Considered in the San Jose Diridon Station Approach Subsection**



**Table 2-6 San Jose Diridon Station Approach Subsection: Design Options Considered in the San Jose to Merced Project Section Alternatives Analysis, Checkpoint, and Other Alternatives Processes**

Design Option	Description	Determination	Rationale
<b>Design options to be evaluated in detail in the Draft EIR/EIS</b>			
Viaduct to Scott Boulevard	Viaduct from south of Tamien Station to SR 87/I-280, Diridon Station arrival and departure, and then north to Scott Boulevard	To be evaluated in detail in EIR/EIS	This option is potentially practicable and is carried forward for further analysis because it meets the project's Purpose and Need; minimizes impacts by staying predominantly within existing transportation corridor rights-of-way; and does not have the logistical, feasibility, and cost issues associated with the alignment options being withdrawn.
Viaduct to I-880	Viaduct from south of Tamien Station to SR 87/I-280, Diridon Station arrival and departure, and then north to I-880 and at grade to Scott Boulevard	To be evaluated in detail in EIR/EIS	This option is potentially practicable and is carried forward for further analysis because it meets the project's Purpose and Need; minimizes impacts by staying predominantly within existing transportation corridor rights-of-way; and does not have the logistical, feasibility, and cost issues associated with the alignment options being withdrawn. This option would entail a shorter viaduct than the Viaduct to Scott Boulevard option, which would reduce visual impacts but would require other changes in construction.
Blended, At Grade	Blended, at grade from south of Tamien Station to Scott Boulevard	To be evaluated in detail in EIR/EIS	This option is potentially practicable and is carried forward for further analysis because it meets the project's Purpose and Need; minimizes impacts by staying predominantly within existing railroad rights-of-way; and does not have the logistical, feasibility, and cost issues associated with the alignment options being withdrawn. This option would entail blended at-grade operation, which would be a least-cost option.
<b>Design options withdrawn from further consideration</b>			
RPA	Aerial structure from Diridon Station to south of West Virginia St, then at-grade alignment along Caltrain corridor with two additional tracks for HSR, then to an elevated structure crossing SR 87, continuing south within the SR 87 and Caltrain right-of-way	Withdrawn in the San Jose to Merced PAA and the 2013 San Jose to Merced Checkpoint B document.	Withdrawn from further analysis because of greater impacts on historic properties than the design options being carried forward, and could also affect additional residential properties. In addition, comparatively greater significant community impacts could result from substantial noise, visual, vibration, traffic congestion and circulation, property value, and construction disruption impacts.

Design Option	Description	Determination	Rationale
Three Track	Same as the RPA option with the exception that Caltrain and UPRR would share one track through the Greater Gardner neighborhood south of Diridon Station	Withdrawn in the San Jose to Merced PAA and the 2013 San Jose to Merced Checkpoint B document.	Withdrawn from further analysis because it would be impracticable due to operational conflicts with existing rail and transit and would not meet the project's Purpose and Need.
South of Caltrain Tracks	Same as the RPA except the HSR tracks would be south of the existing Caltrain/UPRR tracks through the Greater Gardner neighborhood	Withdrawn in the San Jose to Merced PAA and the 2013 San Jose to Merced Checkpoint B document.	Withdrawn from further analysis because of substantial impacts on aesthetic/visual resources, residential displacements, and more severe impacts on historic properties than the options being carried forward.
Downtown Aerial	Aerial through downtown San Jose bypassing Diridon Station	Withdrawn in the San Jose to Merced PAA and the 2013 San Jose to Merced Checkpoint B document.	Withdrawn from further analysis because it was found to be impracticable due to major constructability issues, the comparatively high number of residential displacements, potential inconsistency with existing plans and policies, aesthetic/visual impacts, and more severe impacts on historic properties than the options being carried forward.
Deep Tunnel/ Underground Station	Tunnel through downtown San Jose and underground San Jose HSR station	Withdrawn in the San Jose to Merced PAA and the 2013 San Jose to Merced Checkpoint B document.	Withdrawn from further analysis because it was found to be impracticable as a result of geologic conditions (constructability and operational challenges of a mined underground station in an area of high groundwater); this design option would also have a capital cost approximately four times that of the option being carried forward.
Shallow Tunnel/ Underground Station	Tunnel through downtown	Withdrawn in the San Jose to Merced PAA and the 2013 San Jose to Merced Checkpoint B document.	Withdrawn from further analysis because it was determined to be impracticable due to constructability logistics and a capital cost nearly three times that of the alignment option being carried forward; further, the shallow tunnel design could result in additional cost and disruption to both existing and future heavy and commuter rail service caused by possible settlement from tunnel construction where tunnels would cross under those facilities. This design option would result in substantial biological impacts resulting from cut-and-cover activities under Los Gatos Creek.
"Thread the Needle" /Underground Station	Tunnel and aerial through downtown San Jose and underground San Jose HSR station	Withdrawn in the San Jose to Merced PAA	The "Thread the Needle" tunnel option would include an underground station, a tunnel from the station to south of I-280 and then would ascend to an aerial structure to pass over SR 87. This option would have increased travel time compared to the Deep Tunnel and would face constructability issues because of limited portal space in the SR 87/I-280 interchange.

Design Option	Description	Determination	Rationale
5100-Meter Tunnel/ Underground Station	Tunnel through downtown San Jose and underground San Jose HSR station	Withdrawn in the San Jose to Merced PAA	The “5100-Meter Tunnel” option would have a similar alignment to the “Thread the Needle” tunnel option, but would remain in tunnel until south of the Tamien Station. This option would face constructability issues associated with building a station beneath active rail lines and stations, as well as increased travel time compared to the Deep Tunnel.
Modified Tunnel/Underground Station	Tunnel through downtown San Jose and underground San Jose HSR station	Considered and withdrawn in separate 2011 process (Authority 2011b)	The “Modified Tunnel” option would be along the same alignment as the “Deep Tunnel”, but at a more moderate depth. This option was withdrawn from further analysis because it was found to be impracticable as a result of geologic conditions (constructability and operational challenges of a mined underground station in an area of high groundwater), and this design option would also have a capital cost approximately four times that of the options being carried forward.
At-Grade Alignment	Follows Caltrain corridor with additional dedicated tracks for HSR with three station variants: shared platforms with Caltrain and other services, HSR station west of Diridon platforms, HSR station east of Diridon platforms	Evaluated in 2017 and withdrawn	Withdrawn from further analysis due to substantial community disruption to neighborhoods south of downtown from at-grade alignment through North Gardner neighborhood. Sharing of platform option with Caltrain and other rail services would create substantial operational delays to all services. An HSR station east of the existing station tracks would require moving the existing historic Diridon Station structure, using extensive portions of City parking lots around the SAP Center for tracks, and require other displacements in downtown. An HSR station west of the existing station tracks would eliminate access to Caltrain’s Centralized Equipment Maintenance and Operations Facility, require relocation of the Santa Clara Valley Transportation Authority station, and require the demolition of multistory residential units west of the existing rail station.

HSR = high-speed rail  
 I- = Interstate  
 PAA = Preliminary Alternatives Analysis  
 RPA = Refined Program Alignment  
 SR = State Route  
 UPRR = Union Pacific Railroad

The Authority Board of Directors, as part of the 2016 Business Plan, directed further consideration of an at-grade alignment for the San Jose Diridon Station Approach Subsection. Authority staff evaluated an at-grade option and determined that shared use of the existing San Jose Diridon Station platforms and tracks with other passenger railroads would result in substantial delays because of insufficient capacity at Diridon Station for HSR and all other passenger rail services, unless the Caltrain Centralized Equipment Maintenance and Operations Facility (CEMOF) is relocated to allow operational use by HSR and the passenger rail services (Authority 2016d). The Authority and FRA also reaffirmed that an at-grade alignment would have substantial community impacts on the North Gardner neighborhood south of downtown, as originally identified in the San Jose to Merced PAA, SAAs, and 2013 Checkpoint B Summary Report. The Blended, At-Grade option was added in response to the Authority's 2018 Business Plan and input received from the public advocating an at-grade station at San Jose Diridon and staying within the existing railroad right-of-way. The option was evaluated in the San Jose to Merced Checkpoint B Summary Report Addendum 4 after development and consideration in 2017 and 2018.

Variations of the at-grade alignment, with exclusive HSR platforms east or west of the existing Diridon Station and platforms, were evaluated by the Authority in response to public concerns raised in 2016 and 2017 about the aesthetic and displacement impacts of an aerial design option on downtown San Jose. An HSR station east of the existing station tracks would require moving the existing historic Diridon Station, using extensive portions of City parking lots around the SAP Center for tracks, and necessitating other displacements in downtown, in addition to the community impacts on the North Gardner neighborhood. An HSR station west of the existing station tracks would eliminate access to CEMOF, require relocation of the Santa Clara Valley Transportation Authority (VTA) light rail station, necessitate the demolition of multistory residential units west of the existing station, and lead to the aforementioned impacts on the North Gardner neighborhood. In consideration of these factors, the Authority and FRA dismissed all permutations of an at-grade design option for this subsection, confirming the prior 2013 San Jose to Merced Checkpoint B Summary Report determination.

In 2016 and 2017, local community residents expressed concern about visual and noise impacts of an aerial alignment north of I-880 next to the College Park neighborhood. In response to these comments, the Authority developed a variant of the aerial design option that would entail an at-grade profile between Scott Boulevard and I-880, rather than an aerial profile. In response to the Authority's 2018 Business Plan and input received from the public about developing an at-grade station at San Jose Diridon and staying within the existing railroad right-of-way, the Authority developed and considered a Blended, At-Grade option that would use a blended alignment from the San Jose Diridon Station to the Downtown Gilroy Station. This option was subsequently evaluated in the San Jose to Merced Checkpoint B Summary Report Addendum 4.

Table 2-7 shows the design options considered for this subsection and the rationale for inclusion or withdrawal from further consideration in this Draft EIR/EIS. With elimination of the other design options, three design options for the San Jose Diridon Station Approach Subsection are evaluated in this Draft EIR/EIS: Alternative A (blended, at grade), Alternative B (Viaduct to Scott Boulevard), and Alternative B (Viaduct to I-880). These design options are described in greater detail in Section 2.6.

**Table 2-7 San Jose Diridon Station Approach Subsection: Design Options Considered for the Draft EIR/EIS**

Design Option	Decision		Reasons for Elimination (P = Primary; S = Secondary)							Environmental / Other Concerns
	Carried Forward	Withdrawn	Constructability	Cost	Community Impacts (Displacement, noise, visual, etc.)	Waters/Wetlands	Park Resources (Section 4(f))	Other Natural or Cultural Resources	Incompatibility with Other Rail	
1. Alternative B (Viaduct to Scott Boulevard)	X									Business displacement; biological, cultural, and parkland resources; visual impacts
2. Alternative B (Viaduct to I-880)	X									Business displacement; biological, cultural, and parkland resources; visual impacts
3. Refined Program Alignment		X			P	S	S	S		Community impacts: residential displacement, nonprofit (house of worship) displacement; noise; biological, cultural, visual, and park resources
4. Three Track		X			P				P	Inconsistent with Caltrain Operating Plan
5. South of Caltrain Tracks		X			P	S	S	S		Property impacts; community impacts; residential displacement; nonprofit (house of worship) displacement; noise/vibration; biological, cultural, visual, and park resources
6. Downtown Aerial		X	P		S			S		Residential/business displacement; biological, cultural, and visual resources; community concerns; constructability issues
7. Deep Tunnel/Underground Station		X	P	S				S		Major constructability issues (poor soils, high groundwater, potential settlement); business displacement; cultural resources; construction impacts; substantial costs
8. Shallow Tunnel/Underground Station		X	P	S		S		S	S	Relocation (lowering) of proposed BART station under high-speed rail station in poor soils/high groundwater; lowering of BART tunnels; impacts on Los Gatos Creek from cut-and-cover construction; business displacement; cultural resources; construction impacts; substantial costs
9. "Thread the Needle"/Underground Station		X	P	S						Increased travel time compared to the Deep Tunnel and would face constructability issues because of limited portal space in the SR 87/I-280 interchange

Design Option	Decision		Reasons for Elimination (P = Primary; S = Secondary)							Environmental / Other Concerns
	Carried Forward	Withdrawn	Constructability	Cost	Community Impacts (Displacement, noise, visual, etc.)	Waters/Wetlands	Park Resources (Section 4(f))	Other Natural or Cultural Resources	Incompatibility with Other Rail	
10. 5100-Meter Tunnel/ Underground Station		X	P	S						Constructability issues associated with building a station beneath active rail lines and stations, as well as increased travel time compared to the Deep Tunnel
11. Modified Tunnel/ Underground Station		X	P	S						Impracticable as a result of geologic conditions (constructability and operational challenges of a mined underground station in an area of high groundwater), this design option would also have a capital cost approximately four times that of the options being carried forward
12. Blended, At Grade (Alternative A)	X									Disruption and noise impacts; biological, cultural, and parkland resources

BART = Bay Area Rapid Transit  
 I- = Interstate  
 SR = State Route

## 2.6 Alignments, Station Sites, and Maintenance Facilities Evaluated in this Draft EIR/EIS

This section describes the No Project Alternative and the two end-to-end project alternatives.

### 2.6.1 No Project Alternative—Planned Improvements

NEPA requires the evaluation of a “no action” alternative in an EIS (CEQ Regulations § 1502.14(d)). Similarly, CEQA requires that an EIR include the evaluation of a “no project” alternative (CEQA Guidelines § 15126.6(e)). The No Project Alternative (synonymous with the NEPA No Action Alternative) considers the impacts of conditions forecast by current plans for land use and transportation in the vicinity of the Project Section, including planned improvements to the highway, aviation, conventional passenger rail, freight rail, and port systems through the 2040 planning horizon for the environmental analysis if the proposed project is not built. Under the No Project Alternative, the Caltrain PCEP would be built and DTX would extend existing Caltrain commuter service to the Salesforce Transit Center (SFTC).

#### 2.6.1.1 Projections Used in Planning

The Project Section would travel through San Francisco, San Mateo, and Santa Clara Counties, where population is projected to increase between 2015 and 2040 by about 20 percent, 15 percent, and 22 percent, respectively (Table 2-8). As shown in the table, most of the region’s job growth would concentrate in San Francisco and Santa Clara Counties, consistent with the region’s current spatial distribution of jobs. The projections show that San Mateo County employment would grow at the lowest rate of the three counties, adding about 91,400 projected new jobs between 2015 and 2040. San Francisco and Santa Clara Counties would add approximately 155,300 and 241,300 net new jobs, respectively. The region overall is expected to experience an annual average job growth rate that is slightly lower than the statewide average over the next 25 years.

**Table 2-8 Regional Projected Population and Employment, 2015 and 2040**

	2015	2040 Projections	Percent Change
<b>Population</b>			
State of California	38,907,642	47,233,240	21.4
San Francisco City/County	857,508	1,027,004	19.8
San Mateo County	759,155	874,626	15.2
Santa Clara County	1,903,974	2,331,887	22.5
<b>Regional Total</b>	<b>3,520,637</b>	<b>4,233,517</b>	<b>20.2</b>
<b>Employment</b>			
State of California	16,474,800	20,895,900	26.8
San Francisco City/County	668,900	824,200	23.2
San Mateo County	384,100	475,500	23.8
Santa Clara County	1,032,200	1,273,500	23.4
<b>Regional Total</b>	<b>2,085,200</b>	<b>2,573,200</b>	<b>23.4</b>

Sources: CDOF 2014, 2016; CEDD 2016; Caltrans 2015

### 2.6.1.2 **Planned Land Use**

The evaluation of the No Project Alternative considers planned transportation, housing, commercial, and other development projects through the planning horizon year 2040. Volume 2, Appendix 3.18-A, Cumulative Nontransportation Plans and Projects List, and Appendix 3.18-B, Cumulative Transportation Plans and Projects Lists, describe foreseeable future development projects—shopping centers, large residential developments, and planned transportation projects defined in the various regional transportation plans (RTP) for each of the three counties. The following discussion focuses on the larger projects in the three counties along the Project Section during the 25-year planning horizon from 2015 to 2040.

The land use plans for San Francisco, San Mateo, and Santa Clara Counties encourage infill and higher-density development in urban areas and concentration of uses around transit corridors to accommodate the projected regional population growth through 2040. Thus, many of the planned and other reasonably foreseeable future residential or mixed-use projects propose infill development. The Bay Area's RTP—*Plan Bay Area 2040* (ABAG and MTC 2017)—further this goal by encouraging compact development and a greater investment in local transit modes.

Planned land uses in the San Francisco to South San Francisco Subsection in the City and County of San Francisco include the recently adopted Central South of Market (SoMa) Plan, which would allow an additional 8,800 housing units in the existing high-density urban environment around the 4th and King Street Station (City and County of San Francisco 2018). This increased density would be complemented by transportation improvements, such as the Central Subway Project (anticipated completion of construction in 2020 and start of revenue service in 2021), which will extend the San Francisco Municipal Railway (MUNI) Metro T Third Line through SoMa, Union Square, and Chinatown. The Schlage Lock project currently under construction in Visitacion Valley will develop 1,679 residential units and 46,700 square feet of retail on a site near the existing Bayshore Caltrain Station. In November 2018, the City of Brisbane and the city's voters approved a General Plan Amendment that allows up to 2,200 dwelling units, 6.5 million square feet of new commercial development, and up to 500,000 square feet of hotel development in the Brisbane Baylands area.<sup>18</sup>

In the San Bruno to San Mateo Subsection, the City of Millbrae has adopted zoning and specific plans that affect and shape development in the Millbrae Station vicinity. The Millbrae Station Area Specific Plan proposes higher-density mixed-use residential and commercial uses in the areas closest to the Millbrae Station, including at the location of the current BART parking lots, to take advantage of station proximity and connect the station to adjacent neighborhoods and the downtown area. Development applications have been submitted for two projects on these sites—the Millbrae Serra Station Project and the Gateway at Millbrae Station. The Millbrae Serra Station Project would be a 3.53-acre mixed-use TOD combining residential, office, retail, and public parking uses west of the Millbrae Station along Serra Avenue and El Camino Real. The project would include 444 multifamily residential units, 290,100 square feet of office, and 13,200 square feet of retail in three buildings. The Gateway at Millbrae Station would be on an 11-acre BART-owned site immediately east of the Millbrae Station, and would include office, retail, market-rate and affordable multifamily residential apartments, and hotel uses. The project would consist of 400 residential units, 151,583 square feet of office, 44,123 square feet of retail, and a 164-room hotel.

Planned land uses in the San Mateo to Palo Alto Subsection include mixed-use development, office space, commercial and retail development, and residential buildings. In San Mateo, development near the Hillsdale and Hayward Park Caltrain Stations is guided by the *San Mateo Rail Corridor Transit Oriented Development Plan* and the *Hillsdale Station Area Plan*. Mixed-use development, commercial development projects, and a 96-room hotel are under construction in Belmont, while the 6.26-acre mixed-use San Carlos Transit Village and associated San Carlos Multi-Modal Transit Center Project are under construction near the San Carlos Station. Planned

---

<sup>18</sup> A revised Specific Plan is under preparation to reflect the approved General Plan Amendment. As a decision on a Specific Plan is still pending, it has not been included in the analysis under the No Project Alternative in this Draft EIR/EIS.



development projects in Redwood City, Menlo Park, and Palo Alto consist of mixed-use development, senior housing, residential, office, commercial, and hotel uses; many of these planned projects are along El Camino Real.

In the Mountain View to Santa Clara Subsection, proposed development in Mountain View includes a new 28.7-acre LinkedIn corporate campus along Middlefield Road and other multifamily housing, office space, community and hotel facilities, and mixed-use developments. Approved projects in Sunnyvale include a 36-acre mixed-use project (CityLine Sunnyvale [formerly Town Center]) and a 47-acre office campus project (Moffett Towers II). One of the region's largest development projects—the 240-acre (9.2 million gross square feet) CityPlace mixed-use development near Levi Stadium—was approved in Santa Clara. Mixed-use development plans for the area surrounding the Lawrence Caltrain Station in Santa Clara are guided by the Lawrence Station Area Plan.

Planned projects in the San Jose Diridon Station Approach Subsection in San Jose include medical office, hotel, residential, and mixed-use development; an outdoor performing arts pavilion; an office/data center; a proposed professional baseball stadium with a maximum seating capacity of 36,000 in the Diridon Station area; and shopping center expansion. The City of San Jose agreed to enter into an exclusive negotiating agreement with Google for 16 city-owned parcels. Google is proposing a downtown campus with 6 million to 8 million square feet of tech office and research and development on 240 acres; additional amenities would include open space, entertainment, and retail with housing summarized in the Diridon Station Area Plan. North of Diridon Station, a seven-story mixed-use development is proposed on Stockton Avenue. Other pending development projects include 785–807 Alameda, City Place Project in Santa Clara, and the VTA Transit-Oriented Joint Development at the San Jose, Santa Clara, and Tamien Stations. An underground parking garage is proposed under the historic San Jose Waterworks east of Diridon Station on West Santa Clara Street, a four- to five-story mixed-use development is planned at the intersection of Delmas and Park Avenues, and 120 condominiums are proposed for Delmas Avenue between West San Carlos Street and Auzerais Avenue, south of the station. A substantial amount of development is proposed east and north of the junction of SR 87 and I-280 as well as south of I-280.

### **2.6.1.3 Planned Highway Improvements**

The highway and roadway component of the No Project Alternative includes the planned efforts of the California Department of Transportation (Caltrans) and the three counties through which the Project Section passes (San Francisco, San Mateo, and Santa Clara) to address the anticipated growth in vehicle miles traveled and resulting congestion on the roadway system. Analysis of the No Project Alternative considers the funded and programmed improvements on the intercity highway and roadway network based on financially constrained RTPs developed by regional transportation planning agencies. Many of the planned highway improvements are directly related to Caltrans' plans for the improvement of US 101, the primary north-south highway in the corridor and a major state priority. Other planned highway improvements would be undertaken by Caltrans on other regional highways, including SR 237, SR 85, SR 92, I-280, I-680 and I-880. SR 237 express lanes and Central, Montague, and San Tomas Expressway improvements are planned in Santa Clara County. The improvements in Santa Clara County primarily entail construction of an express lane network on the highway system—individual interchange upgrades, conversion of high-occupancy vehicle (HOV) lanes to express lanes, and construction of new express lanes (Table 2-9). These improvements would not cumulatively add substantial capacity to the existing highway system, but they would provide enhanced efficiency of existing highways.

**Table 2-9 Planned Highway Improvements—No Project Alternative**

Project Name	Type of Project
<b>City/County of San Francisco</b>	
Harney Way widening	Reconstruct and widen Harney Way to 8 lanes to accommodate the additional BRT and auto lanes and improve bicycle lanes and sidewalks
Geneva Avenue extension—Bayshore Blvd to US 101	Extension of Geneva Avenue from its current terminus at Bayshore Boulevard to Harney Way with a new interchange at US 101
<b>County of San Mateo</b>	
Improve SR 92 from San Mateo Bridge to I-280	Widen SR 92 and add an uphill passing lane from US 101 to I-280
US 101 auxiliary lanes from Sierra Point to SF County Line	Construction of auxiliary lanes
Reconstruct US 101/Sierra Point Pkwy interchange (includes extension of Lagoon Way to US 101)	Interchange reconstruction and road extension
US 101 express lane conversion from San Mateo/Santa Clara County line to Whipple Ave	Conversion of HOV lanes to express lanes
US 101 widening, Whipple Ave to Millbrae	Road widening to add an express lane in each direction
US 101 auxiliary lanes, Marsh Rd to Embarcadero Rd	Construction of auxiliary lanes (one in each direction)
US 101 auxiliary lanes, San Bruno Ave to Grand Ave	Construction of auxiliary lanes (one in each direction)
<b>City of Brisbane</b>	
US 101/Candlestick Point interchange project	Interchange reconfiguration
<b>City of South San Francisco</b>	
US 101 ramp improvements project	Ramp improvements
US 101/Produce Ave interchange	Construct a local interchange on US 101 from Utah Ave on the east to the vicinity of Produce Ave on the west
<b>City of Millbrae</b>	
US 101 Millbrae Ave bike/pedestrian bridge	Construction of new 10-foot-wide Class 1 bike/pedestrian overcrossing across US 101 north of and adjacent to the existing Millbrae Ave bridge
<b>City of Burlingame</b>	
US 101/Broadway interchange reconstruction project	Interchange reconfiguration; bridge replacement and widening
<b>City of San Mateo</b>	
US 101/Peninsula Ave interchange	Addition of ramps for southbound US 101 at Peninsula and closure of ramps at Poplar
Poplar/US 101 traffic safety improvements	Construction of median island and traffic calming improvements
SR 92/El Camino Real ramp modifications	Interchange improvements and modifications to existing ramps

Project Name	Type of Project
<b>City of San Carlos</b>	
US 101/Holly St interchange modification project	Interchange modification. Widen eastbound to northbound ramp to two lanes and eliminate northbound to westbound loop
US 101/Holly St pedestrian overcrossing	Pedestrian improvements
<b>City of Redwood City</b>	
US 101/Woodside interchange	Reconstruct and reconfigure interchange
<b>City of Menlo Park</b>	
US 101/Willow Rd interchange reconstruction	Interchange improvements
<b>City of Palo Alto</b>	
Adobe Creek/US 101 bicycle/pedestrian bridge	New bicycle/pedestrian overcrossing across US 101 at Adobe Creek
Dumbarton Bridge to US 101 connection study	Transportation study
<b>City of Sunnyvale</b>	
SR 237/US 101/Mathilda interchange modifications	Modify US 101/Mathilda and SR 237/Mathilda interchanges to relieve congestion and improve local circulation
<b>Santa Clara County/San Jose</b>	
Central Expy widening and auxiliary lanes, Lawrence Expy to Mary Ave	Road widening to provide auxiliary lanes
Central Expressway widening from 4 to 6 Lanes, Lawrence Expy to San Tomas Expy	Road widening
Construct interchange at Lawrence Expy and Arques Ave	New interchange
Construct local roadway improvements overcrossing US 101 (includes local circulation improvements to Zanker Rd, Old Bayshore Hwy, North 4th St and Skyport Dr)	Highway overcrossing improvements
HOV lane conversion to general purpose lane, Central Expressway between San Tomas and De La Cruz	Lane conversion
I-880/I-280/Stevens Creek Blvd interchange improvements	Interchange and off-ramp reconfiguration
Improve intersection at Lawrence Expy and Prospect Rd by adding a second left-turn lane and modifying the existing traffic signals	Intersection reconfiguration
Improve SR 237 westbound to SR 85 southbound connector ramp widening and improvements and southbound auxiliary lane construction, SR 237 to SR 85/El Camino Real interchange	Ramp improvements and auxiliary lane construction
Mary Avenue extension across SR 237	Road extension and interchange reconfiguration
Realign Wildwood Ave to connect with Lawrence Expy	Road reconfiguration
San Tomas Expy widening to 8 Lanes, El Camino Real (SR 82) to Williams Rd	Road widening
Santa Clara County—US 101 express lanes, Great America Pkwy to Lawrence Expy	Conversion of HOV lane to express lane and addition of express lane and SB auxiliary lanes

Project Name	Type of Project
SR 237 express lane conversion, I-880 to Mathilda Ave	Conversion of HOV lanes to express lanes
SR 237 express lanes: Mathilda Ave to SR 85	Construction of new HOV/express lanes
SR 237 express lanes: Zanker Rd to Mathilda Ave	Implement roadway pricing on SR 237 carpool lane
SR 237 westbound to northbound US 101 on-ramp widening and auxiliary lane	On-ramp widening and auxiliary lane construction
SR 85 express lane conversion, US 101 in Mountain View to US 101 in South San Jose	Conversion of HOV lanes to express lanes
SR 85 express lanes and auxiliary lane, I-280 to SR 87	Express lane and auxiliary lane construction
SR 85 northbound to SR 237 eastbound connector ramp improvements and eastbound SR 237 auxiliary lane construction, SR 85 to Middlefield Rd	Ramp improvements and auxiliary lane construction
US 101/Capitol Expy interchange improvements	Interchange modification and new on-ramp construction
US 101/Montague Expy interchange	New interchange construction
Widen Montague Expy to 8 lanes between Trade Zone Blvd and I-680 and to 6 lanes between I-680 and Park Victoria Dr for HOV lanes	Road widening and HOV lane construction
SR 87 HOV conversion, SR 85 to US 101	Conversion of HOV lanes to express lanes with interchange modifications
US 101 express lane conversion, San Mateo/ Santa Clara County Line to SR 25	Conversion of HOV lanes to express lanes and construction of express lanes with interchange modifications
I-280 express lanes, Leland Ave to US 101	Conversion of HOV lanes to express lanes and construction of express lanes with interchange modifications
I-680 express lanes, Alameda County line to US 101	Conversion of HOV lanes to express lanes and construction of express lanes with interchange modifications
I-880 express lanes, Alameda County line to US 101	Conversion of HOV lanes to express lanes and construction of express lanes with interchange modifications
Widen Coleman Ave from 4 to 6 lanes from I-880 to Taylor St	Road widening
Diridon Area parking and multimodal improvements	Parking and transit improvements
Autumn St widening and extension, UPRR tracks to San Carlos St	Road widening, partial realignment, and extension
Park Ave multimodal streetscape project (partially completed)	Pedestrian and bicycle improvements
St. John St multimodal improvements—Phase 1 (SAP Center to North First St)	Pedestrian and bicycle improvements

BRT = bus rapid transit  
 HOV = high-occupancy vehicle  
 I = interstate  
 SR = State Route  
 UPRR = Union Pacific Railroad  
 US = U.S. Highway

### 2.6.1.4 **Planned Aviation Improvements**

SFO and Norman Y. Mineta San Jose International Airport (SJC) are the large- and medium-hub commercial service airports that serve the cities and counties near the Project Section. One federal airport—Moffett Federal Airfield—is off US 101 in Mountain View. Two general aviation airports are also near the corridor—San Carlos Airport and Palo Alto Airport.

#### **San Francisco International Airport**

Improvement plans for SFO are documented in the 1992 San Francisco Airport Master Plan. For SFO, the Final Noise Exposure Map Report provides updated forecasts from the 1992 San Francisco Airport Master Plan, projecting 37.4 million passengers by 2033. The master plan identifies planned improvements, including the replacement of Boarding Area B in Terminal 1, renovation of Boarding Area C in Terminal 1, and consolidation of cargo facilities in the North and West Field areas to accommodate these additional passengers. The 2012 *Comprehensive Airport Land Use Compatibility Plan for the Environs of San Francisco International Airport* includes an updated Future Airport Layout Plan that reflects planned enhancements to runway safety areas to comply with Federal Aviation Administration standards (City/County Association of Governments of San Mateo County 2012). In addition, the draft *San Francisco International Airport Development Plan* from 2016 details recommended projects for improvements in several areas throughout the airport (City and County of San Francisco 2016).

#### **San Carlos Airport**

San Carlos Airport is a public airport in San Mateo County, owned and operated by the county, that accommodates 400 based aircraft (City/County Association of Governments of San Mateo County 2015). The *Comprehensive Airport Land Use Compatibility Plan for the Environs of San Carlos Airport* identifies no major planned improvements.

#### **Moffett Federal Airfield**

Improvements to Moffett Federal Airfield are documented in the 2016 *Comprehensive Land Use Plan Santa Clara County Moffett Federal Airfield* (County of Santa Clara 2016a). It indicates that there are no planned aviation improvements at Moffett Federal Airfield.

#### **Palo Alto Airport**

Palo Alto Airport is a public airport in Santa Clara County. Improvements are documented in the 2008 *Comprehensive Land Use Plan Santa Clara County Palo Alto Airport*, which was updated in 2016. Future airport facilities include a potential of 29 aircraft hangars, new helipad, general aviation terminal building and parking lot, and reconfiguration of a taxiway (County of Santa Clara 2016b).

#### **Norman Y. Mineta San Jose International Airport**

SJC is served by 12 commercial airlines with approximately 130 daily departures to 30 nonstop destinations. In November 2005, the San Jose City Council approved a comprehensive plan for replacing and upgrading the terminal facilities at SJC. The Terminal Area Improvement Program was planned in two phases. Phase 1 was completed in 2010. Phase 2, expansion to add 10 more aircraft gates, would begin when the airport reaches specific levels of passenger activity or flights in the future (City of San Jose Airport Department 2018).

The first phase of the Terminal Area Improvement Program included the comprehensive modernization of the airport. Elements included a new Terminal B and Concourse, upgrades for Terminal A, expanded restaurant and retail concessions, expanded roadway capacity, an on-site consolidated rental car center and public parking garage, and public art. Construction of Terminal B and the new Terminal B Concourse began in 2004 as the first major element of the new airport facilities. Located between Terminal A and Terminal B, the new concourse has 12 aircraft gates, waiting lounges, and new shops and restaurants. Southwest Airlines activated the first six gates in the new concourse for interim service in July 2009. The remainder of the concourse opened with completion of Terminal B facilities in June 2010.

Phase 2 includes the second half of Terminal B with a South Concourse mirroring the North Concourse, adding 10 new aircraft gates. This addition would bring the total number of gates to the 40 allowed under the 2018 Airport Master Plan to serve 17 million annual passengers (City of San Jose Airport Department 2018).

### **2.6.1.5 Planned Intercity Transit Improvements**

The 2040 No Project Alternative transit service levels include all planned bus and rail service upgrades to accommodate regional growth, including the Caltrain Modernization Program, BART and MUNI extensions, and new or expanded bus facilities. These services have been planned assuming the potential for future feed into HSR, but they would provide increased transit service levels without the introduction of HSR.

#### **Conventional Passenger Rail**

Caltrain, BART, MUNI, Altamont Corridor Express (ACE), Amtrak, and VTA provide existing passenger train services in the project vicinity. Caltrain provides passenger rail service on the San Francisco Peninsula between San Francisco and downtown San Jose with stops in San Mateo County and Santa Clara County. Caltrain is operated under the jurisdiction of the PCJPB and is managed by San Mateo County Transit District (SamTrans). The Caltrain system includes 77 miles of track and has 39 at-grade crossings between San Francisco and Santa Clara and 32 at-grade crossings between San Jose and Gilroy. As of 2018, Caltrain operates 92 weekday trains, including Baby Bullets (express), limited, and local services. The average weekday Caltrain ridership in 2018 was approximately 65,100; of this, approximately 97 percent (63,170 riders) traveled between San Francisco and San Jose, including approximately 15,420 riders at the 4th and King Street Station and 3,340 riders at the Millbrae Station (Caltrain 2018).

In January 2015, the PCJPB certified and adopted the PCEP EIR (PCJPB 2015) as part of the program to convert operation of the Caltrain rail corridor between San Jose and San Francisco to EMU cars. The approximately 51-mile project will include the installation of electrification infrastructure including TPFs, poles and OCS, and EMU trains. The existing diesel locomotive-hauled fleet will be replaced with EMU trains to facilitate the blended Caltrain and HSR system. The project is anticipated to be completed in 2022. The delivery of the PCEP constitutes an “early investment” in the future shared operation of Caltrain and HSR in the corridor in a blended system that offers both intercity HSR and regional commuter rail service. Prior to HSR’s anticipated arrival, additional system upgrades will be made, including new stations at San Jose, Millbrae, and San Francisco. In addition, the rail tracks from the 4th and King Street Station will be extended to the new SFTC in downtown San Francisco. Known as the DTX, the project is currently only partially funded.

BART provides passenger rail transit service to downtown San Francisco to and from cities in the northern portion of the San Francisco Peninsula, Oakland, Berkeley, Fremont, Walnut Creek, Dublin/Pleasanton, and other cities in the East Bay. The BART system comprises five lines and 45 stations. The average weekday ridership for fiscal year 2016 was approximately 431,000 (BART 2018). The only proposed HSR stations that would have a direct connection to BART are the Millbrae Station, which serves the Richmond and Antioch BART lines, and the San Jose Diridon Station, which will serve the Warm Springs/South Fremont line upon completion of the BART Silicon Valley Phase 2 Extension from Berryessa/North San Jose through downtown San Jose to Santa Clara.

MUNI, which is operated by the San Francisco Municipal Transportation Agency, provides various transit services within San Francisco. The MUNI Metro system, a mixture of above- and below-ground light rail service, consists of nine routes serving residential areas and the financial district.

Amtrak provides intercity passenger rail service in California on four principal corridors covering more than 1,300 linear route miles and spanning most of the state. The existing passenger rail network in the Project Section includes portions of two corridors: the Coast Starlight follows the UPRR coast route between San Jose and Gilroy; and the Capitol Corridor, which terminates in San Jose, provides service north to Oakland and eventually to Sacramento and Auburn.

ACE provides four daily round-trip trains from Stockton to San Jose Diridon Station via Tracy and Livermore, with intermediate stops. ACE is working with the Authority to study an enhanced regional rail service between Stockton, Modesto, and San Jose and plans to expand service to six round trips in the short term and 10 round trips in the long term.

VTA provides bus, light rail and paratransit within Santa Clara County. VTA operates a light rail system (Line 901, the Alum Rock—Santa Teresa line) serving San Jose and surrounding suburban areas south and east of Diridon Station.

The No Project Alternative includes passenger rail system improvements identified in the State Transportation Improvement Program and Caltrans’ California State Rail Plan for implementation before 2040 (Caltrans 2013). Table 2-10 shows these improvements, in addition to other passenger rail improvements identified by Caltrain, BART, MUNI, and Capitol Corridor.

**Table 2-10 Planned Passenger Rail Projects—No Project Alternative**

Jurisdiction	Project Name	Type of Project
City and County of San Francisco, San Mateo and Santa Clara Counties	Caltrain Peninsula Corridor Electrification Project	Installation of electrification infrastructure (traction power facilities, poles and OCS, and EMUs) along 51 miles of the Caltrain corridor between San Francisco and San Jose. An upgraded signal system will increase operational safety and establish PTC; the existing diesel locomotive-hauled fleet will be replaced with EMUs to facilitate the blended system.
City and County of San Francisco	Downtown Rail Extension	Extension of Caltrain commuter rail from its current terminus at 4th and King Streets to the new Salesforce Transit Center.
City and County of San Francisco	Central Subway Project	Extension of the MUNI Metro T Third Line through SoMa, Union Square, and Chinatown will provide a direct rapid transit link between downtown and the existing T Third Line route on 3rd Street. When the Central Subway is completed, T Third Line trains will travel mostly underground along a 1.7-mile alignment from the 4th and King Street Station to Chinatown.
City and County of San Francisco	T-Line Extension	Extension of MUNI Metro T Line to relocated Bayshore Caltrain Station in proximity to future Geneva BRT terminus.
County of Santa Clara	BART to Silicon Valley Project	A 16-mile extension from Warm Springs Station in Fremont to Santa Clara. Phase I, the Berryessa Extension Project, would connect Warm Springs to new stations in Milpitas and Berryessa; Phase II would connect Berryessa Station to new stations in Alum Rock, downtown San Jose, San Jose Diridon Station, and Santa Clara.
County of Santa Clara	Capitol Expressway LRT Extension Phase 2	The VTA Capitol Expressway Transit Improvement Project would transform Capitol Expressway into a multimodal boulevard offering BRT, LRT, and safe connections to the regional transit system.

Jurisdiction	Project Name	Type of Project
County of Santa Clara	LRT Extension Winchester Station to Vasona Junction	A 1.6-mile extension of the existing Mountain View to Winchester line from the Winchester Station in Campbell to Los Gatos. The project would be implemented in two phases based on funding and projected ridership. Phase 1 would include construction of a double set of light rail tracks at the existing Winchester Station, expansion of parking capacity at the Winchester Station, construction of a new Vasona Junction Station with a Park & Ride lot and end-of-the-line facilities, and lengthening of six existing station platforms along the Vasona Corridor alignment (Winchester, Campbell, Hamilton, Bascom, Fruitdale, and Race) to accommodate longer trains. Phase 2 would consist of construction of a new Hacienda Light Rail Station with an optional Park & Ride lot.
City of San Jose	Mineta San Jose International Airport People Mover	Dedicated guideway connection from the Norman Y. Mineta San Jose International Airport to the Caltrain, BRT, and future BART stations at the Santa Clara Transit Center and the VTA LRT on North First Street.
County of Alameda and County of Santa Clara	Capitol Corridor Joint Powers Authority Oakland to San Jose Phase 2 Double Track	Construct a second mainline track, platforms and modifications to existing tracks between the cities of Oakland and San Jose, on the Union Pacific Railroad.
Counties of Monterey, San Benito, and Santa Clara	Monterey County Rail Extension	Extension of passenger rail service from Santa Clara County south to Salinas with two daily round trips initially and up to six daily round trips at buildout between San Jose and Salinas. Kick-start phase includes a downsized Salinas Station, track improvements in Gilroy to allow through-service and minor station improvements in Morgan Hill, Gilroy, and Tamien Stations.

BART = Bay Area Rapid Transit  
 BRT = bus rapid transit  
 EMU = electrical multiple units  
 LRT = light rail transit  
 MUNI = San Francisco Municipal Railway  
 OCS = overhead contact system  
 PTC = positive train control  
 SoMa = South of Market  
 VTA = Santa Clara Valley Transportation Authority



### Passenger Bus Service

The No Project Alternative would include implementation of bus transit projects identified and funded in *Plan Bay Area 2040* (ABAG and MTC 2017). These projects include new or enhanced bus facilities to expand transit capacity and performance in the Project Section (Table 2-11). These improvements would primarily affect the 4th and King Street Station.

**Table 2-11 Planned Passenger Bus Improvements—No Project Alternative**

Jurisdiction	Project Name	Type of Project
City and County of San Francisco	16th Street Improvement Project	Improve transit reliability and travel time along 2.3 miles of 16th Street by providing transit-only median lanes, transit bulbs, new traffic and pedestrian signals, and streetscape amenities. The project will allow for zero-emission transit service into Mission Bay by extending the OCS that powers trolley buses from Kansas Street to 3rd Street.
City and County of San Francisco	Van Ness BRT Project	Provide dedicated bus lanes along 2 miles of Van Ness and South Van Ness Avenues from Lombard to Mission Streets. The project will also provide for low-floor boarding, high-quality shelters, pedestrian safety enhancements, and transit signal priority.
City and County of San Francisco	Geary BRT Project	Provide dedicated transit lanes, utility upgrades, and streetscape improvements from Stanyan Street to Market Street.
City and County of San Francisco	Geneva-Harney BRT Project	Extend Geneva Avenue from Brisbane to Candlestick Point and institute BRT service, including relocation of the Bayshore Caltrain Station to just north of the Geneva BRT terminus.
County of San Mateo	SamTrans El Camino Real Express Rapid Bus Project	Complements El Camino Real bus service by providing additional rapid bus service during commute periods between the Daly City BART station and the Redwood City Transit Center. Interim stops are located at the Colma, South San Francisco, San Bruno, and Millbrae BART Stations as well as the Hillsdale, Belmont, and San Carlos Caltrain Stations.
County of Santa Clara	El Camino Real BRT improvements	Upgrade the 522 Rapid Bus Route on El Camino Real to BRT status through roadway modifications, upgrade existing stations to more substantial, rail-like stations, and install bicycle lanes on El Camino Real in areas where there are dedicated BRT lanes.
County of Santa Clara	Stevens Creek Corridor BRT improvements	Provision of BRT service, in addition to the existing local route, for 8.5 miles from De Anza College to the Transit Mall in downtown San Jose using San Carlos Avenue and Stevens Creek Boulevard.

BART = Bay Area Rapid Transit  
 BRT = bus rapid transit  
 OCS = overhead contact system  
 SamTrans = San Mateo County Transit District

### 2.6.1.6 Planned Freight Rail Improvements

Two Class 1 freight railroads operate in the Bay Area—UPRR and BNSF Railway (BNSF). Freight flow by rail accounted for 3 percent of tonnage and 2 percent of value moved in the Bay Area in 2012. Between San Francisco and San Jose, freight trains operate daily along the Caltrain corridor, making up less than 5 percent of train traffic on the Peninsula (MTC 2016). Both BNSF and UPRR currently operate near capacity within the Caltrain corridor. According to the *San Francisco Bay Area Goods Movement Plan* (MTC 2016), without major improvements (e.g., double tracking more sections), freight activity would exceed capacity by 2020, with minimal additional train movements. UPRR and BNSF have historically added capacity when needed to meet market demands in other regions. Future improvements are expected to continue to provide sufficient capacity for interstate needs.

Development projects to accommodate projected population growth and economic growth, including shopping centers, industrial parks, transportation projects, and residential developments, would continue under the No Project Alternative and could result in increased demands for transport of freight by rail and the resulting need to expand freight services. Freight levels depend on not only the overall level of economic activity but also the specific demand for bulk and oversize commodities that dominate freight carried by rail. Freight rail traffic in the Caltrain corridor is expected to increase at a rate of 3.5 percent per annum (Caltrans 2014). This rate is an informal rate that freight operators, such as UPRR, often cite. Table 2-12 shows existing and assumed future freight levels along different parts of the Project Section under the No Project Alternative.

**Table 2-12 Existing and Assumed Future Freight Train Operations—No Project Alternative**

Year	Total Daily Number of Trains (Both Directions) Per Segment				
	San Francisco to South San Francisco	South San Francisco to Redwood City	Redwood City to Santa Clara	Santa Clara to Diridon	Diridon to Gilroy
2016	2	4	2	9	4
2040 <sup>1</sup>	5	10	5	10	23

Source: Caltrans 2014

<sup>1</sup> Growth factor of 3.5 percent rounded up conservatively to 4 percent per annum change every year starting in 2017.

### 2.6.1.7 Planned Port Improvements

Ports in the region can influence goods movement and regional circulation. The primary port in the project vicinity is the Port of San Francisco. Cruise ships, ferries, and cargo ships dock at the various piers in the San Francisco Bay. Ferry service is operated by the Golden Gate Ferry service and by the San Francisco Bay Area Water Emergency Transportation Authority (WETA). Golden Gate Ferry provides service between the San Francisco Ferry Building, Larkspur, Sausalito, and Tiburon, with limited service to Oracle Park (formerly AT&T Park). There were approximately 8,500 estimated daily riders on weekdays (as of 2018) on the Golden Gate Ferry system (Golden Gate Bridge, Highway, and Transit District 2019). The San Francisco Bay Area Water Emergency Transportation Authority provides service under the San Francisco Bay Ferry brand between San Francisco Pier 41, the Ferry Building, Oracle Park (formerly AT&T Park), Chase Center, and South Francisco to locations across the bay such as Mare Island, Vallejo, Richmond, Alameda, Oakland, and Harbor Bay. There were approximately 10,000 estimated daily riders (as of 2016) of the San Francisco Bay Ferry system (WETA 2016).

The *Port of San Francisco Strategic Plan 2016–2021* and the *San Francisco Bay Area Water Emergency Transportation Authority Strategic Plan 2016* aim to expand cargo and ferry service in the Bay Area (Port of San Francisco 2016; WETA 2016). Under this expanded service, estimated daily riders are projected to increase to 40,760, new ferry terminals would be built (one in Redwood City), and existing ferry terminals (such as the Downtown San Francisco Ferry Terminal) would be expanded. Table 2-13 shows the planned port projects near the Project Section.

**Table 2-13 Planned Port Improvements—No Project Alternative**

Jurisdiction	Project Name	Type of Project
City and County of San Francisco	Port of San Francisco Downtown Ferry Terminal Improvements	Transit improvements including new intermodal transfer areas, ferry facilities, bike/pedestrian improvements, passenger amenities
City and County of San Francisco	Port of San Francisco Fisherman's Wharf Ferry Terminal Improvements	Transit improvements including structural improvements, new intermodal transfer areas, ferry facilities, bike/pedestrian improvements
City and County of San Francisco	Mixed use and industrial development on Port of San Francisco property (various projects)	The Port has permitted numerous development projects including Mission Rock, Pier 70, the Warriors Arena, and plans for other commercial and industrial development in the waterfront area.
City of South San Francisco	Implement ferry service between South San Francisco and Alameda/Oakland	Transit improvement
City of Redwood City	Redwood City Ferry Terminal	Construct ferry terminal at Redwood City

**2.6.2 High-Speed Rail Alternatives for the San Francisco to San Jose Project Section**

This section presents detailed descriptions of the two end-to-end project alternatives identified as Alternative A and Alternative B. Because the two alternatives contain many common elements, these are described first, followed by a more detailed description of each alternative by subsection. Volume 3 of this Draft EIR/EIS contains the preliminary design drawings. Figure 2-1 illustrates the two project alternatives.

**2.6.2.1 Preferred Alternative**

On September 17, 2019, the Authority Board of Directors reviewed a staff recommendation on the Preferred Alternative and a summary of key identified outreach concerns. The Board confirmed that Alternative A is the Preferred Alternative for evaluation in this Draft EIR/EIS. The process for considering and the rationale for selecting the Preferred Alternative are presented in Chapter 8, Preferred Alternative, of this Draft EIR/EIS.

**2.6.2.2 Common Design Features**

The project would extend approximately 49 miles from the San Francisco 4th and King Street Station to West Alma Avenue in San Jose, sharing tracks with Caltrain using blended system infrastructure for its entirety under Alternative A, for 46 miles under Alternative B (Viaduct to I-880), or for 43 miles under Alternative B (Viaduct to Scott Boulevard). Stations providing HSR service would be located in San Francisco, Millbrae, and San Jose and an LMF would be built in the Brisbane Baylands area. The Project Section would follow the existing Caltrain right-of-way through urban cities and communities in San Francisco, San Mateo, and Santa Clara Counties, including San Francisco, Brisbane, South San Francisco, San Bruno, Millbrae, Burlingame, San Mateo, Belmont, San Carlos, Redwood City, North Fair Oaks, Atherton, Menlo Park, Palo Alto, Mountain View, and Sunnyvale. Alternative A would continue along the Caltrain right-of-way in Santa Clara and San Jose, while Alternative B would depart from the Caltrain right-of-way south of I-880 (Viaduct to I-880) or south of Scott Boulevard (Viaduct to Scott Boulevard). The Project Section would be comprised of the following five geographic subsections: San Francisco to South San Francisco, San Bruno to San Mateo, San Mateo to Palo Alto, Mountain View to Santa Clara, and San Jose Diridon Station Approach (Figure 2-1).

Operating on the two-track system primarily within the existing Caltrain right-of-way, the project would use existing and in-progress infrastructure improvements developed by Caltrain for its Caltrain Modernization Program, including electrification of the Caltrain corridor between San Francisco and San Jose as part of the PCEP and PTC. These improvements would provide consistent and predictable travel between San Francisco and San Jose. The blended system would accommodate operating speeds of up to 110 mph for up to four HSR trains and six Caltrain trains per hour per direction in the peak period.

Operation of the blended system would require additional infrastructure improvements and project elements beyond the Caltrain Modernization Program to accommodate HSR service. Design elements common to both alternatives include track modifications to support higher speeds while maintaining passenger comfort; station and platform modifications to accommodate HSR trains passing through or stopping at existing stations; and modifications to the OCS and TPFs installed by Caltrain as part of the PCEP. The project alternatives would implement safety improvements at existing at-grade roadway crossings and at Caltrain stations and platforms, as well as security modifications such as installing perimeter fencing along the right-of-way. The project would also include an LMF to accommodate planned operational needs for high-capacity rail movement and communication radio towers at approximately 2.5-mile intervals.

HSR and Caltrain are the only passenger rail services that would operate in the blended system. North of the Santa Clara Caltrain Station, freight would use the same tracks as HSR and Caltrain, but would operate at night with temporal separation to avoid conflicting with HSR and Caltrain operations. South of the Santa Clara Caltrain Station, freight and other passenger rail services (including ACE, Amtrak, and Capitol Corridor) operate presently and would continue to operate on separate UPRR-owned tracks.

### Track and Station Modifications

Depending on the alternative selected, between 9 and 12 of the existing 27 Caltrain stations between 4th and King Street in San Francisco and West Alma Avenue in San Jose would require varying degrees of modifications to accommodate HSR trains passing through or stopping at the stations. HSR trains would stop at the 4th and King Street, Millbrae, and San Jose Diridon Stations, requiring dedicated HSR platforms and associated passenger services to be provided at these stations. Other stations would also be modified to accommodate track adjustments, remove the hold-out rule, and build project features such as the Brisbane LMF and passing track.

The blended system would require curve straightening, track center modifications, and superelevation<sup>19</sup> of existing Caltrain tracks along approximately 36 to 44 percent of the project corridor (depending on the alternative) to support higher speeds of up to 110 mph. These track modifications are described under Section 2.6.2.4, Alternative A, and Section 2.6.2.5, Alternative B, and illustrated on Figures 2-28, 2-33, 2-37, 2-38, 2-39, 2-40, 2-42, and 2-44. Where horizontal track modifications would be greater than 1 foot, the OCS poles and wires would require relocation. Where track modifications would be made at existing Caltrain stations, adjustments to existing platforms would be required. Track modifications at San Bruno Station and Hayward Park Station under Alternatives A and B would require modifying or realigning the existing station platforms.

Three existing Caltrain stations—Broadway and Atherton Stations (both alternatives) and the College Park Station (Alternative A only)—would be modified as part of the blended system improvements to remove the existing hold-out rule. As illustrated on Figure 2-16, new outboard platforms would be built at these stations to eliminate the need for passengers to cross between the tracks. The Brisbane LMF would require relocation of a station platform and pedestrian overpass at the Bayshore Station in Brisbane.

---

<sup>19</sup> *Superelevation* is the vertical distance between the height of the inner and outer rails at a curve. Superelevation is used to partially or fully counteract the centrifugal force acting radially outward on a train when it is traveling along the curve.

### Safety and Security Modifications to the Right-of-Way

Consistent with FRA safety guidelines for HSR systems with operating speeds of up to 110 mph, the blended system would implement safety improvements at the at-grade crossings to create a “sealed corridor” that would reduce conflicts with automobiles and pedestrians. Depending on the configuration of the existing at-grade crossing, one of six different four-quadrant gate applications (illustrated on Figures 2-12, 2-13, and 2-14) would be installed at each of the 38 to 40 at-grade crossings (currently without four-quadrant gates) along the Project Section. Table 2-14 shows the number and locations of four-quadrant gate applications. These applications specify the improvements for each at-grade crossing, including the number of vehicle and pedestrian gates and the use of channelization or raised medians.

**Table 2-14 Number and Locations of Four-Quadrant Gate Applications within the Project Section**

Application	Number of At-Grade Crossings	Location of At-Grade Crossings
A	7 to 9	Mission Bay Drive and 16th Street (San Francisco); 4th Avenue, 5th Avenue, and 9th Avenue (San Mateo); Oak Grove Avenue and Ravenswood Avenue (Menlo Park); Mary Avenue (Sunnyvale); Auzerais Avenue and West Virginia Street (San Jose, Alternative A only)
B	11	Center Street (Millbrae); Oak Grove Avenue, North Lane, Howard Avenue, Bayswater Avenue, and Peninsula Avenue (Burlingame); Villa Terrace and Bellevue Avenue (San Mateo); Chestnut Street (Redwood City); Encinal Avenue (Menlo Park); Alma Street (Palo Alto)
B1	2	Scott Street (San Bruno); Watkins Avenue (Atherton)
C	4	Broadway (Burlingame); Whipple Avenue (Redwood City); Rengstorff and Castro Street (Mountain View)
D	7	Linden Avenue (South San Francisco); Brewster Avenue and Broadway (Redwood City); Churchill Avenue, Meadow Drive and Charleston Road (Palo Alto); Sunnyvale Avenue (Sunnyvale)
E	7	1st Avenue, 2nd Avenue, and 3rd Avenue (San Mateo); Maple Street, Main Street (Redwood City); and Glenwood Avenue (Menlo Park)
<b>Total</b>	<b>38 to 40</b>	Alternative A: 40 crossings; Alternative B: 38 crossings

Sources: Authority 2019a, 2019b

In addition to four-quadrant gates, the Authority would install fencing at the at-grade crossings and along the perimeter of the Caltrain corridor. Consistent with Caltrain’s design standards, existing fencing would be extended to adjacent structures to close any gaps. Figure 2-17 illustrates existing perimeter fencing of railroad rights-of-way.

### Train Control and Communication Facilities

HSR would require the installation of a radio-based communications network to maintain communications and share data between the trains and the operations control center. These facilities are described in Section 2.4.7, Signaling, Train-Control Elements, and Communication Facilities, and illustrated on Figure 2-18.

### Light Maintenance Facility

The Project Section would include an approximately 100- to 110-acre LMF in Brisbane. Designed to accommodate projected system growth to 2040, it would provide storage capacity for trains and accommodate light maintenance activities, including daily inspections, pre-departure cleaning, testing, and servicing between runs; monthly inspections; quarterly inspections; train

washing; and wheel truing. Two LMF site options for the Brisbane LMF, east and west of the mainline Caltrain tracks, are evaluated in this document as part of the two project alternatives and are described in more detail in Section 2.6.2.4 and Section 2.6.2.5.

### Roadway, Bridge, and Ramp Modifications

Roadway, bridge, and freeway ramp modifications would be necessary at certain locations along the Project Section. These modifications are described in more detail in Section 2.10.3.7, Roadway Modifications.

### Acquisition of New Right-of-Way

Both project alternatives would require permanent acquisition of new right-of-way outside of the existing Caltrain right-of-way. Table 2-15 provides an overview of the common project elements that would require new right-of-way acquisition by jurisdiction. Permanent right-of-way acquisition common to both project alternatives would be required for track modifications, installation of communication radio towers, roadway and station modifications, and construction of the Brisbane LMF. The major project elements common to both project alternatives that extend outside the Caltrain right-of-way include the 4th and King Street Station, Millbrae Station, San Jose Diridon Station, Brisbane LMF, Bayshore Station modifications, and Tunnel Avenue realignment and overpass. Refer to Volume 2, Appendix 3.1-A, Parcels within the HSR Project Footprint, for detailed mapping of the project footprint and parcels intersected by each project alternative. Section 3.12, Socioeconomics and Communities, provides a detailed discussion of displacements associated with new right-of-way acquisition, and Section 3.13, Station Planning, Land Use, and Development, discusses project impacts on existing and planned land uses consistent with the requirements of NEPA and CEQA.

**Table 2-15 New Right-of-Way Acquisitions Common to both Alternatives by City/Community and Project Element**

City/Community	Common Project Elements
<b>San Francisco to South San Francisco Subsection</b>	
San Francisco	4th and King Street Station; communication radio towers; Bayshore Station modifications
Brisbane	Bayshore Station modifications; track modifications; LMF; Tunnel Avenue realignment and overpass; communication radio towers
South San Francisco	N/A
<b>San Bruno to San Mateo Subsection</b>	
San Bruno	N/A
Unincorporated San Mateo County	Communication radio towers
Millbrae	Millbrae Station; track modifications; roadway relocation <sup>2</sup>
Burlingame	N/A
San Mateo (north of 9th Avenue)	Communication radio towers
<b>San Mateo to Palo Alto Subsection</b>	
San Mateo (south of 9th Avenue)	Communication radio towers
Belmont	Communication radio towers
San Carlos	Communication radio towers
Redwood City	N/A
North Fair Oaks	N/A

City/Community	Common Project Elements
Atherton	N/A
Menlo Park	Communication radio towers
Palo Alto	Communication radio towers
<b>Mountain View to Santa Clara Subsection</b>	
Mountain View	Communication radio towers
Sunnyvale	Communication radio towers
Santa Clara	N/A
<b>San Jose Diridon Station Approach Subsection</b>	
Santa Clara	N/A
San Jose	College Park Station modifications; roadway modifications; San Jose Diridon Station

Sources: Authority 2019a, 2019b  
 LMF = light maintenance facility  
 N/A = not applicable

**2.6.2.3 High-Speed Rail Project Impact Avoidance and Minimization Features**

The Authority has committed to implementing impact avoidance and minimization features (IAMF) consistent with the Statewide Final Program EIR/EIS (Authority and FRA 2005), the Bay Area to Central Valley Program EIR/EIS (Authority and FRA 2008), and the Bay Area to Central Valley Partially Revised Final Program EIR (Authority 2012c). The Authority would implement these features during project design and construction, as relevant to the HSR project section, to avoid or reduce impacts. These features are considered to be part of the project and are included as applicable in each of the alternatives for purposes of the environmental impact analysis. The full text of the IAMFs that are applicable to the project is provided in Volume 2, Appendix 2-E. Chapter 3 provides a brief description of each IAMF as well as its purpose in the context of each resource topic.

**To control emissions from construction and operations**

- AQ-IAMF#1: Fugitive Dust Emissions
- AQ-IAMF#2: Selection of Coatings
- AQ-IAMF#3: Renewable Diesel
- AQ-IAMF#4: Reduce Criteria Exhaust Emissions from Construction Equipment
- AQ-IAMF#5: Reduce Criteria Emissions from On-Road Construction Equipment

**To minimize visual incompatibility**

- AVQ-IAMF#1: Aesthetic Options
- AVQ-IAMF#2: Aesthetic Review Process

**To minimize impacts on biological resources**

- BIO-IAMF#1: Designate Project Biologist, Designated Biologists, Species-Specific Biological Monitors and General Biological Monitors
- BIO-IAMF#2: Facilitate Agency Access
- BIO-IAMF#3: Prepare WEAP Training Materials and Conduct Construction Period WEAP Training

- BIO-IAMF#4: Conduct Operations and Maintenance Period WEAP Training
- BIO-IAMF#5: Prepare and Implement a Biological Resources Management Plan
- BIO-IAMF#6: Establish Monofilament Restrictions
- BIO-IAMF#7: Prevent Entrapment in Construction Materials and Excavations
- BIO-IAMF#8: Delineate Equipment Staging Areas and Traffic Routes
- BIO-IAMF#9: Dispose of Construction Spoils and Waste
- BIO-IAMF#10: Clean Construction Equipment
- BIO-IAMF#11: Maintain Construction Sites
- BIO-IAMF#12: Design the Project to be Bird Safe

**To minimize impacts on cultural resources**

- CUL-IAMF#1: Geospatial Data Layer and Archaeological Sensitivity Map
- CUL-IAMF#2: WEAP Training Session
- CUL-IAMF#3: Pre-Construction Cultural Resource Surveys
- CUL-IAMF#4: Relocation of Project Features when Possible
- CUL-IAMF#5: Archaeological Monitoring Plan and Implementation
- CUL-IAMF#6: Pre-Construction Conditions Assessment, Plan for Protection of Historic Built Resources, and Repair of Inadvertent Damage
- CUL-IAMF#7: Built Environment Monitoring Plan
- CUL-IAMF#8: Implement Protection and/or Stabilization Measures

**To minimize electromagnetic issues**

- EMF/EMI-IAMF#1: Preventing Interference with Adjacent Railroads
- EMF/EMI-IAMF#2: Controlling Electromagnetic Fields/Electromagnetic Interference

**To minimize geologic issues and impacts on paleontological resources**

- GEO-IAMF#1: Geologic Hazards
- GEO-IAMF#2: Slope Monitoring
- GEO-IAMF#3: Gas Monitoring
- GEO-IAMF#5: Hazardous Minerals
- GEO-IAMF#6: Ground Rupture Early Warning Systems
- GEO-IAMF#7: Evaluate and Design for Large Seismic Ground Shaking
- GEO-IAMF#8: Suspension of Operations during an Earthquake
- GEO-IAMF#9: Subsidence Monitoring
- GEO-IAMF#10: Geology and Soils
- GEO-IAMF#11: Engage a Qualified Paleontological Resources Specialist
- GEO-IAMF#12: Perform Final Design Review and Triggers Evaluation
- GEO-IAMF#13: Prepare and Implement a Paleontological Resources Monitoring and Mitigation Plan
- GEO-IAMF#14: Provide WEAP Training for Paleontological Resources



- GEO-IAMF#15: Halt Construction, Evaluate, and Treat If Paleontological Resources Are Found

**To minimize impacts from hazardous materials and wastes**

- HMW-IAMF#1: Property Acquisition Phase I and Phase 2 Environmental Site Assessments
- HMW-IAMF#2: Landfill
- HMW-IAMF#3: Work Barriers
- HMW-IAMF#4: Undocumented Contamination
- HMW-IAMF#5: Demolition Plans
- HMW-IAMF#6: Spill Prevention
- HMW-IAMF#7: Transport of Materials
- HMW-IAMF#8: Permit Conditions
- HMW-IAMF#9: Environmental Management System
- HMW-IAMF#10: Hazardous Materials Plans

**To minimize impacts on water quality and supply**

- HYD-IAMF#1: Stormwater Management
- HYD-IAMF#2: Flood Protection
- HYD-IAMF#3: Prepare and Implement a Construction Stormwater Pollution Prevention Plan
- HYD-IAMF#4: Prepare and Implement an Industrial Stormwater Pollution Prevention Plan

**To minimize impacts from stations and changes in land use**

- LU-IAMF#1: HSR Station Area Development: General Principles and Guidelines
- LU-IAMF#2: Station Area Planning and Local Agency Coordination
- LU-IAMF#3: Restoration of Land Used Temporarily during Construction

**To minimize noise and vibration**

- NV-IAMF#1: Noise and Vibration

**To minimize impacts on parks, recreation, and open space**

- PK-IAMF#1: Parks, Recreation, and Open Space

**To minimize impacts on public utilities and energy**

- PUE-IAMF#1: Design Measures
- PUE-IAMF#3: Public Notifications
- PUE-IAMF#4: Utilities and Energy

**To maximize safety and security**

- SS-IAMF#1: Construction Safety Transportation Management Plan
- SS-IAMF#2: Safety and Security Management Plan
- SS-IAMF#3: Hazard Analyses

### To minimize socioeconomic impacts and impacts on communities

- SOCIO-IAMF#1: Construction Management Plan
- SOCIO-IAMF#2: Compliance with Uniform Relocation Assistance and Real Property Acquisition Policies Act
- SOCIO-IAMF#3: Relocation Mitigation Plan

### To minimize transportation and circulation impacts

- TR-IAMF#1: Protection of Public Roadways during Construction
- TR-IAMF#2: Construction Transportation Plan
- TR-IAMF#3: Off-Street Parking for Construction-Related Vehicles
- TR-IAMF#4: Maintenance of Pedestrian Access
- TR-IAMF#5: Maintenance of Bicycle Access
- TR-IAMF#6: Restriction on Construction Hours
- TR-IAMF#7: Construction Truck Routes
- TR-IAMF#8: Construction during Special Events
- TR-IAMF#9: Protection of Freight and Passenger Rail during Construction
- TR-IAMF#11: Maintenance of Transit Access
- TR-IAMF#12: Pedestrian and Bicycle Safety

#### 2.6.2.4 Alternative A

Alternative A would modify approximately 17.4 miles of existing Caltrain track, predominantly within the existing Caltrain right-of-way, build the East Brisbane LMF, modify nine existing stations or platforms to accommodate HSR, and install safety improvements and communication radio towers. Caltrain has several locations of four-track segments where trains can pass; no additional passing tracks would be built under Alternative A. Table 2-16 presents a summary of the alternative's design features, followed by a more detailed description by subsection.

**Table 2-16 Summary of Design Features for Alternative A**

Feature	Alternative A
Length of existing Caltrain track (miles) <sup>1</sup>	48.9
Length of modified track (miles) <sup>1</sup>	17.4
Length of track modification <1 foot (miles) <sup>1</sup>	5.7
Length of track modification >1 foot and <3 feet (miles) <sup>1</sup>	2.2
Length of track modification > 3 feet (miles) <sup>1</sup>	9.5
Length of OCS pole relocation (miles) <sup>1,2</sup>	11.7
Includes additional passing tracks	No
LMF	East Brisbane
Modified stations	
Modifications to HSR stations	4th and King Street, Millbrae, San Jose Diridon
Modifications to Caltrain stations due to the LMF	Bayshore (relocated)
Modifications to Caltrain stations due to track shifts	San Bruno, Hayward Park
Modifications to Caltrain stations to remove hold-out rule	Broadway, Atherton, College Park

Feature	Alternative A
Number of modified or new structures <sup>3</sup>	21
New structures	2
Modified structures	7
Replaced structures	9
Affected retaining walls	3
Number of at-grade crossings with safety modifications (e.g., four-quadrant gates, median barriers)	40
Length of new perimeter fencing (miles) <sup>1</sup>	8.8
Communication radio towers	21

Sources: Authority 2019a, 2019b

LMF = light maintenance facility

OCS = overhead contact system

<sup>1</sup> Lengths shown are guideway mileages, rather than the length of the northbound and southbound track.

<sup>2</sup> OCS pole relocations are assumed for areas with track shifts greater than 1 foot.

<sup>3</sup> Structures include bridges, grade separations such as pedestrian underpasses and overpasses, tunnels, retaining walls, and culverts.

### San Francisco to South San Francisco Subsection

The San Francisco to South San Francisco Subsection would extend approximately 10 miles from the 4th and King Street Station in downtown San Francisco to Linden Avenue in South San Francisco, through the cities of San Francisco, Brisbane, and South San Francisco. The existing Caltrain track in this subsection is predominantly two-track at grade, with four two-track tunnel segments in San Francisco and a four-track at-grade section through Brisbane. As illustrated on Figure 2-28, this alternative would modify the existing 4th and King Street and Bayshore Stations, build the East Brisbane LMF and associated track modifications, reconfigure Tunnel Avenue, install four-quadrant gates at three existing at-grade crossings, and install six communication radio towers. Additional right-of-way would be required in San Francisco and Brisbane to accommodate track modification, the East Brisbane LMF, Tunnel Avenue reconfiguration, four-quadrant gates, and communication radio towers.



Source: Authority 2019a

MAY 2019

**Figure 2-28 San Francisco to South San Francisco Subsection—Alternative A**

### **4th and King Street Station**

The existing 4th and King Street Station would serve as the interim terminal station for the project until the DTX provides HSR access to the SFTC. Figure 2-29 illustrates the site plan for the interim station. Station improvements would include installing a booth for HSR ticketing and support services, adding HSR fare gates, and modifying existing tracks and platforms. Until the DTX can provide service to the SFTC, passengers would be required to use alternate methods of transportation to get there (e.g., MUNI, ride-share program, walking). Figure 2-30 and Figure 2-31 present a cross-section view of the HSR tracks and platforms at 4th and King Street Station looking northeast.

To support HSR operations, two existing Caltrain platforms in the center of the station yard would be raised and lengthened to serve four northbound and southbound HSR tracks. The HSR platforms would be approximately 4.25 feet high, with lengths of 1,000 feet for the platform on the east and 1,400 feet for the platform on the west. Ramps would be installed to provide pedestrian access from the station building to the raised platforms. Four existing Caltrain platforms, 600 feet long, would remain on either side of the HSR platforms to serve eight Caltrain tracks.

### **East Brisbane Light Maintenance Facility**

The East Brisbane LMF would be built south of the San Francisco tunnels on approximately 100 acres east of the Caltrain corridor. Direct HSR mainline track access would be provided along double-ended yard leads that would cross over the mainline track on an aerial flyover at the north end, with an at-grade track entering the LMF from the south. Transition tracks (approximately 1,400 feet long) would allow trains to reduce or increase speed when entering or exiting the East Brisbane LMF.

The East Brisbane LMF (Figure 2-32) would include a maintenance yard with 17 yard tracks adjacent and parallel to a maintenance building containing eight shop tracks with interior access and inspection pits for underside and truck inspections. The maintenance building would provide storage areas for reserve equipment, workshops, and office space. A power generator, sewage system, cistern, collection point, and electrical substation would be north of the maintenance building with a 400-space surface parking lot for automobiles and trucks east of the maintenance building. An access road would connect the facility to the realigned Tunnel Avenue.

The track modifications associated with the East Brisbane LMF would require relocating the Bayshore Caltrain Station, relocating the Tunnel Avenue overpass, widening the bridge crossing of Guadalupe Valley Creek in Brisbane, and relocating control point (CP) Geneva. The reconstructed Tunnel Avenue overpass would connect to Bayshore Boulevard at its intersection with Valley Drive (north of its existing connection) and would provide a roadway extension connecting Valley Drive to Old Country Road. The widened Guadalupe Valley Creek Bridge would support the East Brisbane LMF lead tracks where they cross the creek. Track modification near CP Geneva could require relocating the overhead signal pole.

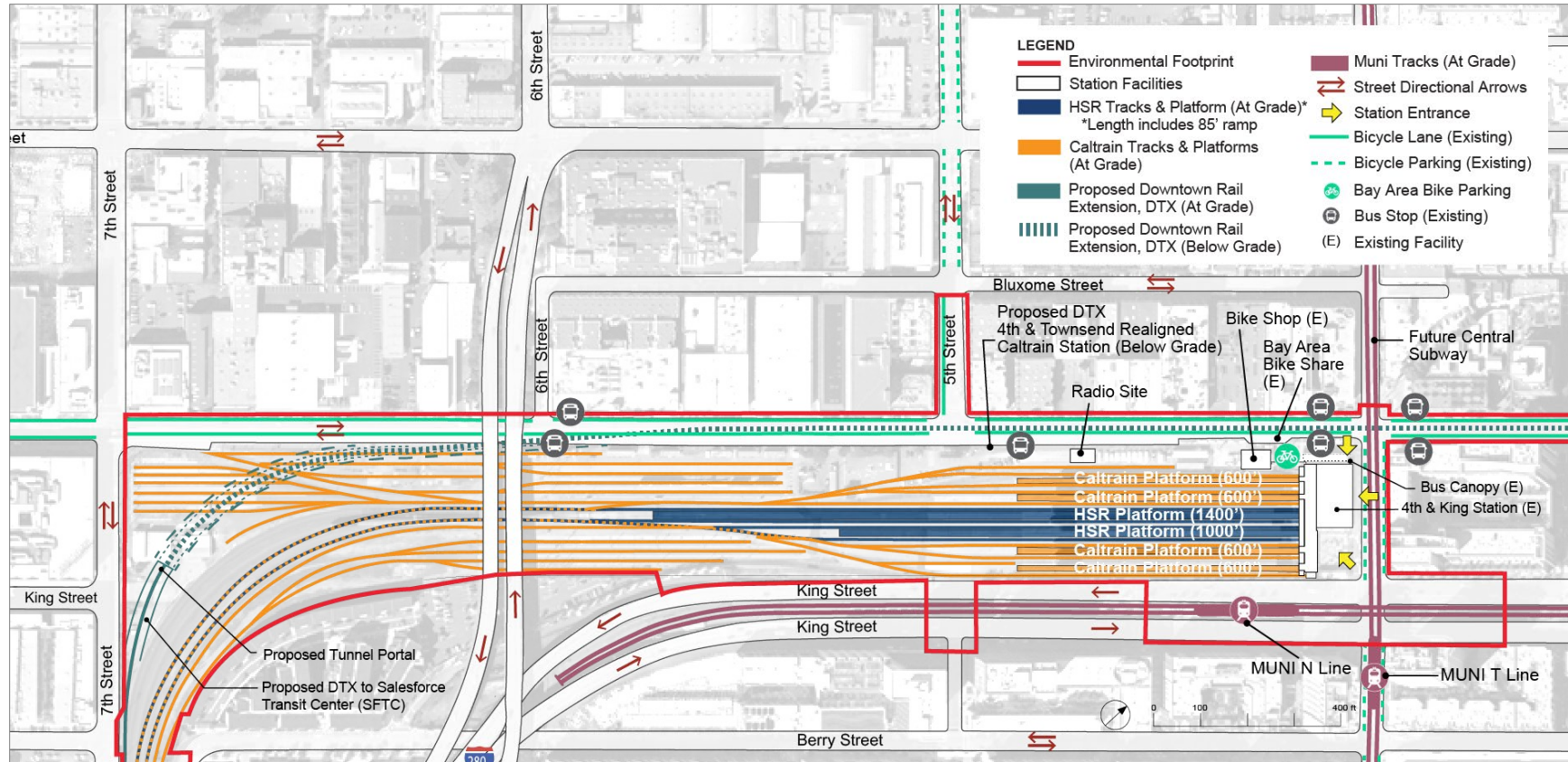

Source: Authority 2019a

MAY 2019

Figure 2-29 4th and King Street Station Site Plan—Alternatives A and B

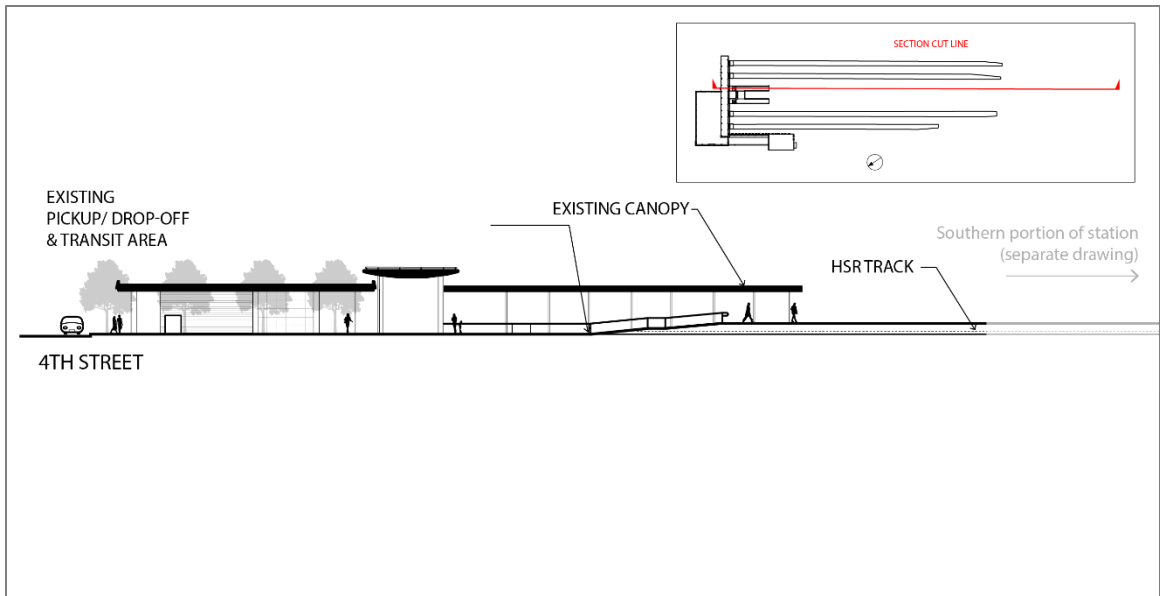

Source: Authority 2019a

MAY 2019

**Figure 2-30 4th and King Street Station Cross Section (Northern Portion)— Alternatives A and B**

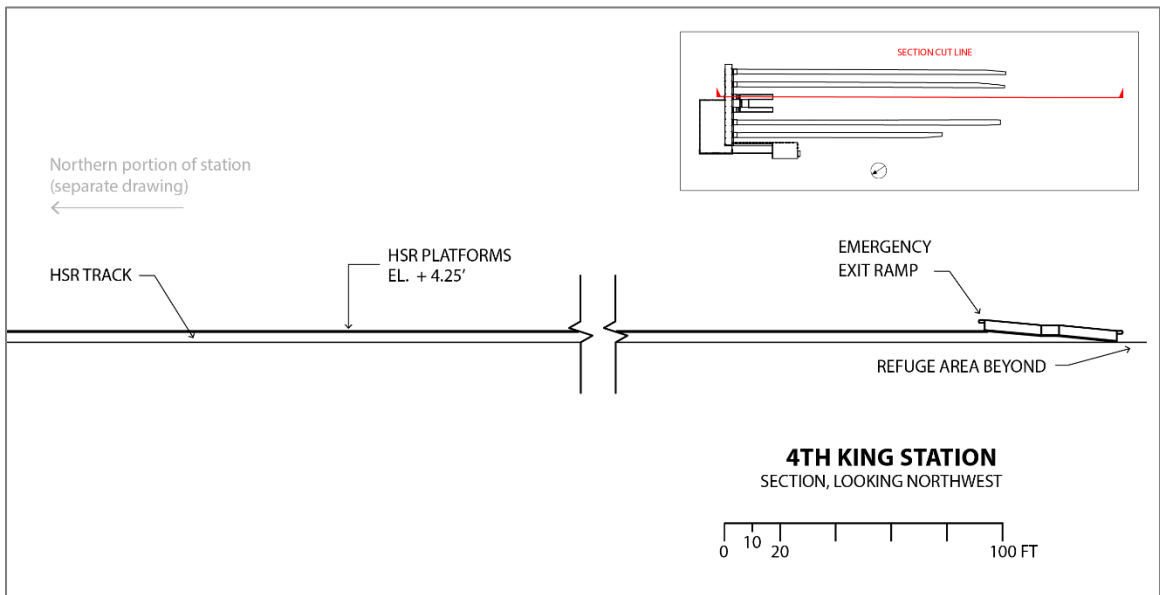

Source: Authority 2019a

MAY 2019

**Figure 2-31 4th and King Street Station Cross Section (Southern Portion)— Alternatives A and B**

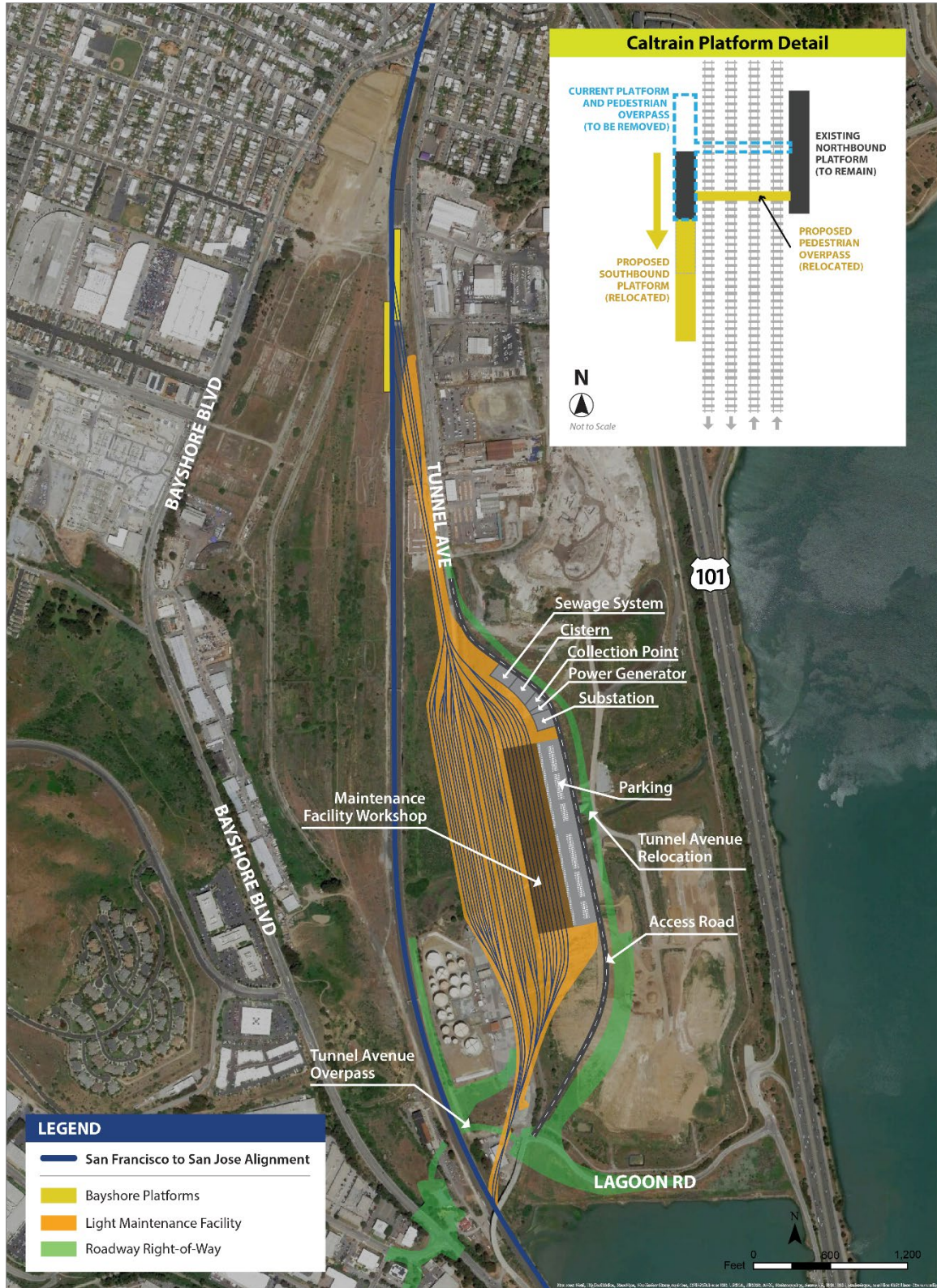

Source: Authority 2019a

SEPTEMBER 2018

Figure 2-32 East Brisbane Light Maintenance Facility Layout—Alternative A



### **Track and Station Modifications**

Track and station modifications in the San Francisco to South San Francisco Subsection (Figure 2-28) are predominantly associated with the 4th and King Street Station modifications and the East Brisbane LMF. To accommodate the realignment of the mainline tracks for the East Brisbane LMF, the Bayshore Caltrain Station and associated surface parking lot, southbound platform, and a new pedestrian overpass would be reconstructed approximately 0.2 mile south of the existing station (illustrated in the inset of Figure 2-32). A new pedestrian overpass would access the reconstructed station by connecting to Tunnel Avenue on the east and the planned local roadway network envisioned in the *Draft Brisbane Baylands Specific Plan* on the west (City of Brisbane 2011). The relocated Bayshore Caltrain Station would be closer to the planned Geneva Avenue extension, which would extend from Bayshore Boulevard to US 101.

Track modifications not associated with the 4th and King Street Station, the approach to the 4th and King Street Station, and East Brisbane LMF would be limited to minor track shifts of less than 1 foot within the existing right-of-way in San Francisco and South San Francisco, and track modifications in South San Francisco to accommodate the planned South San Francisco Caltrain Station Improvement Project being implemented by Caltrain in coordination with the City of South San Francisco. Expected to be built by 2019, the improvement project would replace the existing South San Francisco Station platforms (which are subject to the hold-out rule) with a standard center boarding platform connected to a pedestrian underpass, to improve safety and eliminate the hold-out rule. The project would shift tracks up to 27 feet, install crash barriers at the Grand Avenue overpass, and replace columns that support the US 101 overpass with a pair of solid pier walls.

### **Safety and Security Modifications to the Right-of-Way**

To improve safety, four-quadrant gates would be installed at three at-grade crossings in the subsection—Mission Bay Drive, 16th Street, and Linden Avenue (Figure 2-28). Table 2-14 specifies the four-quadrant gate application for each at-grade crossing, and Figures 2-12, 2-13, and 2-14 illustrate the configurations of these applications. Perimeter fencing (Figure 2-17) would be installed along the right-of-way where it does not already exist.

### **Train Control and Communication Facilities**

There would be six communication radio towers in this subsection (Figure 2-28). Two site options are evaluated for each standalone communications radio tower, with the exception of a single site option at 4th and King Street Station and at Blanken Avenue; however, only one site would be selected for construction at each of the six locations:

- Standalone radio tower at 4th and King Street Station in San Francisco (one site option)
- Co-located radio tower at Caltrain's Paralleling Station 1 in the Potrero Hill neighborhood of San Francisco
- Standalone radio tower in the Bayview neighborhood of San Francisco (either at Jerrold Avenue or Newcomb Avenue)
- Standalone radio tower at Blanken Avenue in Brisbane (one site option)
- Standalone radio tower in Brisbane adjacent to Bayshore Boulevard (two site options)
- Co-located radio tower at Caltrain's TPS 1 in South San Francisco

### **San Bruno to San Mateo Subsection**

The San Bruno to San Mateo Subsection would extend approximately 8 miles from Linden Avenue in South San Francisco to Ninth Avenue in San Mateo through South San Francisco, San Bruno, Millbrae, Burlingame, and San Mateo. The existing Caltrain track in this subsection is predominantly two-track at grade on retained fill with a three-track at-grade section south of the Millbrae Station. As illustrated on Figure 2-33, this subsection would modify the existing San Bruno, Millbrae, and Broadway Caltrain Stations; modify track; install four-quadrant gates at 16

existing at-grade crossings; and install three communication radio towers. Additional right-of-way would be required in Millbrae, Burlingame, and San Mateo associated with communication radio towers, the Millbrae Station modifications to accommodate HSR service, track modifications, roadway relocations, and four-quadrant gates.

### **Millbrae Station**

New HSR infrastructure would be built at the existing Millbrae BART/Caltrain Intermodal Station. As illustrated on Figure 2-34, new HSR station facilities on the west side of the existing Caltrain corridor would include a new station entrance hall with ticketing and support services along El Camino Real. The station area design provides intermodal connectivity with Caltrain and BART via an overhead pedestrian crossing that would extend from the new station entrance over the extension of California Drive, connecting to the existing station concourse with vertical circulation elements (stairs, escalators, and elevators) providing access to HSR, Caltrain, and BART platforms.

The primary access to the Millbrae HSR Station is intended to be by transit (Caltrain, BART, SamTrans); bicycles; walking; and vehicle pick-up and drop-off. Pick-up and drop-off facilities for vehicles would accommodate shuttles, taxis, car sharing, network transportation services, and private vehicles.

Enhanced automobile access would be provided on the west side of the station through the extension of California Drive to Victoria Avenue. Curbside passenger pick-up and drop-off facilities west of the station would be located along the new extension of California Drive and El Camino Real; facilities east of the station would be on the first level of the BART parking structure. Replacement parking for displaced Caltrain and BART parking would be provided at four surface parking lots on the west side of the alignment, with a fifth parking area at Murchison Drive with 34 parking spots for HSR passengers. HSR passengers desiring to drive and park would be able to use available long-term commercial parking off-site or at SFO and reach the station by shuttle.

The SamTrans bus stops would be along El Camino Real at the new signalized intersection and pedestrian crossings at Chadbourne Avenue, with direct access to the station. A new dedicated bicycle path would provide west side bicycle access to the station. Figure 2-35 and Figure 2-36 illustrate cross-section views of the Millbrae Station looking south.

Track modifications extending approximately 1 mile north and south of the station would require additional right-of-way along the west side of the Caltrain corridor and modification of existing Caltrain tracks, station platforms, and structures. Constructing two new tracks would require widening the Hillcrest Boulevard underpass north of the Millbrae Station. At the station, the existing BART tracks and platforms and the easternmost Caltrain track (mainline track [MT]1) and platform would remain unchanged. The westernmost Caltrain track (MT2) would be shifted west by up to 40 feet for construction of two new tracks serving an 800-foot-long center HSR platform and a new Caltrain MT2 outboard platform. The historic Southern Pacific Depot/Millbrae Station (previously relocated to accommodate station improvements) and associated surface parking along California Drive would be relocated to accommodate these track modifications.



Source: Authority 2019a

SEPTEMBER 2018

**Figure 2-33 San Bruno to San Mateo Subsection—Alternatives A and B**

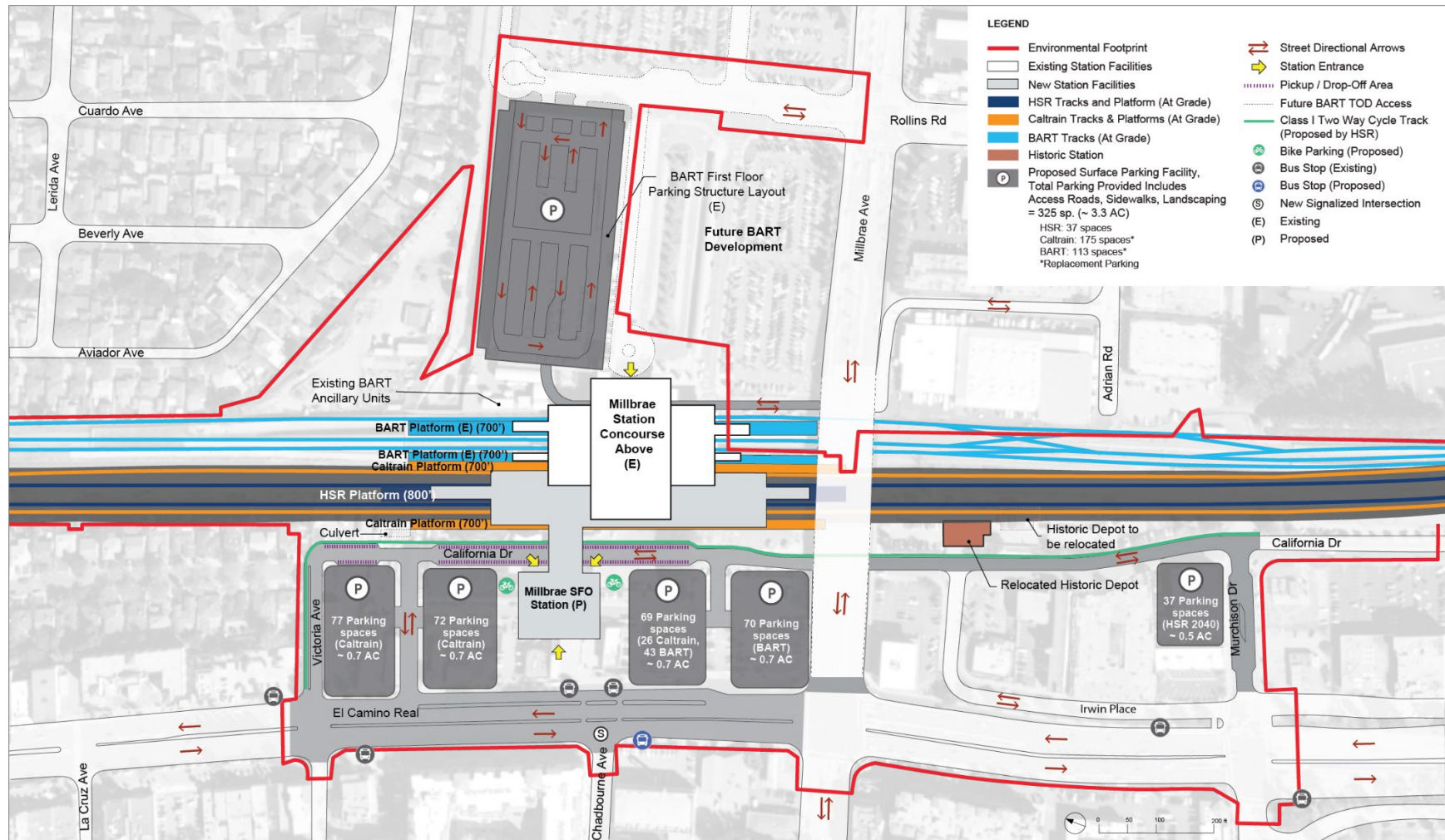

Source: Authority 2019a

MAY 2019

Figure 2-34 Millbrae Station Site Plan—Alternatives A and B

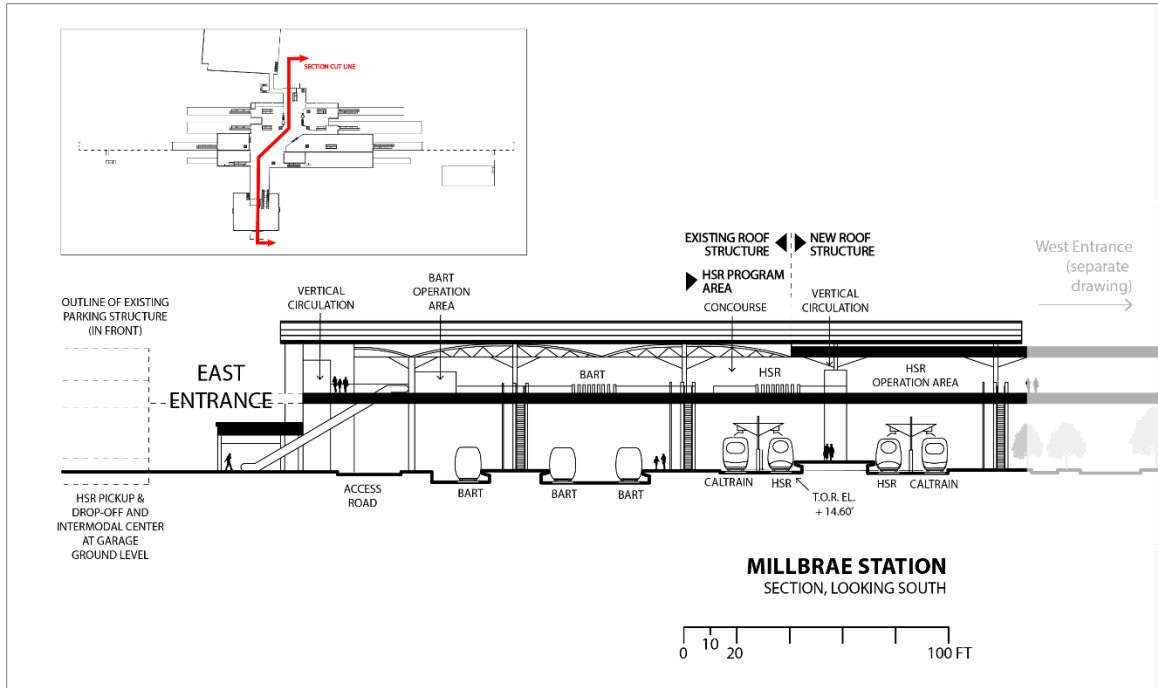

Source: Authority 2019a

MAY 2019

Figure 2-35 Millbrae Station Cross Section (East Entrance)—Alternatives A and B

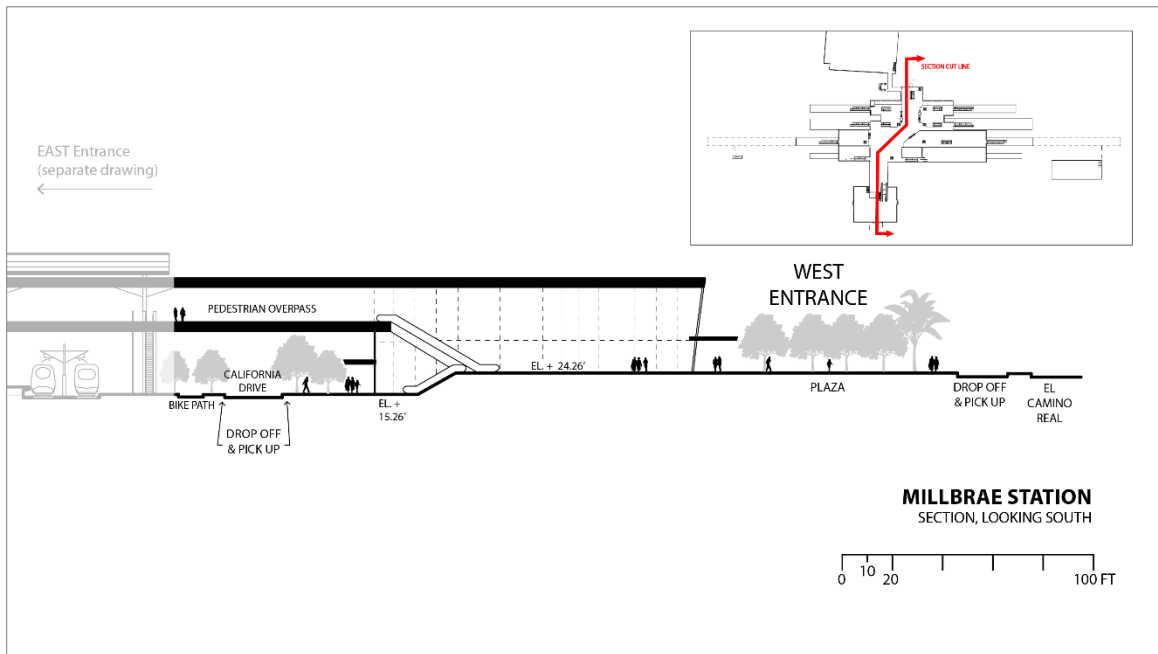

Source: Authority 2019a

MAY 2019

Figure 2-36 Millbrae Station Cross Section (West Entrance)—Alternatives A and B

### ***Track and Station Modifications***

Track and station modifications in this subsection include curve straightening near the San Bruno Station, platform modifications at the Broadway Station to eliminate the hold-out rule, and several minor track shifts in San Bruno and San Mateo. The curve straightening at the San Bruno Station would require an extension of the existing platforms approximately 145 feet south and relocation of the existing stairs/ramps from the northern to southern side of the northbound platform. The Euclid Avenue pedestrian underpass, just north of the San Bruno Station, would be widened to support the realigned tracks, and the concrete retaining wall along the east side would be modified to accommodate the realigned tracks.

Safety-related modifications would be made to the Broadway Station, including platform upgrades that would eliminate the hold-out rule by adding a second outboard platform to serve the northbound track and extending the southbound platform (Figure 2-16). The southbound platform extension would affect the station's surface parking along California Drive, and minor track shifts south of the Broadway Station would require widening of the Sanchez Creek and Mills Creek Culverts.

### ***Safety and Security Modifications to the Right-of-Way***

To improve safety, four-quadrant gates and channelizers would be installed at 16 at-grade crossings: Scott Street, Center Street, Broadway, Oak Grove Avenue, North Lane, Howard Avenue, Bayswater Avenue, Peninsula Avenue, Villa Terrace, Bellevue Avenue, First Avenue, Second Avenue, Third Avenue, Fourth Avenue, Fifth Avenue, and Ninth Avenue. As illustrated on Figure 2-33, most of these crossings are in Burlingame and San Mateo. Table 2-14 specifies the four-quadrant gate application for each at-grade crossing, and Figures 2-12, 2-13, and 2-14 illustrate the configurations of these applications. Perimeter fencing (Figure 2-17) would be installed along the right-of-way where it does not already exist.

### ***Train Control and Communication Facilities***

Three communication radio towers would be built in the subsection. Locations of these facilities—a new standalone radio tower near SFO (either at San Marco Avenue or Santa Lucia Avenue), a co-located radio tower at Paralleling Station 3 in Burlingame, and a new standalone radio tower in San Mateo near Cypress or Second Avenue—are illustrated on Figure 2-33. Two site options are evaluated for each standalone communications radio tower; however, only one site would be selected for construction.

### ***San Mateo to Palo Alto Subsection***

The San Mateo to Palo Alto Subsection would extend approximately 16 miles from Ninth Avenue in San Mateo to San Antonio Road in Palo Alto through San Mateo, Belmont, San Carlos, Redwood City, Atherton, Menlo Park, and the northern portion of Palo Alto (Figure 2-37 and Figure 2-38). The existing Caltrain track in this subsection is predominantly two-track at grade on retained fill. This alternative would modify platforms at the existing Hayward Park and Atherton Stations, modify tracks, install four-quadrant gates at 15 existing at-grade crossings, and install seven communication radio towers. Minor amounts of additional right-of-way would be required in San Mateo, Belmont, San Carlos, Redwood City, Menlo Park, and Palo Alto for the siting of four-quadrant gates and communication radio towers.

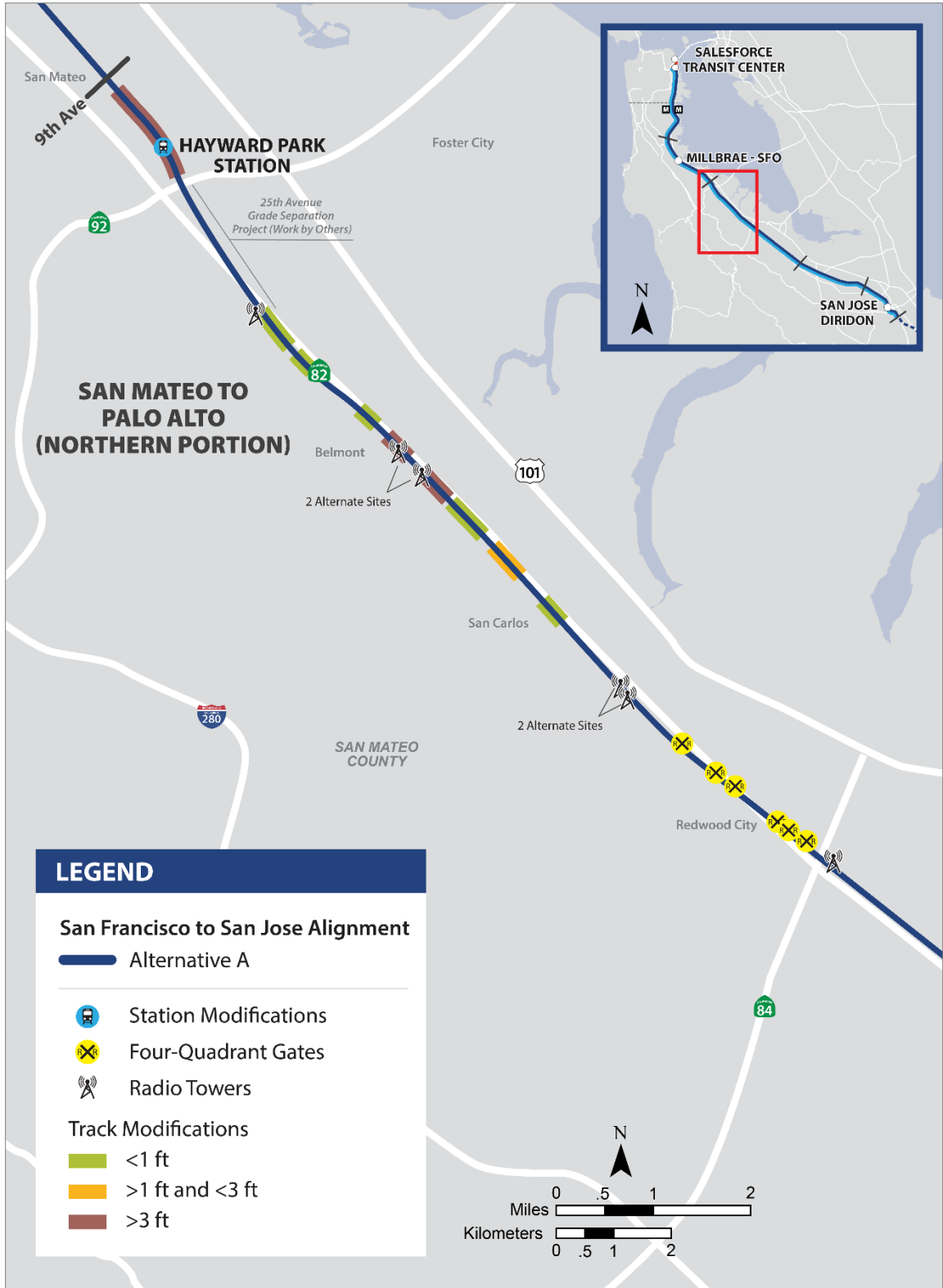

Source: Authority 2019a

MAY 2019

**Figure 2-37 San Mateo to Palo Alto Subsection (Northern Portion)—Alternative A**



Source: Authority 2019a

MAY 2019

**Figure 2-38 San Mateo to Palo Alto Subsection (Southern Portion)—Alternatives A and B**



### **Track and Station Modifications**

Track and station modifications in this subsection (Figures 2-37 and 2-38) consist of curve straightening predominantly in San Mateo, Belmont, San Carlos, and Palo Alto, platform modifications at the Hayward Park Station to accommodate curve straightening and platform modifications at the Atherton Station to remove the hold-out rule by extending the southbound platform and adding a second outboard platform to serve the northbound track. In several locations, these track modifications would result in modifications to existing Caltrain structures: track shifts south of Ralston Street in Belmont and north of Holly Street in San Carlos would require the modifying the existing retaining walls along the west side of the Caltrain corridor to accommodate the shifted track. The HSR project would be compatible with Caltrain and the City of San Mateo's planned 25th Avenue Grade-Separation Project. This grade-separation project, expected to be built by 2020, would elevate the existing at-grade track between SR 92 and Hillsdale Boulevard to provide a grade-separated undercrossing of 25th Avenue, build new east-west crossings under the track corridor at 28th and 31st Avenues, and relocate Hillsdale Station. No design changes to the 25th Avenue Grade-Separation Project are expected to result from the blended system.

### **Safety and Security Modifications to the Right-of-Way**

To improve safety, four-quadrant gates and median barriers would be installed at 15 at-grade crossings: Whipple Avenue, Brewster Avenue, Broadway, Maple Street, Main Street, Chestnut Street, Watkins Avenue, Encinal Avenue, Glenwood Avenue, Oak Grove Avenue, Ravenswood Avenue, Alma Street, Churchill Avenue, Meadow Drive, and West Charleston Road. As illustrated on Figures 2-37 and 2-38, most of these crossings are in Redwood City, Menlo Park, and Palo Alto. Table 2-14 specifies the four-quadrant gate application for each at-grade crossing, and Figures 2-12, 2-13, and 2-14 illustrate the configurations of these applications. Perimeter fencing would be installed along the right-of-way where it does not already exist (Figure 2-17).

### **Train Control and Communication Facilities**

Seven communication radio towers would be built (Figures 2-37 and 2-38). Two site options are evaluated for each standalone communications radio tower; however, only one site would be selected for construction at each location:

- Co-located radio tower at Caltrain's Paralleling Station 4 south in San Mateo
- Standalone radio tower near the Belmont Station (either Middle Road or Ralston Avenue)
- Standalone radio tower in San Carlos (either near El Camino Real/Central Avenue or Center Street)
- Co-located radio tower at Caltrain's Switching Station 1, Option 2 in Redwood City
- Standalone radio tower in Menlo Park (either at Derby Lane or Ravenswood Avenue)
- Standalone radio tower in Palo Alto north of Embarcadero Road
- Standalone radio tower in Palo Alto north of West Charleston Road

### **Mountain View to Santa Clara Subsection**

The Mountain View to Santa Clara Subsection would extend approximately 9 miles from San Antonio Road in Palo Alto to Scott Boulevard in Santa Clara through Palo Alto (southern portion), Mountain View, Sunnyvale, and Santa Clara. The existing Caltrain track in this subsection is predominantly two-track at grade (except for the four-track section from North Fair Oaks to north of Bowers Avenue) and there are no major project features in this subsection. As illustrated on Figure 2-39, this alternative would make minor track modifications, install four-quadrant gates at four at-grade crossings, and install four communication radio towers. Minor amounts of additional right-of-way would be required in Palo Alto, Mountain View, Sunnyvale, and Santa Clara for communication radio towers.



Source: Authority 2019a

MAY 2019

**Figure 2-39 Mountain View to Santa Clara Subsection—Alternative A and B**

### **Track and Station Modifications**

Minor track shifts of less than 1 foot would be required in several locations in Mountain View, Sunnyvale, and Santa Clara. The largest track shift in this subsection would be a shift of 2.5 feet near Bowers Avenue in Santa Clara. None of these shifts would require modifying existing Caltrain structures or stations.

### **Safety and Security Modifications to the Right-of-Way**

To improve safety, four-quadrant gates and median barriers would be installed at four at-grade crossings in Mountain View and Sunnyvale: Rengstorff Avenue, Castro Street, Mary Avenue, and Sunnyvale Avenue (Figure 2-39). Table 2-14 specifies the four-quadrant gate application for each at-grade crossing, and Figures 2-12, 2-13, and 2-14 illustrate the configurations of these applications. Perimeter fencing would be installed along the right-of-way where it does not already exist (Figure 2-17).

### **Train Control and Communication Facilities**

Four communication radio towers would be installed. Two site options are evaluated for each standalone communications radio tower; however, only one site would be selected for construction at each location:

- Standalone radio tower in Mountain View (near North Shoreline Boulevard)
- Standalone radio tower in Sunnyvale east of SR 237 (near East Bernardo Avenue)
- Co-located radio tower at Caltrain's Paralleling Station 6 near the Sunnyvale Station
- Standalone radio tower in Sunnyvale east of County Road G2 (near Lawrence Expressway)

### **San Jose Diridon Station Approach Subsection**

Under Alternative A, the San Jose Diridon Station Approach Subsection extends 6 miles from Scott Boulevard in blended service with Caltrain on an at-grade profile following Caltrain MT2 and MT3 south along the east side of the existing Caltrain corridor (Figure 2-40). The existing Caltrain track in this subsection consists of predominantly two-track and three-track at-grade alignment. South of De La Cruz Boulevard, UPRR tracks of the Coast Line from the northeast converge with the Caltrain corridor and continue south adjacent to the east side of the railroad corridor to the Santa Clara Caltrain Station. Between the College Park Caltrain Station and San Jose Diridon Station, Caltrain's CEMOF comprises three mainline tracks, a maintenance building, and nine yard tracks. San Jose Diridon Station includes five passenger platforms served by nine yard tracks along the west side of the station house.

### **Station Modifications**

The existing Santa Clara Station would remain. The existing College Park Caltrain Station would be reconstructed just north of Emory Street on the west side of the Caltrain corridor on the existing siding track to eliminate the existing hold-out rule at the station.

The San Jose Diridon Station would entail a four-track at-grade alignment through the center of the existing Diridon Station, with 1,385- and 1,465-foot platforms centered between Santa Clara Street and Park Avenue (Figure 2-41). The existing historic train station would remain in place. A pedestrian concourse would be built above the yard to provide access to the platforms below. The concourse would consist of a pedestrian walkway above the existing Caltrain tracks and below the HSR platforms, with two entrances on the east side and one on the west.

Construction of San Jose Diridon Station would require displacement of 226 parking spaces. These spaces would be replaced 1:1 in a parking structure at Cahill/Crandall Streets and a second site at Stockton/Alameda Streets. HSR parking demand of 1,050 spaces in 2040 would be met by commercially available parking downtown as well as at SJC (approximately 3 miles from the station). The Authority has provided a Station Area Planning grant to the City of San Jose to advance the implementation of the Diridon Station Area Plan adopted by the San Jose City Council. Through this effort, the City would address short-term parking needs during HSR and BART Phase II construction and would also address plans for transitioning the parking

needed during construction to the highest and best use after construction. Another Station Area Planning grant to the VTA would fund a San Jose Diridon Station Facilities Master Plan. This grant would develop a parking program to manage parking demand and supply over time to reflect changes in ridership and park-and-ride mode share. These two studies would provide input into a multimodal access plan for the station that would be developed prior to final station design and construction. Existing underutilized parking capacity at and around the San Jose Diridon Station would be used to meet the estimated HSR parking demand until a station area parking policy and program are implemented. The Authority would rely on commercially available parking to meet HSR parking demand, provided and priced in accordance with local conditions. HSR riders would be able to walk or take a shuttle, such as the City of San Jose's DASH, from parking downtown or adjacent to the station.

The existing on-site/off-street bus transit center would be relocated to an off-street facility between Cahill, Crandall, South Montgomery, and West San Fernando Streets. Street improvements would include reconfiguring and extending Cahill Street from Santa Clara Street to Otterson Street and extending Stover and Crandall Streets to South Montgomery Street. New bike lanes would be installed on the east side of Cahill Street. New signals and pedestrian crossings would be developed at Cahill and Stover Streets and Cahill and Crandall Streets.



Note: Although not depicted in the figure, within this subsection both project alternatives would involve track modifications; station modifications at Santa Clara Station under Alternative B (Viaduct to Scott Boulevard), College Park Station under Alternative A and Alternative B (Viaduct to I-880), and San Jose Diridon Station under both project alternatives; installation of two four-quadrant gates under Alternative A; installation of one radio tower under both project alternatives; and installation of a new traction power substation under Alternative B (both viaduct options).

Source: Authority 2019b

JUNE 2019

**Figure 2-40 San Jose Diridon Station Approach Subsection—Alternatives A and B**

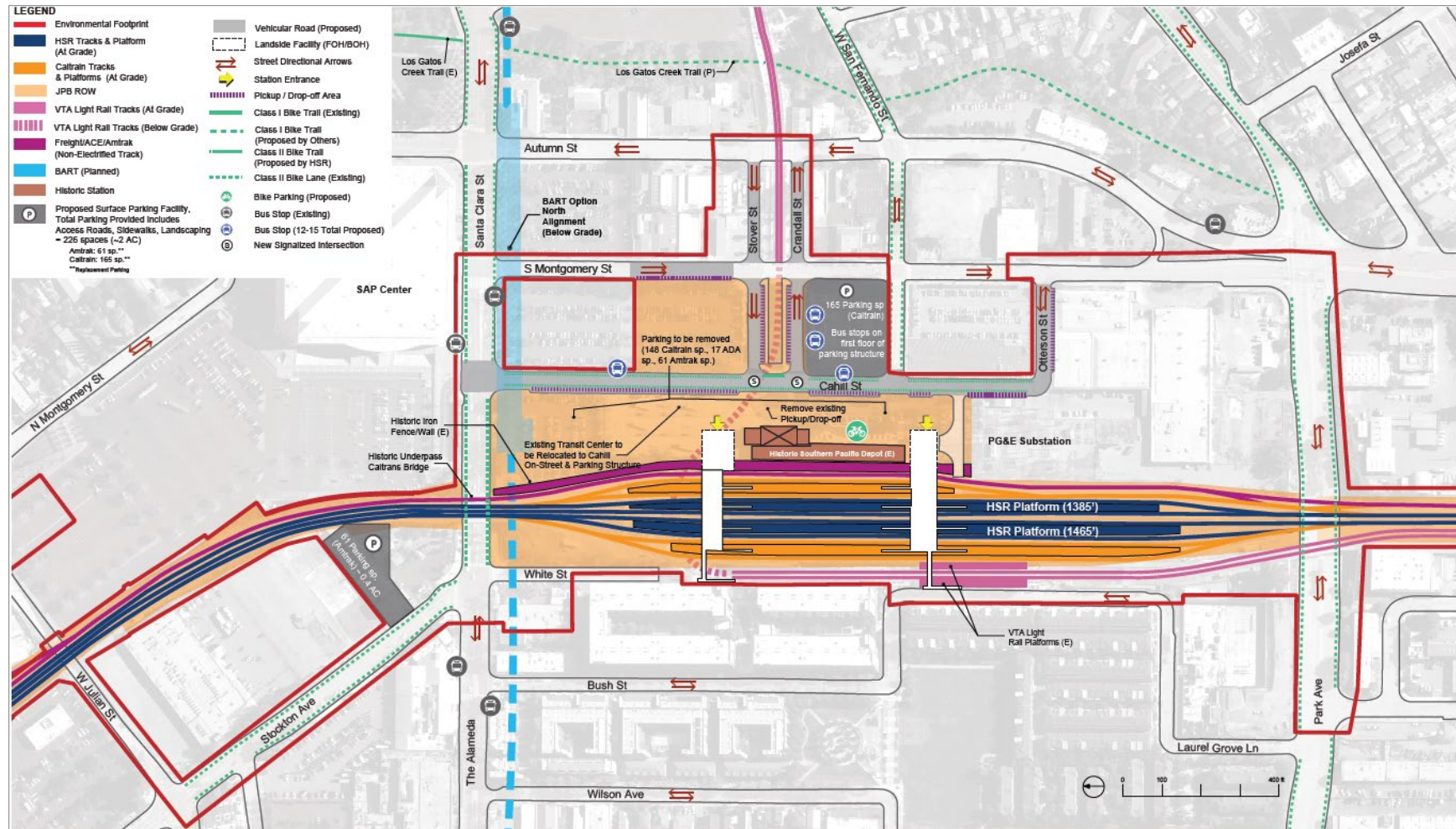

Source: Authority 2019b

JANUARY 2019

Figure 2-41 Conceptual San Jose Diridon At-Grade Station Plan

Initial operations include a pedestrian overhead crossing (PED OC) south of the existing historic station and would provide circulation access from the PED OC only to HSR platforms. Caltrain would continue to use the existing tunnel for access. Phasing for Valley-to-Valley service (2029) includes access to and from all Caltrain and HSR platforms. At this stage, the existing tunnel would be used only for exiting purposes on HSR platforms. At buildout, there would be an additional PED OC north of the historic station with access to all Caltrain and HSR platforms. From the HSR platforms, the existing tunnel would continue to be used only for exiting.

### **Track Modifications**

The existing Lafayette Street pedestrian overpass would remain in place, as would the De La Cruz Boulevard and West Hedding Street roadway overpasses. New UPRR track would start just south of Emory Street to maintain freight movement capacity north of San Jose Diridon Station. The new UPRR track would be east of Caltrain MT1. A portion of both legs of the UPRR Warm Springs Subdivision Lenzen Wye would undergo minor track adjustments, and a new bridge would be built over Taylor Street for UPRR to tie into the Lenzen Wye.

The blended at-grade alignment would continue along MT2 and MT3 to enter new dedicated HSR platforms at grade at the center of San Jose Diridon Station (Figure 2-40). HSR platforms would be extended south to provide 1,385-foot and 1,465-foot platforms and would be raised to provide level boarding with the HSR trains. The existing Santa Clara Street underpass would remain, but the track in the throat and yard would require modification. There would be no need for modifications to the VTA light rail.

Continuing south, the blended at-grade three-track alignment would remain in the Caltrain right-of-way through the Gardner neighborhood. The existing underpass at Park Avenue and the existing overpass at San Carlos Street would remain in place. Four-quadrant gates with channelization would be built at Auzerais Avenue and West Virginia Street. A new bridge for the blended HSR/MT3 track over I-280 would be built. The existing underpasses at Bird Avenue and Delmas Avenue would be reconstructed, as would the rail bridge overpasses. New standalone rail bridges over Prevost Street, SR 87, the Guadalupe River, and Willow Street would be built for MT3. MT1 and MT2 would remain on the existing structures. The existing Tamien Caltrain Station would remain in place.

There would be freight track changes at the following locations:

- A new rail bridge over West Taylor Street
- Four-quadrant gates at Auzerais Avenue and West Virginia Street
- Freight track shifted north and east from West Virginia Street to Delmas Avenue
- New rail bridge over Bird Avenue and Delmas Avenue

Two track modifications in this subsection could have impacts on environmental resources:

- New freight track MT0 along the east side of the alignment from Emory Street to San Jose Diridon Station
- MT1 (nonelectrified freight track) shifted east

To allow for single tracking during construction by VTA light rail, Alternative A would install a new crossover with powered switches south of Tamien Station. Power would be provided to existing switches for the four crossovers at the diamond north of the Virginia VTA Station, as well as to the existing crossover south of Tamien. Alternative A would include signaling for these powered switches.

### **Diridon Design Variant**

The Authority has developed a design variant within the San Jose Diridon Station Approach Subsection that is intended to optimize train speed. The design variant would allow for higher speeds in the approaches to and through the San Jose Diridon Station than the preliminary engineering design for Alternative A would provide. The preliminary engineering design for Alternative A is based on the PCEP track geometry and restricts speeds in the approaches to and

through the station to 15 mph. The Diridon Design Variant would reduce the curvature in the alignment north of the San Jose Diridon Station between Julian Street and Santa Clara Street and from the south end of the station to San Carlos Street. The Diridon Design Variant would also modify the design of the San Jose Diridon Station platforms, providing for increased speeds of 40 mph, which is comparable to the design speeds provided by Alternative B.

### ***Roadway, Bridge, and Ramp Modifications***

Roadway, bridge, and freeway ramp modifications would be necessary at certain locations along the subsection. These are described in Volume 2, Appendix 2-A.

### ***Safety and Security Modifications to the Right-of-Way***

To improve safety, four-quadrant gates and median barriers would be installed at two at-grade crossings: Auzerais Avenue and West Virginia Street. Both crossings would use Application A (Table 2-14 and Figure 2-12). Fencing of the Caltrain right-of-way would be installed where fencing is not already present.

### ***Traction Power, Train Control, and Communications Facilities***

HSR would use the existing ATC sites included as part of the Caltrain PCEP. One standalone communications radio site would be built at one of two locations, both south of Scott Boulevard along the east side of the Caltrain corridor.

#### **2.6.2.5 Alternative B**

Alternative B would modify approximately 19.8 to 21.6 miles of existing Caltrain track, predominantly within the existing Caltrain right-of-way, build the West Brisbane LMF and a four-track passing track, modify 12 existing stations or platforms to accommodate HSR, and install safety improvements and communication radio towers. Table 2-17 summarizes the alternative's design features, followed by a more detailed description by subsection.



**Table 2-17 Summary of Design Features for Alternative B**

Feature	Alternative B (Viaduct to I-880)	Alternative B (Viaduct to Scott Boulevard)
Length of existing Caltrain track (miles) <sup>1</sup>	48.9	48.9
Length of modified Caltrain track (miles) <sup>1</sup>	19.8	21.6
Length of track modification <1 foot (miles) <sup>1</sup>	4.5	5.3
Length of track modification >1 foot and <3 feet (miles) <sup>1</sup>	1.9	1.9
Length of track modification > 3 feet (miles) <sup>1</sup>	13.4	14.4
Length of OCS pole relocation (miles) <sup>1, 2</sup>	15.3	16.3
Includes additional passing tracks	Yes	Yes
LMF	West Brisbane	West Brisbane
Modified stations		
Modifications to HSR stations	4th and King Street, Millbrae, San Jose Diridon	
Modifications to Caltrain stations due to the LMF	Bayshore (relocated)	
Modifications to Caltrain stations due to track shifts	San Bruno; Santa Clara (Alt B [Scott]); College Park (Alt B [I-880])	
Modifications to Caltrain stations to remove hold-out rule	Broadway, Atherton	
Modifications to Caltrain stations due to the passing tracks	Hayward Park; Hillsdale; Belmont; San Carlos (relocated)	
Number of modified or new Caltrain structures <sup>3</sup>	37	37
New structures	3	2
Modified structures	20	19
Replaced structures	8	10
Affected retaining walls	6	6
Profile in San Jose Diridon Station Approach Subsection		
At grade (miles)	0.9	0.4
Retained fill (miles)	0.2	0.1
Elevated (miles)	3.1	5.5
Number of at-grade crossings with safety modifications (e.g., four-quadrant gates, median barriers)	38	38
Length of new perimeter fencing	13.5	14.4
Communication radio towers	23	23

Sources: Authority 2019a, 2019b

HSR = high-speed rail

LMF = light maintenance facility

OCS = overhead contact system

<sup>1</sup> Lengths shown are guideway mileages.

<sup>2</sup> OCS pole relocations are assumed for areas with track shifts greater than 1 foot.

<sup>3</sup> Structures include bridges, grade separations such as pedestrian underpasses and overpasses, tunnels, retaining walls, and culverts.

### San Francisco to South San Francisco Subsection

The Alternative B characteristics in this subsection would be predominantly the same as those described for Alternative A in Section 2.6.2.4, with the exception of the Brisbane LMF. Siting the LMF on the west side of the Caltrain corridor (West Brisbane LMF) would require different track, roadway, and Bayshore Station modifications than described for Alternative A. Locations of track modifications, safety and security improvements, and communication radio towers in this subsection are illustrated on Figure 2-42.

### ***West Brisbane Light Maintenance Facility***

The West Brisbane LMF would be built south of the San Francisco Caltrain tunnels on approximately 110 acres west of the Caltrain corridor. Direct mainline track access would be along double-ended yard leads that would cross over the mainline track on aerial flyover and would enable north and south movements. The four existing mainline tracks would be shifted west by up to 16.5 feet, and new yard leads connecting to the West Brisbane LMF would be built east and west of the existing tracks. The yard leads east of the existing tracks would cross over the realigned four-track alignment on an aerial flyover to avoid train operations on the mainline track, converging with the yard leads on the west side of the track alignment. Transition tracks (approximately 1,400 feet long) would allow trains to reduce or increase speed when entering or exiting the LMF.

The West Brisbane LMF (Figure 2-43) would include a maintenance yard with 17 yard tracks parallel to a runaround track and a maintenance building with shop tracks. A power generator, sewage system, cistern, collection point, and electrical substation would be north of the maintenance building. A 400-space surface parking lot would be provided west of the maintenance building with truck and vehicle access to Industrial Way, which parallels and connects to Bayshore Boulevard.

Track modifications associated with the West Brisbane LMF would require relocating the Tunnel Avenue overpass, widening the bridge crossing Guadalupe Valley Creek in Brisbane, relocating CP Geneva at its intersection with Valley Drive, and providing a roadway extension connecting Valley Drive to Old Country Road. The widened Guadalupe Valley Creek Bridge would support the West Brisbane LMF lead tracks where they cross the creek. Track modification near CP Geneva could require relocating the overhead signal pole.

### ***Track and Station Modifications***

Track and station modifications in the San Francisco to South San Francisco Subsection for Alternative B (Figure 2-42) would predominantly be associated with the West Brisbane LMF. The realignment of the mainline tracks for the West Brisbane LMF would require relocation of the Bayshore Caltrain Station and removal of the existing Bayshore Station pedestrian overpass. The Bayshore Caltrain Station and associated surface parking lot, southbound platform, and a new pedestrian overpass would be reconstructed approximately 0.2 mile south of the existing station (inset on Figure 2-42). The new pedestrian overpass would provide access to the reconstructed station by connecting to Tunnel Avenue on the east and the planned local roadway network envisioned in the *Draft Brisbane Baylands Specific Plan* on the west (City of Brisbane 2011). The Bayshore Caltrain Station would be closer to the planned future Geneva Avenue extension, which would extend from Bayshore Boulevard to US 101.



Source: Authority 2019a

MAY 2019

**Figure 2-42 San Francisco to South San Francisco Subsection—Alternative B**

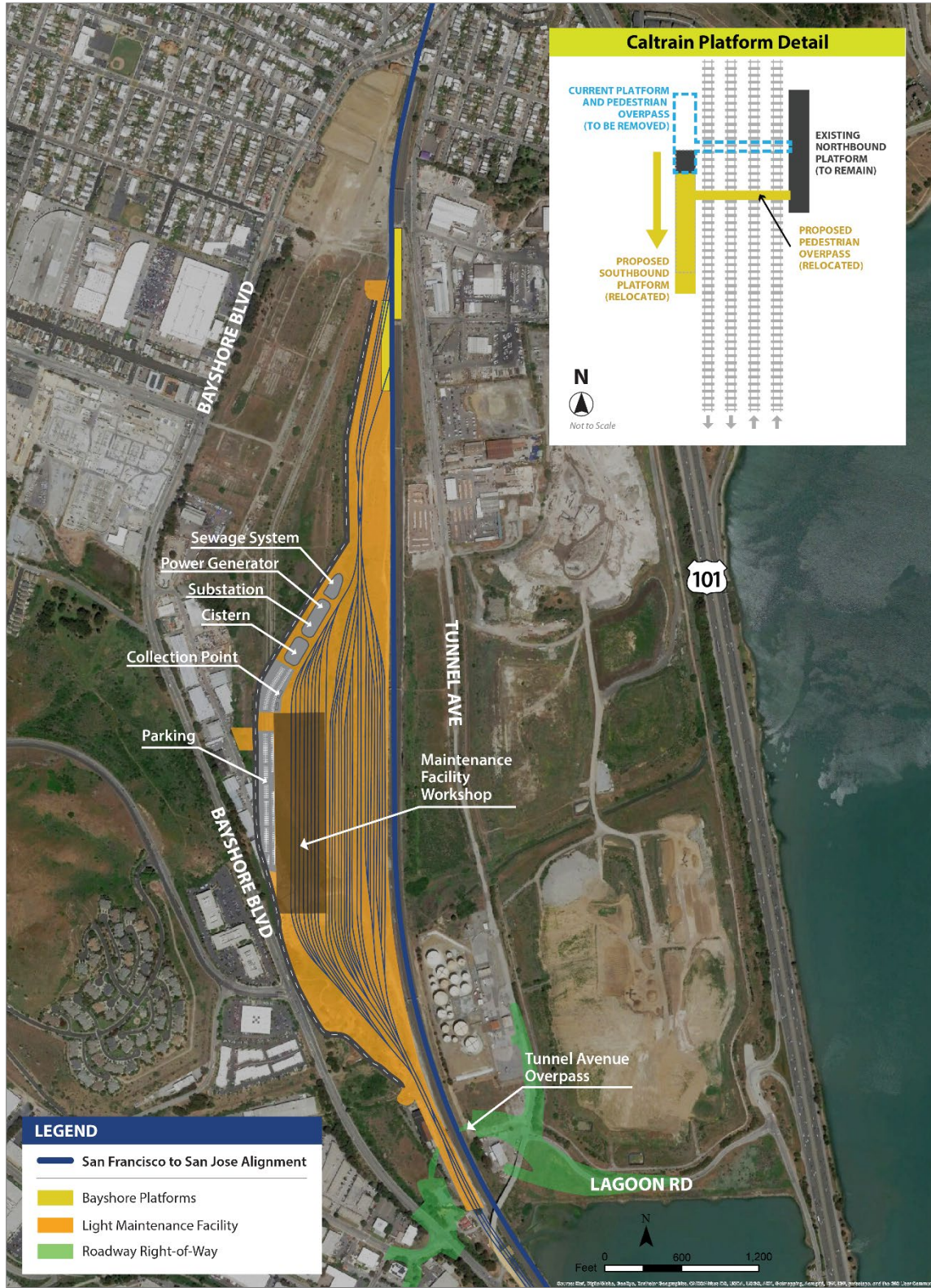

Source: Authority 2019a

SEPTEMBER 2018

Figure 2-43 West Brisbane Light Maintenance Facility Layout

### San Bruno to San Mateo Subsection

The characteristics of the San Bruno to San Mateo Subsection of Alternative B would be the same as those described for Alternative A in the San Bruno to San Mateo Subsection. The track and station modifications, safety and security improvements, Millbrae Station, and communication radio towers in this subsection are illustrated on Figure 2-33.

### San Mateo to Palo Alto Subsection

In the San Mateo to Palo Alto Subsection, Alternative B would build a passing track through San Mateo and San Carlos and modify the Hayward Park, Hillsdale, Belmont and San Carlos Stations to accommodate the additional passing tracks. As illustrated on Figure 2-44 (northern portion) and Figure 2-38 (southern portion), this alternative would modify existing track, install four-quadrant gates at 15 existing at-grade crossings, and install 7 communication radio towers. The platforms at the existing Atherton Station would be modified to eliminate the hold-out rule. While the northern portion of this subsection (Figure 2-44) differs from Alternative A because of the passing track and associated track and station modifications, the characteristics of the southern portion of the San Mateo to Palo Alto Subsection would be the same as those described for Alternative A in the San Mateo to Palo Alto Subsection (Figure 2-38). Additional right-of-way would be required in San Mateo, Belmont, San Carlos, Redwood City, Menlo Park, and Palo Alto associated with four-quadrant gates, communication radio towers, passing tracks, and the reconfiguration or relocation of existing Caltrain stations.

### Passing Tracks

The approximately 6-mile-long passing track would extend through San Mateo, Belmont, San Carlos, and into the northern portion of Redwood City. South of Ninth Avenue in San Mateo, the two-track alignment would diverge to four tracks continuing at grade and on retained fill. The existing tracks would be realigned predominantly within the existing right-of-way to accommodate the new four-track configuration. Additional right-of-way would be required in some areas with particularly narrow existing rights-of-way or where curve straightening would be necessary to achieve higher speeds.

Beginning in Hayward Park north of the SR 92 crossing, the tracks on retained fill would be shifted up to 46 feet, requiring acquisition of additional right-of-way. New outboard platforms, a pedestrian underpass at the Hayward Park Caltrain Station, and a new structure south of the SR 92 overpass would be built to carry the reconfigured four tracks over the Borel Creek culvert. South of the Hayward Park Station, the passing tracks would use the infrastructure installed by the planned 25th Avenue Grade-Separation Project (see text box). A new retaining wall would be installed between SR 92 and Hillsdale Boulevard to match the elevation of the 25th Avenue Grade-Separation Project, along with new bridge structures for the two new tracks at 25th, 28th, and 31st Avenues. Additionally, a northbound Hillsdale Station platform would be built, eliminating some existing parking at the Hillsdale Station. At Hillsdale Boulevard, the existing underpass structure would be widened to accommodate the realigned tracks, along with widening of the existing Laurel Creek underpass to the south.

#### *25th Avenue Grade-Separation Project*

This grade-separation project, which is being undertaken by Caltrain in coordination with the City of San Mateo, would elevate the existing at-grade track between State Route 92 and Hillsdale Boulevard to provide a grade-separated undercrossing of 25th Avenue, build new east-west crossings under the track corridor at 28th and 31st Avenues, and relocate the Hillsdale Station. Construction is expected to be completed in 2020.

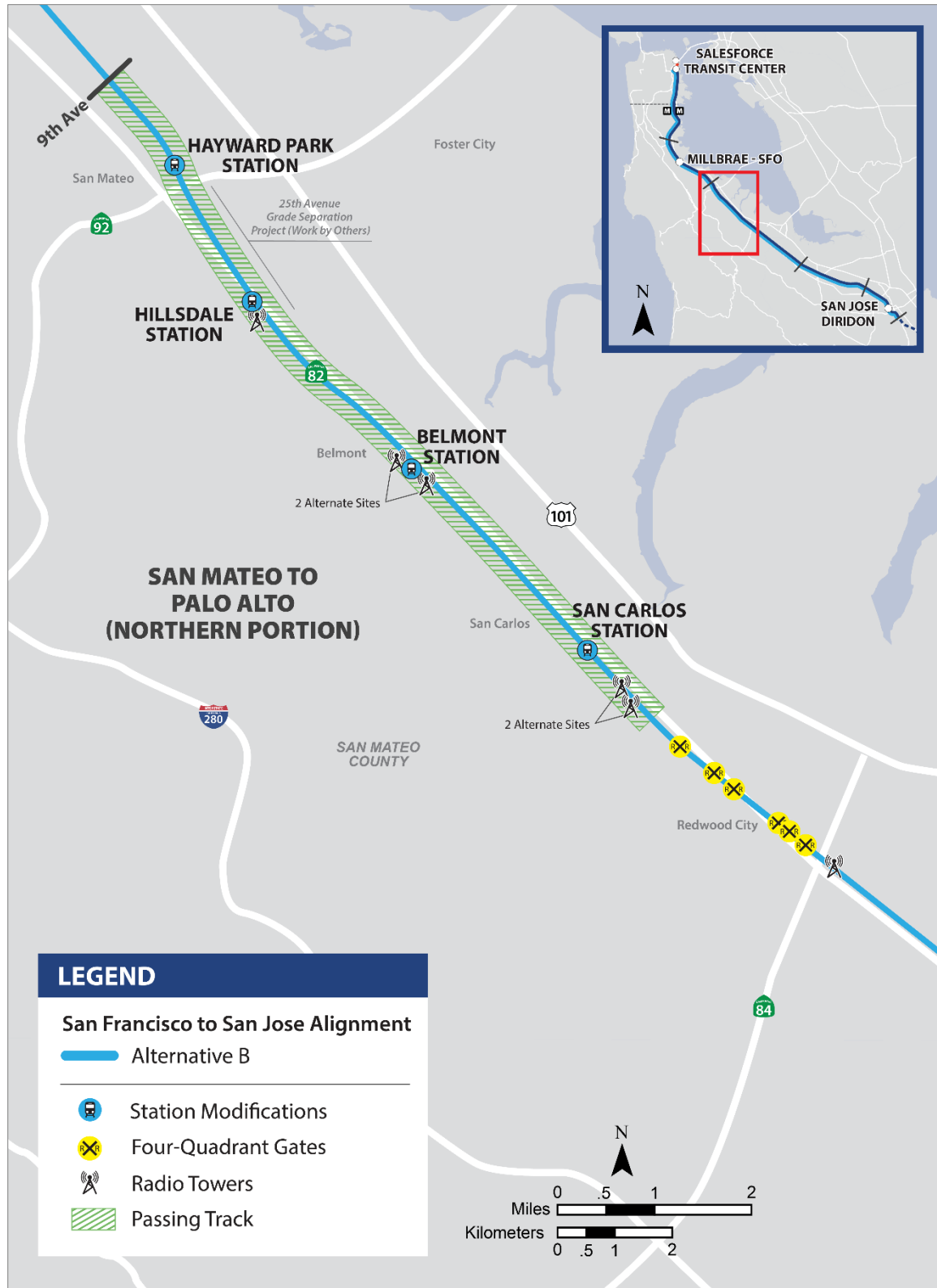

Source: Authority 2019a

MAY 2019

**Figure 2-44 San Mateo to Palo Alto Subsection (Northern Portion)—Alternative B**

South of Hillsdale Boulevard, the passing tracks would ascend to a four-track retained-fill section. Between Hillsdale Boulevard and Whipple Avenue, the following structures or facilities would be replaced or rebuilt: CP Ralston tie-in points, Belmont Station platforms, and San Carlos Station and platforms. The Belmont Station and platforms would be reconstructed to accommodate the new four-track configuration. The San Carlos Station and platforms would be relocated approximately 2,260 feet south of their currently location to Arroyo Avenue and a pedestrian underpass would be built. The following structures would be removed and replaced or modified: 42nd Avenue underpass, Belmont Caltrain Station pedestrian underpass, Ralston Avenue underpass, Harbor Boulevard underpass, F Street pedestrian underpass, Holly Street and San Carlos Station pedestrian underpass, Arroyo Avenue pedestrian underpass, Brittan Avenue, and Howard Avenue. South of Howard Avenue, Alternative B would descend to grade and converge back to a two-track configuration.

### **Track and Station Modifications**

The track and station modifications under Alternative B would vary from those described for Alternative A in the northern portion of the subsection between Ninth Avenue in San Mateo and Whipple Avenue in Redwood City. In this portion of the subsection, the addition of two passing tracks would result in modifications to the existing Hayward Park, Hillsdale, Belmont, and San Carlos Caltrain Stations. Alternative B would modify and realign station platforms at the Hayward Park Caltrain Station, build new platforms at the Hillsdale and Belmont Caltrain Stations, and relocate the San Carlos Caltrain Station approximately 2,260 feet south of its existing location (Figure 2-45).

South of Whipple Avenue, the track and station modifications in the southern portion of this subsection would be the same as those described for Alternative A. Safety-related modifications would be made to the Atherton Station, including platform upgrades that would eliminate the hold-out rule by extending the southbound platform and adding a second outboard platform to serve the northbound track (Figure 2-16).

### **Mountain View to Santa Clara Subsection**

The characteristics of the Mountain View to Santa Clara Subsection under Alternative B would be the same as those described for Alternative A. The locations for track modifications, safety and security improvements, and communication radio towers within this subsection are illustrated on Figure 2-38.

### **San Jose Diridon Station Approach Subsection**

The San Jose Diridon Station Approach Subsection, from Scott Boulevard in Santa Clara to West Alma Avenue in San Jose, would extend approximately 6 miles through Santa Clara and San Jose (Figure 2-40). The existing Caltrain track in this subsection consists of predominantly two-track and three-track at-grade alignment. South of De La Cruz Boulevard, UPRR tracks of the Coast Line from the northeast converge with the Caltrain corridor and continue south adjacent to the east side of the railroad corridor to the Santa Clara Caltrain Station. Between the College Park Caltrain Station and San Jose Diridon Station, Caltrain's CEMOF comprises three mainline tracks, a maintenance building, and nine yard tracks. San Jose Diridon Station includes five passenger platforms served by nine yard tracks along the west side of the station house. HSR would diverge from the Caltrain corridor at Park Avenue, just south of San Jose Diridon Station, returning to the Caltrain corridor at the north end of the Tamien Caltrain Station, which includes a passenger platform served by two tracks and a single through track.

Under Alternative B, one of two options would be selected: a viaduct from I-880 to an aerial San Jose Diridon Station (Viaduct to I-880) or a viaduct from Scott Boulevard to the station (Viaduct to Scott Boulevard).

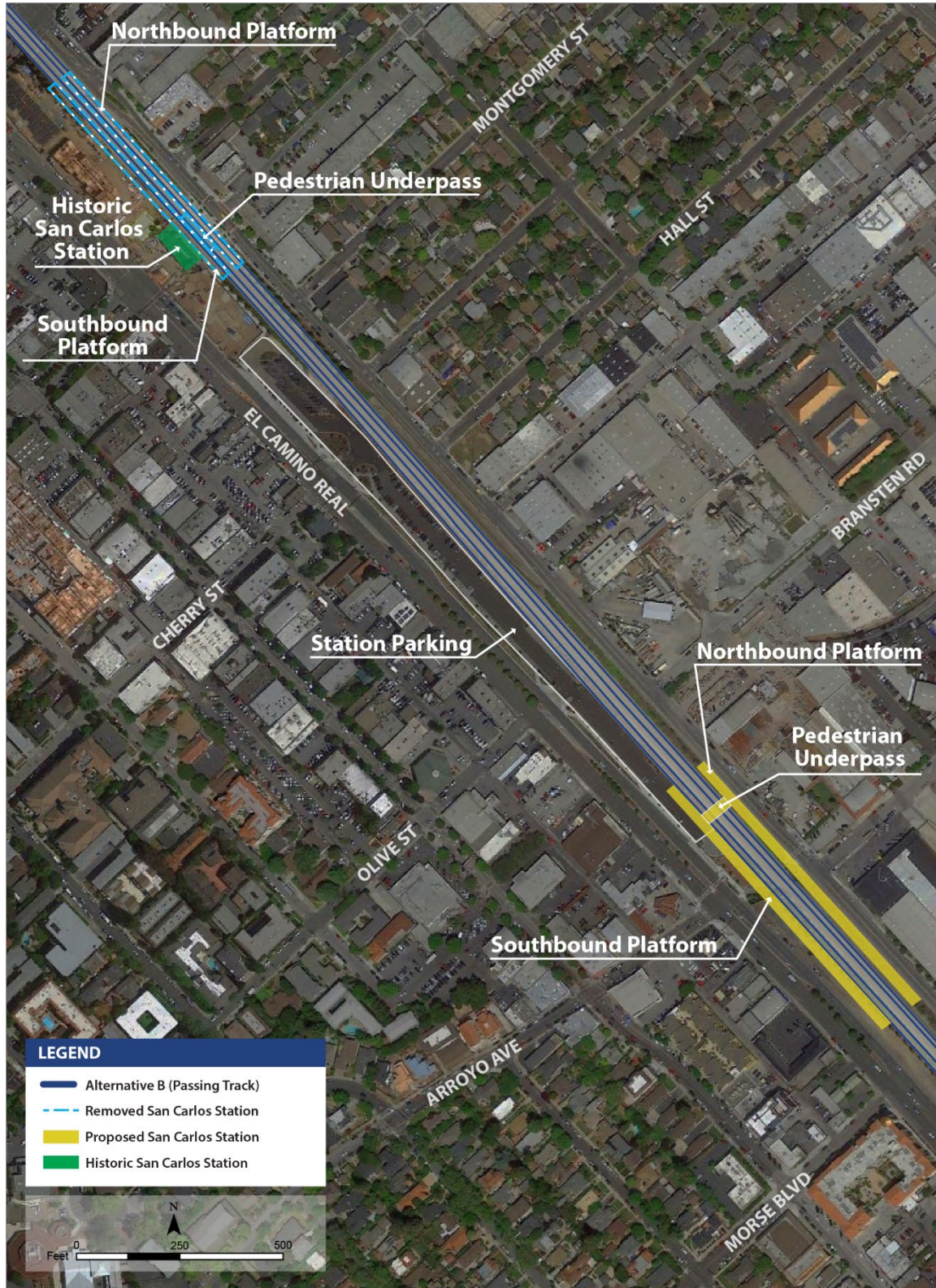

Source: Authority 2019a

SEPTEMBER 2018

Figure 2-45 San Carlos Station Relocation—Alternative B



**Station Modifications**

Under Alternative B (Viaduct to I-880), the Santa Clara Caltrain Station would remain unchanged and the College Park Station would have new northbound and southbound platforms and pedestrian undercrossings. Under Alternative B (Viaduct to Scott Boulevard), the Santa Clara Station northbound platform would be rebuilt to accommodate the supports for the HSR aerial structure and the College Park Caltrain Station would remain unchanged.

The San Jose Diridon Station would have the same design with both viaduct options. The station would entail a four-track aerial alignment over the existing station at approximately 62 feet to top of rail with 1,410-foot-long platforms above the existing Caltrain rail yard centered between Santa Clara Street and Park Avenue (Figure 2-46 and Figure 2-47). The existing historic train station would remain in place. The primary HSR station building would be built north of the existing station building, but it would continue to the south, wrapping around the existing Caltrain station building. The HSR station building would be accessed from the east at three entrances: the main entrance on the east side of the tracks north of the existing historic depot next to the future BART alignment; an entrance south of the existing historic Diridon station building; and an entrance on the east side, south of the Pacific Gas and Electric Company (PG&E) power station.<sup>20</sup> There would also be three entrances to the HSR station on the west side of the tracks: a north entrance at the end of White Street and two entrances on Laurel Grove Lane, one north and one south. The aerial station would require viaduct columns within the PG&E substation. The HSR station building would encompass 99,289 square feet with a 4,440-square-foot substation and systems building. The concourse would consist of a mezzanine level above the existing Caltrain tracks and below the HSR platforms, with three east-west connections across the tracks at the north, south, and middle.

Existing parking spaces (226) at Cahill Street would be displaced and replaced 1:1 with new parking areas at Cahill and Park Streets and at Stockton and Alameda Streets. As described in Section 2.6.2.4, HSR parking demand of 1,050 spaces in 2040 would be met by commercially available parking downtown as well as at SJC. HSR riders would be able to walk or take a shuttle, such as the City of San Jose’s DASH, from parking downtown or adjacent to the station.

The existing off-site bus transit center at the San Jose Diridon Station would be relocated to an on-street facility on Cahill, Stover, and Crandall Streets. Street improvements would include reconfiguring and extending Cahill Street from Santa Clara Street to Park Avenue, and converting Cahill, Stover, and Crandall Streets to a transit street with 12 to 15 bus stops. Montgomery Street would be reconfigured to provide curb space for a bus layover. A pick-up/drop-off zone of 1,900 square feet would be provided. A new two-way bicycle path would be installed on the east side of Cahill Street. A 4,000-square-foot bicycle facility would be built. New signals and pedestrian crossings would be developed at Cahill and Park, Otterson, Stover, West San Fernando, and Crandall Streets.

---

<sup>20</sup> The PG&E substation is not part of the project footprint.

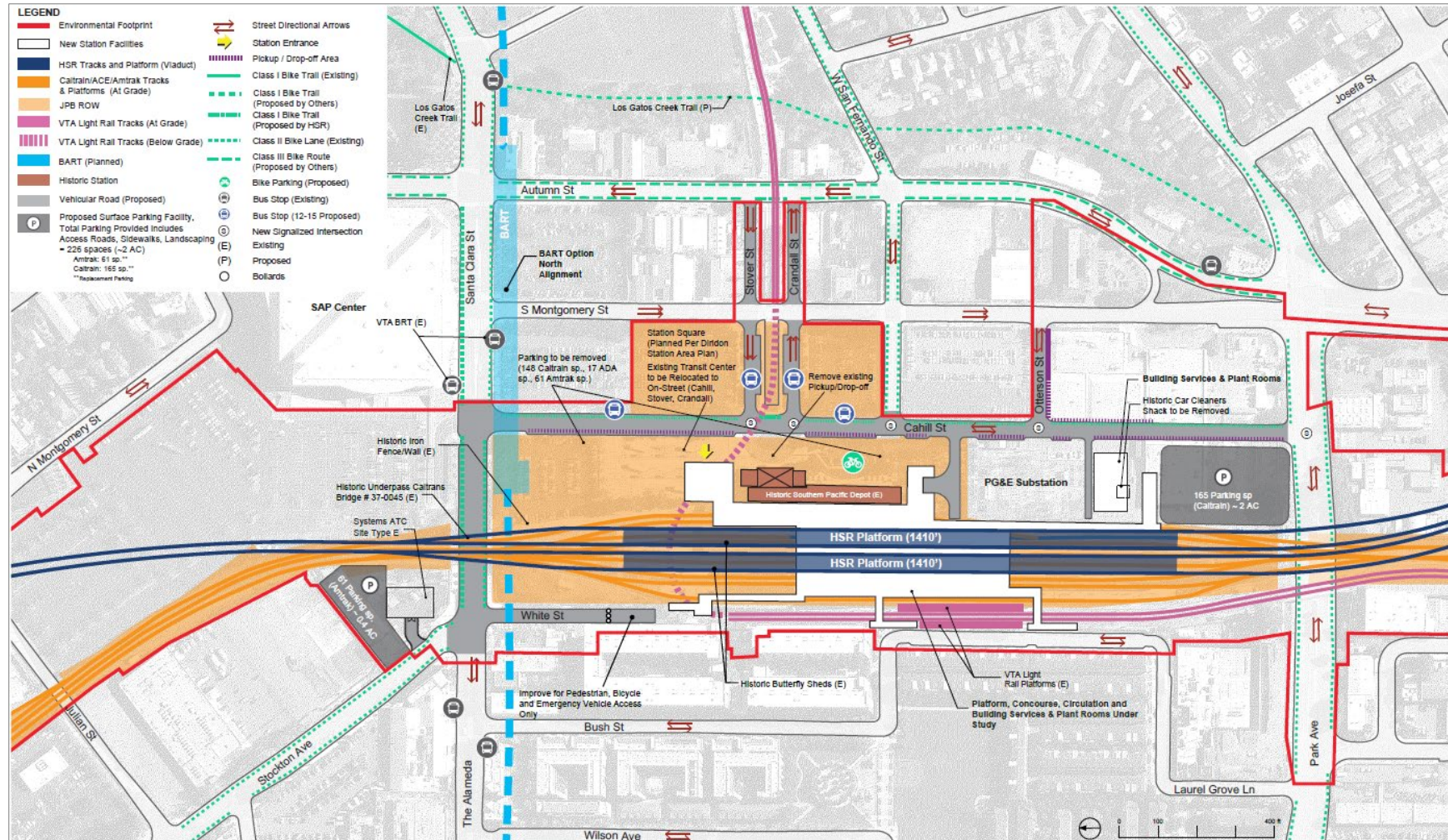

Source: Authority 2019b

JANUARY 2019

Figure 2-46 Conceptual Aerial San Jose Parking Diridon Station Plan

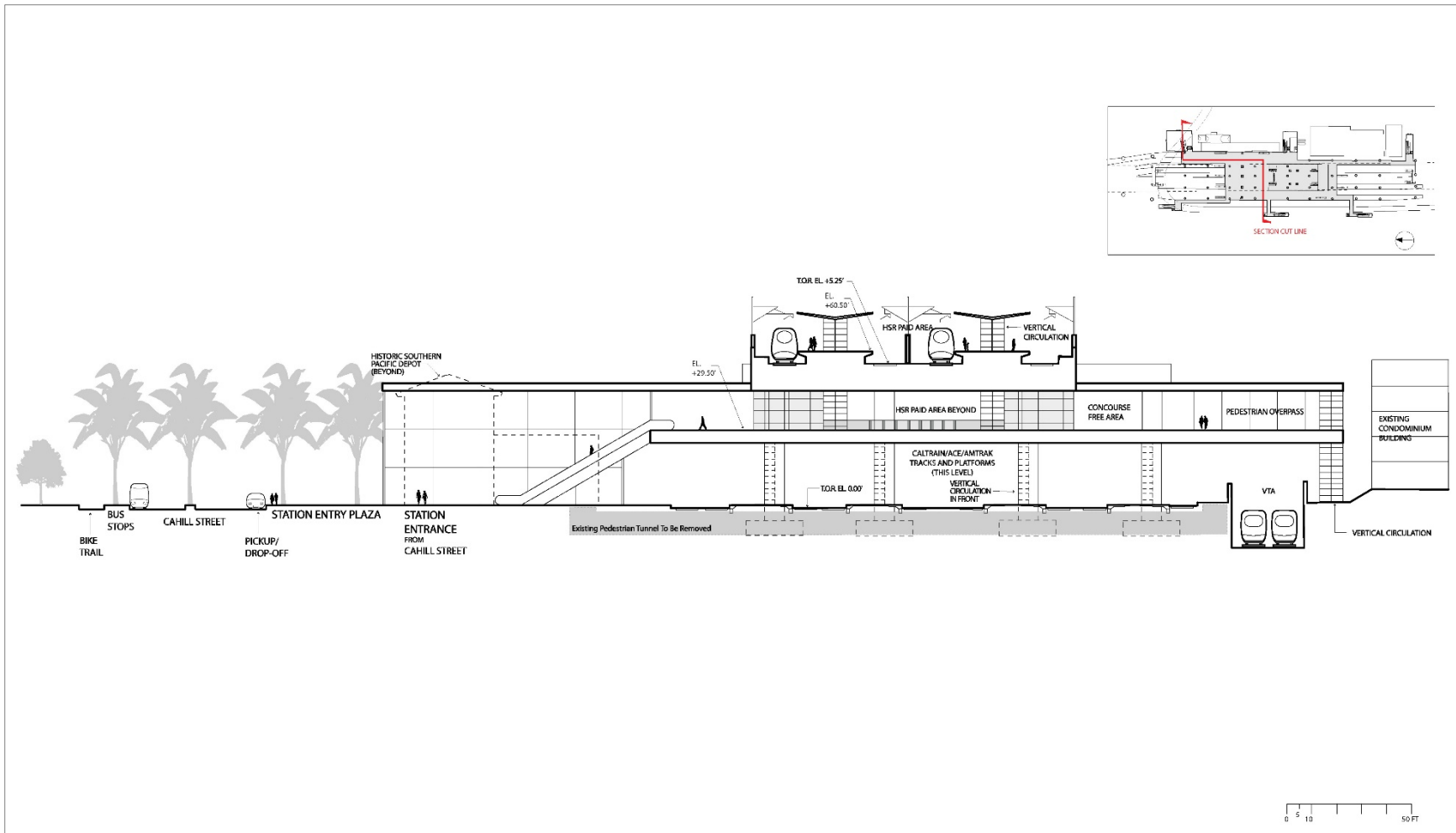

Source: Authority 2019b

JANUARY 2019

Figure 2-47 Conceptual Aerial San Jose Diridon Station Cross Section



Other rail operators in the station area are Caltrain, ACE, Amtrak, VTA light rail, and future BART. VTA has plans to build new light rail station platforms as a separate project, and BART plans to extend service from the Berryessa Station to Santa Clara with a stop at Diridon by 2026.

### **Track Modifications**

Two options are available for the alignment from the beginning of the subsection at Scott Boulevard to the San Jose Diridon Station. Beyond the station, there would be a single alignment under Alternative B.

#### **Viaduct to I-880**

Between Scott Boulevard and Benton Street, HSR would operate on blended service tracks, entailing several minor track modifications of less than 1 foot between Scott Boulevard and I-880. The blended service tracks are owned by the PCJPB.

Beginning at I-880 on the southbound approach to West Hedding Street, Caltrain tracks would be realigned to accommodate the HSR tracks. Dedicated HSR tracks would diverge from the Caltrain MT2 and MT3 tracks and continue south along the north side of the existing Caltrain corridor. To accommodate the new track configuration, the West Hedding Street roadway overpass would be replaced with a new overpass bridge that would also pass over Stockton Avenue. The UPRR/Caltrain MT1 tracks would be shifted east by up to 226 feet.

Southeast of West Hedding Street, the dedicated HSR tracks would transition from a two-track at-grade configuration to retained fill and finally to a two-track aerial profile. The HSR alignment would begin the viaduct to I-880 by rising on embankment to an approximately 70-foot-high aerial structure. A new bridge structure would be built to carry the realigned UPRR/Caltrain MT2 tracks over the West Taylor Street underpass. University Avenue would become a cul-de-sac. The HSR viaduct would also cross over West Taylor Street, then shift horizontally a maximum of 500 feet east of the existing UPRR/Caltrain mainline tracks to maintain high-speed track curvature.

Both legs of the UPRR Warm Springs Subdivision Lenzen Wye would be relocated, and North Montgomery Street would be extended north of the alignment of Lenzen Avenue almost to the former Lenzen Wye to maintain property access beneath the 60-foot-high HSR viaduct. The freight track would be shifted up to 64 feet at the Lenzen Wye. The HSR viaduct would cross over Cinnabar Street, both legs of the relocated Lenzen Wye and North Montgomery Street, West Julian Street, and West Santa Clara Street while curving west toward the UPRR/Caltrain mainline tracks to enter a new aerial dedicated HSR station at San Jose Diridon Station.

Continuing on an aerial structure, the alignment would diverge from the Caltrain right-of-way south of the San Jose Diridon Station HSR platforms by turning sharply east at the Park Avenue overcrossing. The HSR aerial structure would cross over Los Gatos Creek and San Carlos Street, then over Royal Avenue and the intersection of Bird Avenue and Auzerais Avenue, then over the I-280/SR 87 interchange. Continuing south along the east side of SR 87, the HSR aerial structure would cross over West Virginia Street and the Guadalupe River Trail, then over the Caltrain rail bridge, the Guadalupe River, and Willow Street. The HSR aerial structure would continue south over the Tamien Caltrain Station (on straddle bents) and then on an alignment between Tamien Station and the SR 87 freeway to West Alma Avenue.

#### **Viaduct to Scott Boulevard**

Under this option the alignment would begin at Scott Boulevard at grade in blended service with Caltrain. Approximately 300 feet south of Scott Boulevard, the HSR tracks would separate from the Caltrain tracks and begin ascending to embankment and then to the 50-foot-tall dedicated viaduct at Main Street. The viaduct under this option would have a wider footprint than the viaduct to I-880, requiring more curve straightening of the Caltrain tracks north of I-880. At the Lafayette Street crossing, an underpass would replace the existing pedestrian overpass. The existing De La Cruz Boulevard overcrossing would be replaced with an undercrossing to enable the HSR aerial structure to cross 43 feet high over De La Cruz Boulevard, the relocated UPRR MT1 and two industry tracks, and the Santa Clara Caltrain Station. The UPRR tracks would be relocated south of De La Cruz to pass around the east side of the new Santa Clara Station northbound platform, and would connect to the existing tracks south of I-880. South of Santa Clara Station,

the three relocated UPRR tracks would cross under the HSR viaduct so that all Caltrain and UPRR tracks would be west of the HSR viaduct. The HSR viaduct would then ascend to approximately 68 feet to cross over I-880.

Farther south, the existing West Hedding Street roadway overcrossing would be replaced by an undercrossing under the rail corridor. A short section of retained fill would be used to support the tracks over the future BART to San Jose tunnel. The intersection of Stockton Avenue and University Avenue would be replaced by cul-de-sacs. Emory Street would be a new cul-de-sac on the north side of HSR. The curve from westbound West Taylor Street to northbound Chestnut Street would be realigned for the HSR crossing over West Taylor Street; the alignment would then ascend to cross over Cinnabar Street. The UPRR Warm Springs Subdivision Lenzen Wye would be relocated to the southwest. Like the Viaduct to I-880 option, the Viaduct to Scott Boulevard option would shift the freight tracks at the Lenzen Wye; however, the curves would be different.

North Montgomery Street would be extended to Cinnabar Street to maintain property access beneath the 68-foot-high HSR viaduct. The alignment would curve west toward the UPRR/Caltrain mainline tracks before crossing over the western part of the SAP Center parking lot, then over West Santa Clara Street to enter the new dedicated HSR aerial platforms at the San Jose Diridon Station. Between San Jose Diridon Station and West Alma Avenue, the Viaduct to Scott Boulevard option would be identical to the Viaduct to I-880 option.

### ***Roadway, Bridge, and Ramp Modifications***

Roadway, bridge, and freeway ramp modifications would be necessary at certain locations along the subsection. These are described in Volume 2, Appendix 2-A.

### ***Safety and Security Modifications to the Right-of-Way***

The bulk of the alignment in this subsection would be dedicated, grade-separated track. There would be no at-grade crossings.

### ***Traction Power, Train Control, and Communications Facilities***

One new TPSS would be built in this subsection on the east side of the Caltrain corridor south of I-880 in San Jose (just southeast of the I-880 overcrossing). The TPSS would be connected to two new gas-insulated substation breaker-and-a-half bays. The bays would be installed within the fence line of the PG&E FMC substation, just north of the I-880 overcrossing, by means of an aerial double-circuit 115-kilovolt tie-line.

Under Alternative B (Viaduct to I-880), there would be six ATC sites between I-880 in San Jose and the I-280 and SR 87 interchange as follows:

- Two sites near the TPSS facility
- One site just north of the San Jose Diridon Station
- Three sites between Park Avenue and the proposed HSR crossing of SR 87

Under Alternative B (Viaduct to Scott Boulevard), there would also be six ATC sites within this subsection as follows:

- One site at Scott Boulevard
- One site at Main Street
- One site just north of the San Jose Diridon Station
- Three sites between Park Avenue and the proposed HSR crossing of SR 87

With the Viaduct to I-880 option, there be one standalone communications radio tower at one of two locations, both south of Scott Boulevard along the east side of the Caltrain corridor. With the Viaduct to Scott Boulevard option, there would be no standalone communication radio sites within this subsection.

## 2.7 Ridership

### 2.7.1 Travel Demand and Ridership Forecasts

Ridership forecasts were prepared to support ongoing planning for the HSR system and the analysis in this Draft EIR/EIS. The forecasts were developed for the 2016 Business Plan by Cambridge Systematics, Inc. using a refined ridership and revenue model, Business Plan Model Version 3. The ridership forecasts for the 2016 Business Plan were based on three distinct implementation scenarios: (1) a Valley-to-Valley scenario, in which the Silicon Valley to Central Valley Line opens in 2025 and (2) a Valley-to-Valley extended scenario, in which the Silicon Valley to Central Valley Line opens with an extension to San Francisco and Bakersfield in 2025, and (3) the Phase 1 HSR scenario with HSR operations from Los Angeles to San Francisco starting in 2029. For each scenario, the Business Plan presented high, medium, and low forecasts, reflecting a range of probabilities.<sup>21</sup> Forecasts for each scenario were presented for a range of years from 2025 through 2060. The forecasts in the Business Plan were developed by Cambridge Systematics, which also prepared technical reports supporting those forecasts.

The ridership forecasts presented in this Draft EIR/EIS are based on the Valley-to-Valley implementation scenario for 2029 and the Phase 1 HSR scenario for 2040 from the 2016 Business Plan.<sup>22</sup> Both the medium and high ridership forecasts from the 2016 Business Plan are used in this EIR/EIS. In general, the medium ridership forecast provides for a conservative analysis of project benefits, whereas the high ridership forecast provides for a conservative analysis of adverse impacts.<sup>23</sup> For the year 2040 Phase 1 HSR scenario, the 2016 Business Plan forecasts projected 42.8 million passengers under the medium ridership scenario, and 56.8 million passengers under the high ridership scenario (Authority 2016e). The 2040 forecasts correspond to the horizon year used for impacts analysis in this EIR/EIS, and therefore the Draft EIR/EIS focuses on the 2040 forecasts (Table 2-18).

**Table 2-18 High-Speed Rail System Ridership Forecasts from the 2016 Business Plan (in millions per year)**

Forecasts	Silicon Valley to Central Valley Line (2025)	Phase 1 (2029)	Phase 1 (2040)
Medium	3.0	19.3	42.8
High	4.2	26.0	56.8

Source: Authority 2016e

The Business Plan Model Version 3 refined the previous Version 2 model by fully integrating data gathered from the more recent stated preference surveys. The model was further refined by incorporating a new variable that reduced the number of trips involving a relatively long trip to or from the HSR station combined with a relatively short trip on the HSR line itself. The variable reflected the disadvantage and low likelihood of those types of trips. In addition, several other small adjustments related to auto costs and transit networks were made to the model to produce updated forecasts. Additional details regarding the 2016 Business Plan modeling and forecasts are included in the *California High-Speed Rail 2016 Business Plan Ridership and Revenue Forecasting: Technical Supporting Document* (Authority 2016e).

<sup>21</sup> The development of the 2016 Business Plan forecasts included a probability assessment, which was generated through an analytical technique known as Monte Carlo simulations. The Monte Carlo analysis involves running thousands of simulations to assess the likelihood that a given outcome would occur.

<sup>22</sup> Although the 2016 Business Plan presumed the Valley-to-Valley scenario would be implemented in 2025, the 2018 Business Plan has identified that the Valley-to-Valley scenario would commence operations in 2029. As a result, the 2025 ridership from the 2016 Business Plan is presumed in this EIR/EIS to occur in 2029, not 2025.

<sup>23</sup> For additional detail regarding the use of medium and high ridership forecasts in this EIR/EIS, refer to Section 3.1, Introduction.

This range of ridership forecasts reflects the development of certain aspects of the HSR system's design and certain portions of the environmental analysis, described in more detail in the following subsections. Because the ultimate ridership of the HSR system would depend on many uncertain factors, such as the price of gasoline and population growth, the HSR system described in this document has been designed to accommodate the broad range of ridership expected over the coming decades.

Since the 2016 Business Plan forecasts were developed, the Authority has adopted its 2018 Business Plan, which was accompanied by updated forecasts (Authority 2016e, 2018a). The 2016 and 2018 Business Plan ridership forecasts were developed using the same travel forecasting model; the forecasts differ due to changes in the model's inputs, including the HSR service plan, demographic forecasts, estimates of automobile operating costs and travel times, and airfares. The medium ridership forecast for 2040 decreased by 6.5 percent, from 42.8 to 40 million, and the high ridership forecast decreased by 10.1 percent, from 56.8 to 51.6 million. In addition, the 2018 Business Plan assumes Valley-to-Valley service would commence in 2029 (not 2025 as in the 2016 Business Plan) with an opening year of 2033 rather than 2029 for the full Phase 1 system.

The Authority released a Draft 2020 Business Plan in February 2020 for public review and comment. The plan's final adoption is expected at the April 2020 Board meeting for submittal to the Legislature by May 1, 2020. The 2020 Business Plan forecasts were developed using the same travel forecasting model as the 2016 and 2018 Business Plans, updated for population and employment forecasts. The 2020 Business Plan Phase 1 medium ridership forecast for 2040 is 38.6 million, and the high is 50.0 million (Authority 2020a).

To the extent that the lower ridership levels projected in the 2018 Business Plan or the 2020 Business Plan would result in fewer trains operating in 2040, the impacts associated with the train operations in 2040 would be somewhat less than the impacts presented in this Draft EIR/EIS and the benefits accruing to the project (e.g., reduced vehicle miles traveled, reduced greenhouse gas [GHG] emissions, reduced energy consumption) also would be less than the benefits presented in this Draft EIR/EIS. As with the impacts, the benefits would continue to build and accrue over time and would eventually reach the levels discussed in this Draft EIR/EIS for the Phase 1 system.

## **2.7.2 Ridership and High-Speed Rail System Design**

The HSR system analyzed in this Draft EIR/EIS reflects the fact that the system is a long-term transportation investment for the State of California. It is being designed with state-of-the-art infrastructure and facilities that would serve passengers over many decades. While most of the infrastructure components are designed and built for full utility, certain components are more flexible and can change and adapt to meet ridership as it grows over time.

While the Authority and FRA weighed ridership and revenue potential in evaluating alignment and station alternatives in the Tier 1 Program EIR/EIS documents and Tier 2 alternatives screening, the primary driver influencing design of the HSR system is not the total forecasted annual ridership but rather the performance objectives and safety requirements stipulated by the Authority, FRA, the U.S. Department of Transportation, and the regional transportation partners—including Caltrain, Amtrak, and other operators—whose systems would either use the shared segments of the HSR alignment (blended corridor) or provide connections to the high-speed service.

In keeping with these objectives and requirements, as well as the blended system parameters, the alignment in this Project Section comprises a predominantly two-track system regardless of total annual ridership. Track geometry and profile, power distribution systems, train control/signal systems, type of rolling stock, and certain station elements would be the same in both the dedicated and blended corridors regardless of how many riders use the HSR system. The locations of the heavy and light maintenance facilities also follow the mandates stipulated by technical operating requirements rather than ridership.



While the performance objectives and safety requirements are the main factors influencing HSR system design, ridership does influence some aspects of the system’s design, including the size of the heavy and light maintenance facilities. The sizes of these facilities are based on the 2040 high ridership forecast so that these facilities would be sufficient to accommodate maximum future needs. This approach is consistent with general planning and design practices for large infrastructure projects in which resilience and adaptability are incorporated by acquiring enough land for future needs up front instead of trying to purchase property at a later date when it may no longer be available or may be impractical to acquire. The use of ridership forecasts facilitates the early phases of maintenance facility construction as well as subsequent expansion of the facility as fleet size and maintenance requirements grow.

Forecasted annual ridership and peak-period ridership also play a role in determining the size of some station components, such as the size of the public accessway/egressway to the HSR system. The 2040 high ridership forecast formed the basis for the conceptual service plan, which in turn influenced station site planning by designing station facilities to be sufficient to accommodate the anticipated increase over time of HSR use.

The 2040 high ridership scenario was also used, along with local conditions, to determine the maximum amount of parking needed at each station. Parking demand and supply were analyzed by considering many factors—including ridership demand, station area development opportunities, and availability of alternative multimodal access improvements—to inform the size of the parking facilities at each station and the anticipated schedule for the phased implementation of these facilities. The use of the 2040 high ridership scenario provides flexibility to change or even reduce the amount of station parking as these factors become more defined and resolved over time (see Section 2.4.3, Stations, for additional information).

### **2.7.3 Ridership and Environmental Impact Analysis**

The forecasts of annual HSR ridership play a role in the analysis of environmental impacts and benefits related to traffic, air quality, noise, and energy. This Draft EIR/EIS uses both the medium and high ridership forecast for analyzing potential adverse environmental impacts and environmental benefits of operating the HSR system. The use of ridership forecasts is discussed in more detail in Section 3.1, Introduction.

### **2.7.4 Ridership and Station Area Parking**

HSR system ridership, parking demand, parking supply, and development around HSR stations are intertwined and would evolve as ridership increases from the 3 million to 4.2 million anticipated at the start of revenue service in 2029 to as many as 56.8 million passengers in 2040 when the HSR system is in full operation. To attract, support, and retain high ridership levels, the Authority is working with transportation service providers and local agencies to promote TOD around HSR stations and expand multimodal access to the HSR system.

These activities would be implemented at various times reflecting the station area and transit system development plans. Some cities and regions would be able to develop their station areas and local transit systems at a faster rate than others by the 2029 start-up of HSR revenue service and before 2040 when the HSR system would be fully operational. Parking demand and supply at each station would also be affected by technological advances, such as multimodal trip planning/payment software and autonomous vehicles, as well as changes in the bundle of services available to consumers, such as ride-hailing services and bike- and car-sharing programs.

Research suggests that the percentage of transit passengers arriving at and departing from transit stations by car and needing parking accommodations decreases as development and population around the stations increases. The Authority has adopted station-area development policies that recognize the inverse relationship between parking demand and HSR station-area development. In keeping with these policies, the Authority is working with regional planners and planners in the station cities to maximize the success of the HSR system by locating stations in areas where there is, or would be, a high density of population, jobs, commercial development,

entertainment venues, and other activities that generate trips. Encouraging development in high-density areas around HSR stations would allow the Authority to attain its dual goal of supporting system ridership while reducing parking demand.

However, development around HSR stations would not occur immediately. Although the HSR system would be a catalyst for development, the type, location, quantity, density, and timing of station-area development is dictated by local land use decisions and market conditions. The Authority would work in partnership with local governments and landowners to encourage complementary station-area development, exemplified by the station-area planning funding agreements it has provided to the City of San Jose, but its power in this regard is limited. Consequently, the factors that determine actual parking demand and supply are dependent primarily on local decisions and local conditions.

Because of the uncertainty regarding the need for station-area parking, this Draft EIR/EIS conservatively identifies parking facilities based on the maximum forecast for parking demand at each station, the local conditions affecting access planning, and practical means for delivering required parking. This approach identifies the upper range of actual needs and the maximum potential environmental impacts of that range.

The Authority, in consultation with local communities, would have the flexibility to make decisions regarding which parking facilities would be built initially and how additional parking can be phased in or adjusted depending on how HSR system ridership increases over time. For example, some parking facilities could be built at the 2029 project opening and subsequently augmented or replaced in whole or in part based on future system ridership, station-area development, and parking management strategies. A multimodal access plan would be developed prior to the design and construction of parking facilities at each HSR station. These plans would be prepared in coordination with local agencies and would include a strategy that addresses and informs the final location, amount, and phasing of parking at each station.

The Authority estimated rail, bus, auto, walk, and bike passenger access and egress trips for year 2040 for all stations with an additional year 2029 analysis for the 4th and King Street Station and the San Jose Diridon Station.<sup>24</sup> The auto mode share included estimates for pick-up and drop-off, drive and park, rental car and taxi/shuttle/transportation network company travel modes. Parking demand was estimated based on auto drive and park mode share. The proposed parking supply is based on project demand and local conditions in the surrounding station area. Existing on-site parking that would be displaced by the HSR station would be replaced at a 1:1 ratio.

The Authority, in consultation with local communities, would develop a multimodal access plan prior to the design and construction of station facilities at each HSR station. These plans would be prepared in coordination with local agencies and would include strategies that address and inform the location, amount, phasing, and management of parking at each station.

## 2.8 Operations and Service Plan

### 2.8.1 High-Speed Rail Service

The conceptual HSR service plan for Phase 1 describes service from Anaheim/Los Angeles through the Central Valley from Bakersfield to Merced and northwest into the Bay Area (Authority and FRA 2017c). Subsequent stages of the HSR system include a southern extension from Los Angeles to San Diego via the Inland Empire and an extension from Merced north to Sacramento.

---

<sup>24</sup> The Authority collected local station area data to prepare a Mode of Access Memorandum for each station. Data collection involved touring station areas, consulting local agencies, and reviewing local plans and policies. The memoranda were shared with the local jurisdictions in the station cities.

Train service would operate in diverse patterns between various terminals. Three basic service types are envisioned:

- Express trains, which would serve major stations only, providing fast travel times between Los Angeles and San Francisco during the morning and afternoon peak
- Limited-stop trains, which would skip selected stops along a route to provide faster service between stations
- All-stop trains, which would focus on regional service

The majority of trains would provide limited-stop services and offer a relatively fast run time along with connectivity among various intermediate stations. Numerous limited-stop patterns would be provided to achieve a balanced level of service at the intermediate stations. The service plan envisions at least four limited-stop trains per hour in each direction, all day long, on the main route between San Francisco and Los Angeles. Each intermediate station in the Bay Area, Central Valley between Fresno and Bakersfield, Palmdale in the High Desert, and Sylmar and Burbank in the San Fernando Valley would be served by at least two limited-stop trains every hour—offering at least two reasonably fast trains an hour to San Francisco and Los Angeles. Selected limited-stop trains would be extended south of Los Angeles as appropriate to serve projected demand.

Including the limited-stop trains on the routes between Sacramento and Los Angeles, and Los Angeles and San Diego, and the frequent-stop local trains between San Francisco and Los Angeles/Anaheim, and Sacramento and San Diego, every station on the HSR network would be served by at least two trains per hour per direction throughout the day and at least three trains per hour during the morning and afternoon peak periods. Stations with higher ridership demand would generally be served by more trains than those with lower estimated ridership demand.

The service plan provides direct-train service between most station pairs at least once per hour. Certain routes may not always be served directly, and some passengers would need to transfer from one train to another at an intermediate station, such as Los Angeles Union Station, to reach their destination. Generally, the Phase 1 conceptual operations and service plans offer a wide spectrum of direct-service options and minimize the need for passengers to transfer.

In 2029, the assumed first year of Phase 1 HSR operation, two trains per hour would operate during peak and one train per hour off-peak between San Francisco and Bakersfield. When Phase 1 operations occur, this EIR/EIS assumes the following service:

- Two peak trains per hour from San Francisco and Los Angeles (one in off-peak)
- Two peak trains per hour from San Francisco and Anaheim (one in off-peak)
- Two peak trains per hour from San Jose and Los Angeles
- One peak train per hour from Merced and Los Angeles
- One train per hour (peak and off-peak) from Merced and Anaheim

Total daily operations for the Project Section in 2029 and 2040 are shown in Table 2-19.

**Table 2-19 Total Daily Train Operations—San Francisco to San Jose Project Section**

Service Description	2029	2040
<b>HSR Non-Revenue Trains<sup>1</sup></b>		
Between Brisbane LMF and San Francisco	11	22
Between San Jose Diridon Station and Millbrae Station	0	12
<b>HSR Revenue Trains</b>		
Trains per peak hour (max, one-way)	2	4
Trains per off-peak hour (max, one-way)	1	3
Trains per peak period per day (max)	24	48

Service Description	2029	2040
Trains per off-peak period per day (max)	24	74
Number of daytime operations: 7 a.m.–10 p.m. (max)	40	102
Number of nighttime operations: 10 p.m.–7 a.m. (max)	8	20
<b>Total HSR Trains, San Francisco and Brisbane LMF</b>		
Trains per peak period per day (max)	28	56
Trains per off-peak period per day (max)	31	88
Number of daytime operations: 7 a.m.–10 p.m. (max)	44	110
Number of nighttime operations: 10 p.m.–7 a.m. (max)	15	34
<b>Total HSR Trains, San Francisco and San Jose Diridon Station</b>		
Trains per peak period per day (max)	24	80
Trains per off-peak period per day (max)	24	96
Number of daytime operations: 7 a.m.–10 p.m. (max)	40	148
Number of nighttime operations: 10 p.m.–7 a.m. (max)	8	28

HSR = high-speed rail

LMF = light maintenance facility

<sup>1</sup> Non-revenue train trips include the operation of trains entering or leaving service at a terminal station to and from a maintenance facility, test runs, and operation of on-track maintenance equipment.

## 2.8.2 Maintenance Activities

### 2.8.2.1 *Blended Portions of the Project Section*

The Authority would be a tenant operating within the Caltrain right-of-way for the blended portions of the Project Section. The PCJPB would continue to perform regular maintenance along the track and railroad right-of-way as well as on the power systems, train control, signaling, communications, and other vital systems required for the safe operation of the blended system. Maintenance methods would be like those currently used for the existing Caltrain system and would involve:

- Inspection and routine maintenance of the track and ballast, including tamping; OCS; structures; and signaling, train control, and communications components
- Inspections and daily maintenance of the stations and the LMF
- Maintenance of the right-of-way including culvert and drain cleaning, vegetation control, litter removal, and other inspection that would typically occur monthly to several times a year

### 2.8.2.2 *Dedicated Portions of the Project Section*

The Authority would regularly perform maintenance along the dedicated track and railroad right-of-way as well as on the power systems, train control, signaling, communications, and other vital systems required for the safe operation of the HSR system. Maintenance methods are expected to be similar to existing European and Asian HSR systems, adapted to the specifics of the California HSR. However, the FRA would specify standards of maintenance, inspection, and other items in a set of regulations (i.e., Rule of Particular Applicability) to be issued in the next several years, and the overseas practices may be amended in ways not currently foreseen. The brief descriptions of maintenance activities provided in the following subsections are thus based on best professional judgment about future practices in California.

## Track and Right-of-Way

The track at any point would be inspected several times each week using measurement and recording equipment aboard special measuring trains. These trains are of similar design to the regular trains but would operate at a lower speed. They would run between midnight and 5 a.m. and would usually pass over any given section of track once in the night.

Most adjustments to the track and routine maintenance would be accomplished in a single night at any specific location with crews and material brought by work trains along the line. When rail resurfacing (i.e., rail grinding) is needed, several times a year, specialized equipment would pass over the track sections at 5 to 10 mph.

Approximately every 4 to 5 years, ballasted track would require tamping. This more intensive maintenance of the track uses a train with a succession of specialized cars to raise, straighten, and tamp the track, using vibrating “arms” to move and position the ballast under the ties. The train would typically cover a 1-mile-long section of track in the course of one night’s maintenance. Slab track, the track support type anticipated at elevated sections, would not require this activity. No major track components are expected to require replacement through 2040.

Other maintenance of the right-of-way, aerial structures, culverts, drains, and bridge sections of the alignment would include culvert and drain cleaning, vegetation control, litter removal, and other inspection that would typically occur monthly to several times a year.

## Power

The OCS along the right-of-way would be inspected nightly, with repairs being made when needed; these would typically be accomplished during a single night maintenance period. Other inspections would be made monthly. Many of the functions and status of substations and smaller facilities outside the trackway would be remotely monitored. However, visits would be made to repair or replace minor items and would also be scheduled several times a month to check the general site. No major component replacement for the OCS or the substations is expected through 2040.

## Structures

Visual inspections of the structures along the right-of-way and testing of fire/life safety systems and equipment in or on structures would occur monthly, while inspections of all structures for structural integrity would be conducted at least annually. Steel structures would require painting every several years. Repair and replacement of lighting and communication components of tunnels and buildings would be performed on a routine basis. No major component replacement or reconstruction of any structures is expected through 2040.

## Signaling, Train Control, and Communications

Inspection and maintenance of signaling and train control components would be guided by FRA regulations and standards to be adopted by the Authority. Typically, physical in-field inspection and testing of the system would be conducted four times a year using hand-operated tools and equipment. Communication components would be routinely inspected and maintained, usually at night, although daytime work may be undertaken if the work area is clear of the trackway. No major component replacement of these systems is expected through 2040.

## Stations

Each station would be inspected and cleaned daily. Inspections of the structures, including the platforms, would be conducted annually. Inspections of other major systems, such as escalators, the heating and ventilation system, ticket-vending machines, and closed-circuit television, would be performed according to manufacturer recommendations. Major station components are not expected to require replacement through 2040.

## Perimeter Fencing and Intrusion Protection

Fencing and intrusion protection systems would be remotely monitored, as well as periodically inspected. Maintenance would take place as needed; however, fencing and intrusion protection systems are not expected to require replacement before 2040.

## 2.9 Additional High-Speed Rail Development Considerations

### 2.9.1 High-Speed Rail, Land Use Patterns, and Development around High-Speed Rail Stations

In 2008, California voters approved Prop 1A—which called for HSR stations to “be located in areas with good access to local mass transit or other modes of transportation and further required that the HSR system be planned and constructed in a manner that minimizes urban sprawl and impacts on the natural environment.” The Authority embraced these policies in Prop 1A by adopting the *HST Station Area Development: General Principles and Guidelines* (Authority 2011a) and the *Urban Design Guidelines for the California High Speed Train Project* (Authority 2011c). The purpose of the *HST Station Area Development: General Principles and Guidelines* is to identify principles and the Authority’s approach to support local agency actions to maximize the potential for TOD and value capture in station areas to advance the coordination of land use and transportation planning at state, regional, and local levels to address climate change and reduce GHG production. The purpose of the *Urban Design Guidelines for the California High Speed Train Project* is to draw upon international examples and provide guidance to the Authority and local agencies on how to integrate HSR stations into communities to attract ridership and investment, and advance TOD of lasting economic and community value.

Realizing the potential transportation, community, environmental, and economic benefits of HSR stations to surrounding land uses, the Authority has a strategy for long-term coordination with local jurisdictions and transit agencies to encourage TOD and higher-density urban cores around the HSR stations and to further develop transit connectivity plans for HSR station areas. Within the Project Section, these efforts are ongoing with the City of Millbrae and the City of San Jose.<sup>25</sup> The City of Millbrae approved the Millbrae Station Area Specific Plan in February 2016, which plans for TOD around the Millbrae Station (City of Millbrae 2016). The Authority is currently funding a Comprehensive Station Access Study for the Millbrae Station which is evaluating strategies to enhance station access and connectivity to support long-term growth in transit and HSR ridership, as well as to support agency coordination between the City of Millbrae, Caltrain, BART, and the Authority. The City of San Jose has also received station area planning grants to meet the purposes outlined in the 2011 guidelines, and adopted the *Diridon Station Area Plan* in June 2014 (City of San Jose 2014).

### 2.9.2 Right-of-Way Acquisition for Construction, Operation, and Maintenance of High-Speed Rail

The Project Section would be primarily within the existing Caltrain right-of-way. However, in certain locations along the Caltrain corridor (e.g., at the Brisbane LMF, passing tracks, communication radio towers, and viaducts south of Scott Boulevard), the Authority would need to acquire temporary construction easements (TCE) and permanent right-of-way outside the existing

---

<sup>25</sup> The Authority is also coordinating with local jurisdictions and transit agencies with regard to the SFTC at First and Mission Streets in downtown San Francisco. The Authority is a member of the Transbay Joint Powers Authority, which is a joint exercise of powers authority created by the City and County of San Francisco, the Alameda–Contra Costa Transit District, the PCJPB, the Authority, and Caltrans. The Transbay Joint Powers Authority’s mission is to design, build, operate, and maintain an intermodal terminal and rail extension and to collaborate with the San Francisco Redevelopment Agency and City departments to create an adjacent new transit-oriented neighborhood surrounding the new SFTC. Environmental impacts associated with the DTX have undergone a separate environmental review and clearance process. Refer to the *Transbay Terminal/Caltrain Downtown Extension/Redevelopment Project Final EIS/EIR* for additional information (USDOT et al. 2004).

Caltrain right-of-way to build and operate components of the blended system. Table 2-20 shows the total TCEs and permanent right-of-way acquisitions required for the project.

Permanent right-of-way acquisition would result in the displacement of residences and businesses adjacent to the Caltrain right-of-way in certain locations. The Authority would comply with the Uniform Relocation Assistance and Real Property Acquisition Policies Act, which provides benefits to displaced individuals to assist them financially and with advisory services related to relocating their residence or business operation. The purpose of the Uniform Act is to provide for uniform and equitable treatment of persons displaced from their homes, businesses, farms, or nonprofit organizations by federal and federally assisted programs and to establish uniform and equitable land acquisition policies for federal and federally assisted programs.

**Table 2-20 Right-of-Way Acquisitions (acres)**

Acquisition Type	Alternative A	Alternative B (Viaduct to I-880)	Alternative B (Viaduct to Scott Boulevard)
<b>Temporary Construction Easements</b>			
Residential use	2.5	3.3	4.8
Mixed use	2.7	6.6	6.8
Commercial use	13.5	17.7	16.8
Industrial use	34.4	18.8	31.9
Planned development	0.2	0.1	0.1
Public facilities	3.2	11.4	10.5
Parks/open space	<0.1	4.3	5.2
Transportation use	4.0	23.6	27.7
Vacant	51.9	13.7	13.7
<b>Total</b>	<b>112.6</b>	<b>99.8</b>	<b>117.8</b>
<b>Permanent Right-of-Way Acquisition</b>			
Residential use	14.5	10.7	9.8
Mixed use	1.5	2.8	2.8
Commercial use	7.6	15.7	15.9
Industrial use	82.1	101.0	92.7
Public facilities	5.8	6.5	7.1
Parks/open space	6.1	4.0	4.0
Transportation use	34.9	36.9	40.5
Vacant	86.3	99.1	99.1
<b>Total</b>	<b>238.8</b>	<b>276.7</b>	<b>271.9</b>

I- = Interstate

### 2.9.3 High-Speed Rail Development within the San Francisco Bay Conservation and Development Commission Jurisdictional Areas

BCDC regulates activities and development within and around San Francisco Bay as defined by the McAteer-Petris Act, consistent with the policies adopted in the San Francisco Bay Plan (the Bay Plan). The McAteer-Petris Act affords BCDC jurisdiction over five areas in and around the Bay: (1) “Bay” jurisdiction (all areas subject to tidal action), (2) “shoreline” jurisdiction (a 100-foot-wide band along the Bay shoreline, salt ponds diked off from the Bay, managed wetlands that have been diked off from the bay, and certain waterways), (3) “saltponds” jurisdiction, (4) “managed wetlands” jurisdiction, and (5) “certain waterways” jurisdiction (defined in BCDC’s Bay Plan). Only two of these BCDC jurisdictional areas are relevant for the project: the Bay and shoreline jurisdictions.

The agency’s decision to grant or deny a permit for the project is guided by the Act’s provisions and the standards set out in the Bay Plan. The BCDC is authorized to regulate fill or dredge the San Francisco Bay and development of the “shoreline band,” which consists of the area within 100 feet of the shoreline.

The project includes areas within BCDC jurisdiction at Mission Creek and Islais Creek in San Francisco; Visitacion Creek, Guadalupe Valley Creek, and Brisbane Lagoon in Brisbane; Oyster Point Channel and Colma Creek in South San Francisco; and El Zanjon Creek in San Bruno. Figure 2-48 through Figure 2-50 illustrate the project footprints overlain with the BCDC jurisdiction, including priority use areas, and Table 2-21 describes the specific project improvements within BCDC jurisdiction. Although the project alternatives do not include new features that provide for public access to the Bay, access to existing parks and recreational facilities along the Bay—including the San Francisco Bay Trail, Mission Creek Park, Candlestick Point State Recreation Area, Brisbane Lagoon, and Bayfront Park—would be maintained.



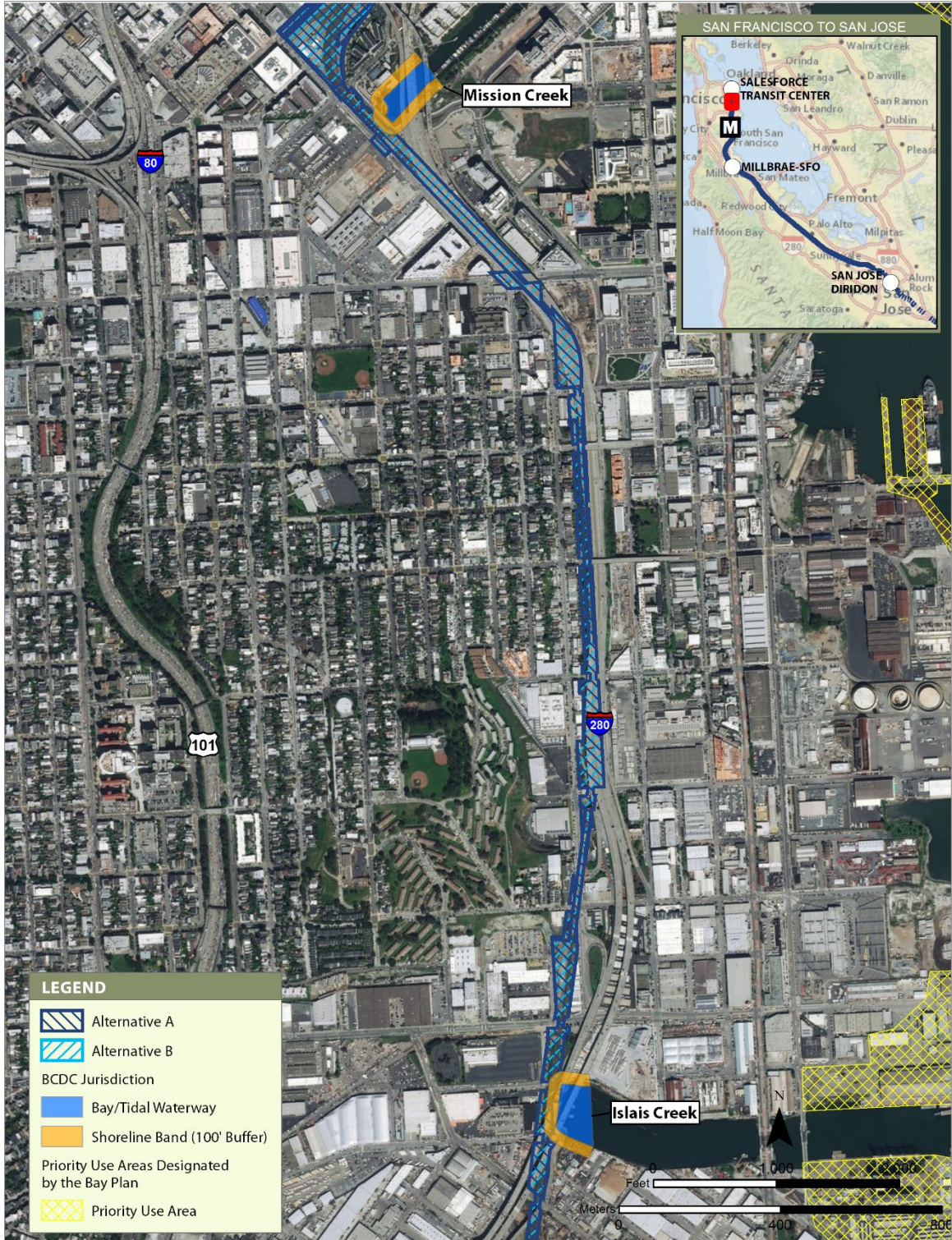

OCTOBER 2019

Figure 2-48 BCDC Jurisdictional and Priority Use Areas—Part 1 of 3



OCTOBER 2019

Figure 2-49 BCDC Jurisdictional and Priority Use Areas—Part 2 of 3



OCTOBER 2019

Figure 2-50 BCDC Jurisdictional and Priority Use Areas—Part 3 of 3

**Table 2-21 Project Elements within BCDC Jurisdictional Areas**

Location	Alternative A	Alternative B
<b>Mission Creek</b>		
Bay/Tidal Waterway	None	None
Shoreline Band	Although a portion of the permanent blended HSR/Caltrain right-of-way overlaps with the shoreline band, no project improvements are proposed within the shoreline band.	Same as Alternative A
<b>Islais Creek</b>		
Bay/Tidal Waterway	Although a portion of the permanent blended HSR/Caltrain right-of-way overlaps with the bay/tidal waterway, no project improvements are proposed within the bay/tidal waterway.	Same as Alternative A
Shoreline Band	Although a portion of the permanent blended HSR/Caltrain right-of-way overlaps with the shoreline band, no project improvements are proposed within the shoreline band.	Same as Alternative A
<b>Visitacion Creek</b>		
Bay/Tidal Waterway	Construction of the East Brisbane LMF would require placing the creek into an underground culvert. A new maintenance facility yard, workshop, parking lot and access road, and realigned Tunnel Avenue would be built above the underground culvert.	None
Shoreline Band	Construction of the East Brisbane LMF would require construction of a new maintenance facility yard, workshop, parking lot and access road, and realignment of Tunnel Avenue within the shoreline band.	None
<b>Guadalupe Valley Creek</b>		
Bay/Tidal Waterway	The existing culvert where Guadalupe Valley Creek crosses the railbed would be extended, and the Guadalupe Valley Creek bridge would be widened.	Same as Alternative A
Shoreline Band	Permanent roadway right-of-way and a TCE would be required within the shoreline band to accommodate demolition of the existing Tunnel Avenue overpass, construction of a new realigned Tunnel Avenue overpass, and relocation of the southern terminus of Tunnel Avenue to the Bayshore Boulevard/Valley Drive intersection. Additionally, portions of the permanent blended HSR/Caltrain right-of-way overlap with the shoreline band; in these locations the project would horizontally shift existing tracks to accommodate the new lead tracks to the LMF, relocate OCS poles and wires, and would widen the Guadalupe Valley Creek bridge.	Same as Alternative A
<b>Brisbane Lagoon</b>		
Bay/Tidal Waterway	Although a portion of the existing Caltrain right-of-way overlaps with the bay/tidal waterway, no project improvements are proposed within the bay/tidal waterway.	Same as Alternative A

Location	Alternative A	Alternative B
Shoreline Band	Permanent roadway right-of-way and TCEs would be required within the shoreline band in an area designated as a priority use area, to realign Lagoon Road and its connection to the realigned Tunnel Avenue and Tunnel Avenue overpass. The existing Tunnel Avenue overcrossing of the Caltrain tracks, which is also within the shoreline band in an area designated as a priority use area, would be demolished.	Same as Alternative A
<b>Oyster Point Channel</b>		
Bay/Tidal Waterway	Although a portion of the permanent blended HSR/Caltrain right-of-way overlaps with the bay/tidal waterway, no project improvements are proposed within the bay/tidal waterway.	Same as Alternative A
Shoreline Band	Although a portion of the permanent blended HSR/Caltrain right-of-way overlaps with the shoreline band, no project improvements are proposed within the shoreline band.	Same as Alternative A
<b>Colma Creek</b>		
Bay/Tidal Waterway	Although a portion of the permanent blended HSR/Caltrain right-of-way overlaps with the bay/tidal waterway, no project improvements are proposed within the bay/tidal waterway.	Same as Alternative A
Shoreline Band	Although a portion of the permanent blended HSR/Caltrain right-of-way overlaps with the shoreline band, no project improvements are proposed within the shoreline band.	Same as Alternative A
<b>El Zanjon Creek</b>		
Bay/Tidal Waterway	Although a portion of the permanent blended HSR/Caltrain right-of-way overlaps with the bay/tidal waterway, no project improvements are proposed within the bay/tidal waterway.	Same as Alternative A
Shoreline Band	Although a portion of the permanent blended HSR/Caltrain right-of-way overlaps with the shoreline band, no project improvements are proposed within the shoreline band.	Same as Alternative A

HSR = high-speed rail  
 LMF = light maintenance facility  
 OCS = overhead contact system  
 TCE = temporary construction easement

## 2.10 Construction Plan

This section describes the Authority's phased implementation strategy for building the HSR system and summarizes the general approach to activities typically associated with pre-construction and construction of major system components. Additional detail is provided in Volume 2, Appendix 2-H. The construction plan is based on the phased implementation strategy for Phase 1 of the HSR system as described in the Authority's 2018 Business Plan,<sup>26</sup> which assumes that:

- HSR Valley-to-Valley service would be operational in 2029.
- Phase 1, which would connect San Francisco with Los Angeles via the Central Valley, would be operational by 2033.
- The analysis in this document is based on impact assessment in 2029 (initial operation) and 2040 (operations after initial ridership build-up).
- Phase 2, which would subsequently extend service to Sacramento and San Diego for full system operation, would occur after the 2040 Phase 1 system operations envisioned in the Draft EIR/EIS.

Table 2-22 and Table 2-23 shows the generalized approach to project construction phasing and schedule for portions of the Project Section north and south of Scott Boulevard. Construction would likely proceed concurrently along the entire Project Section. Construction would typically take place 5 days a week with 8-hour days (250 days per year), except for track realignment within the Caltrain corridor, which would need to occur within established work windows, which include weekdays (outside of AM and PM peak hours), weeknights, and weekends.

The assumed Phase 1 opening year for purposes of the construction plan differs by 4 years from the Phase 1 opening year discussed in Section 2.7, Ridership. As explained in Section 2.7.1, Travel Demand and Ridership Forecasts, the HSR ridership forecasts used in this document are derived from the 2016 Business Plan which assumed a 2025 opening year for Phase 1, but since the 2018 Business Plan identified that the Valley-to-Valley scenario would commence operation in 2029, the 2025 ridership from the 2016 Business Plan is presumed to occur in 2029. If the actual opening year is later (e.g., 2033), there would be an incremental reduction in operational impacts and benefits in 2040 as described in Chapter 3, but not a material change. The 2033 Phase 1 opening year, on the other hand, represents the more appropriate assumption for purposes of the construction plan and evaluating construction-related impacts. The document therefore uses both opening year assumptions.

### 2.10.1 General Approach

The Authority would begin implementing its construction plan after receiving the required environmental approvals and permits and securing funding. Given the size and complexity of the HSR project, the design and construction work could be divided into several procurement packages. In general, the procurement would be grouped as follows:

- Civil/structural infrastructure, including design and construction of passenger stations, maintenance facilities, wayside facilities, utility relocations, and roadway modifications
- Trackwork, including design and construction of direct fixation track and subballast, ballast, ties and rail installation, switches, and special trackwork
- Core systems, such as traction power, train controls, communications, the operations center, and the procurement of trainsets

---

<sup>26</sup> The Authority's Draft 2020 Business Plan assumes a similar phased implementation strategy for Phase 1 of the HSR system, although the Valley-to-Valley service operational date was refined from 2029 to 2031 (Authority 2020a).

One or more design-build packages would be developed. The Authority would issue construction requests for proposals, begin right-of-way acquisition, and procure construction management services to oversee physical construction of the project. During peak construction periods, work would be performed concurrently in different subsections, with overlapping construction of various project elements. Working hours and the number of workers present at any time would depend on the activities being performed. Construction fencing would be restricted to areas designated for construction staging and areas where public safety or environmentally sensitive resources are a concern.

**Table 2-22 Construction Schedule North of Scott Boulevard**

Activity	2018	2019	2020	2021	2022	2023	2024	2025	2026	2027	2028	2029
<b>At Grade, Viaduct, and Trench</b>												
Right-of-way acquisition		■	■									
Environmental remediation		■	■									
Design			■	■								
Mobilization				■								
Utilities relocation				■	■							
Street/highway preparation				■	■	■	■					
Demolition				■	■	■						
Clear and grub				■	■	■	■					
Earthwork				■	■	■	■					
Viaduct				■	■	■	■					
At-grade work					■	■	■	■				
Demobilize								■				
<b>Stations and Maintenance Facilities</b>												
Right-of-way acquisition			■	■								
Design			■	■								
Mobilization				■								
Temporary facilities and track				■								
Building demolition				■								
Building structures and rough systems					■							
Building finish						■	■					
Remove/restore temporary facilities and track							■	■				
Demobilize								■				
<b>Rail Infrastructure and Testing</b>												
Mobilization							■					
Track, signal, and traction power construction								■	■			
Static testing									■			
Dynamic testing										■		
Full speed testing											■	
Demobilize												■
<b>Assumed Milestones per High-Speed Rail</b>												
Service San Francisco to San Jose (start of 2029)												



**Table 2-23 Construction Schedule, Scott Boulevard to West Alma Avenue**

Activity	2021	2022	2023	2024	2025	2026	2027	2028	2029
<b>At Grade, Viaduct, and Trench</b>									
Right-of-way acquisition	█	█	█						
Environmental remediation		█	█						
Design	█	█							
Mobilization		█							
Utilities relocation			█						
Street/highway preparation			█	█	█				
Demolition			█						
Clear and grub			█						
Earthwork			█	█	█				
Viaduct			█	█	█				
At-grade and below-grade cross sections (incl. stations)			█	█	█				
Demobilize					█				
<b>Rail Infrastructure and Testing</b>									
Mobilization				█					
Track, signal, and traction power construction				█	█				
Static testing					█				
Dynamic testing					█				
Full speed testing					█				
Demobilize					█				
<b>Stations and Maintenance Facilities</b>									
Right-of-way acquisition	█	█	█						
Design			█						
Mobilization			█	█					
Temporary facilities and track				█					
Building demolition				█					
Building structures and rough systems				█	█				
Building finish				█	█				
Remove/restore temporary facilities and track				█	█				
Demobilize					█				
<b>Assumed Milestones per High-Speed Rail</b>									
Service Central Valley to San Jose (end of 2029)									█

Consistent with the California High-Speed Rail Authority Sustainability Policy (Authority 2016f), the Authority would continue to implement sustainability practices that inform and affect the planning, siting, designing, construction, mitigation, operation, and maintenance of the HSR system. The Authority is committed to:

- Net-zero GHG and criteria pollutant emissions in construction
- Operating the system entirely on renewable energy
- Net-zero energy, LEED platinum facilities
- Planning for climate change adaptation and resilience
- Prioritizing life-cycle considerations
- Applicable design standards, including compliance with laws, regulations, and industry standard practices (included in Volume 2, Appendix 2-D and considered a part of the project)

## **2.10.2 Pre-Construction Activities**

### **2.10.2.1 Operational Right-of-Way**

During final design, the Authority and its contractors would conduct several pre-construction activities to optimize construction staging and management. These activities include the following:

- Conducting geotechnical investigations to define precise geologic, groundwater, and seismic conditions along the alignment. The results of this work would guide final design and construction methods for foundations, stations, and aerial structures.
- Identifying construction laydown and staging areas used for mobilizing personnel, stockpiling materials, and storing equipment for building HSR or related improvements. In some cases, these areas would also be used to assemble or prefabricate components of guideway or wayside facilities before transport to installation locations. Field offices and temporary jobsite trailers would also be located at the staging areas. Construction laydown areas are part of the project footprint that is evaluated for potential environmental impacts; however, actual use of the area would be at the discretion of design-build contractor. After completing construction, the staging and laydown areas would be restored to pre-construction condition.
- Initiating site preparation and demolition, such as clearing, grubbing, and grading, followed by the mobilization of equipment and materials. Demolition would require strict controls so that adjacent buildings, infrastructure, and natural and community resources are not damaged or otherwise affected by the demolition efforts.
- Relocating utilities prior to construction. The contractor would work with the utility companies to relocate or protect in place high-risk utilities, such as overhead tension wires, pressurized transmission mains, oil lines, fiber optical conduits or cables, and communications lines or facilities prior to construction.
- Implementing temporary, long-term, and permanent road closures to reroute or detour traffic away from construction activities. Handrails, fences, and walkways would be provided for the safety of pedestrians and bicyclists.
- Conducting other studies and investigations, as needed, such as surveys of local business to identify usage, delivery, shipping patterns, and critical times of the day or year for business activities, as well as necessary cultural resource investigations, and historic property surveys. This information would help develop construction requirements and worksite traffic control plans and identify potential alternative routes and resource avoidance plans.

Temporary staging for Alternatives A and B would occur primarily within the existing Caltrain right-of-way, with exception of temporary staging areas outside of the existing Caltrain right-of-way for construction of the Brisbane LMF, Millbrae Station, passing track (Alternative B only), and in the San Jose Diridon Station Approach Subsection. Track modifications would mostly be performed by track-mounted equipment, and construction materials (e.g., rail, ties, ballast) would be delivered by

rail. Modifications to existing Caltrain station platforms would be isolated to each Caltrain station and associated parking lots, which are within the existing Caltrain right-of-way. At-grade crossing improvements would not require separate construction staging areas.

There are four locations where construction staging areas greater than 5 acres outside the existing Caltrain right-of-way would be required:

- Brisbane LMF—Construction of both the East Brisbane LMF under Alternative A and the West Brisbane LMF under Alternative B would require TCEs (approximately 74 acres and 19 acres, respectively) to establish equipment and materials storage areas close to construction sites for the LMF and the realigned Tunnel Avenue overpass.
- Millbrae Station—Construction of both project alternatives would require approximately 8 acres of TCE east and west of the Millbrae Station to establish equipment and materials storage areas close to construction sites, build a new HSR station concourse and platforms, build overhead circulation elements between the new station and platforms, and modify roadways.
- Passing track (Alternative B only)—Construction of the approximately 6-mile-long passing track under Alternative B would require the use of nearly 10 acres of land within the passing track footprint. This would typically consist of a 15-foot-wide strip of land on both sides of the Caltrain corridor, although a larger area of TCE would be required near the Hillsdale Boulevard underpass, where the existing structure would need to be modified and a new structure to carry the additional tracks over Hillsdale Boulevard would be built.
- San Jose Diridon Station Approach Subsection—There are two potential construction staging areas included within the preliminary engineering design in this subsection. Alternative A includes a potential 8.4-acre staging area east of Lafayette Street. Alternative B includes a potential 9-acre staging area north of West Julian Street between Caltrain/UPRR and New Montgomery Street.

Land needed for temporary construction activities would be leased from landowners, taken out of its current use, used temporarily for construction, and restored to its pre-construction state after construction is completed. As shown in Table 2-22, construction of Alternative A would require the temporary use of 112.6 acres of land outside the Caltrain right-of-way, Alternative B (Viaduct to I-880) would require the temporary use of 99.8 acres, and Alternative B (Viaduct to Scott Boulevard) would require the temporary use of 117.8 acres outside the Caltrain right-of-way. TCEs would typically be on roadway rights-of-way, shoulders of the existing railroad tracks, backyards, or vacant areas adjacent to structures that are used for residential, commercial, mixed-use, industrial, public facilities, and parks/open-space purposes. These TCEs would be used for construction equipment and materials staging; no precasting yards or batch plants for concrete manufacturing would be required for project construction.

### **2.10.2.2 Non-Operational Right-of-Way**

In certain negotiated right-of-way purchase situations, the Authority may enter into agreements to acquire properties or portions of properties that are not directly needed for the construction of the HSR project and are not intended to be part of the operational right-of-way. These are known as excess properties, and are distinct from severed remnant parcels (which are evaluated as part of the project footprint). While eventually these properties would likely be sold as excess state property, these excess properties are not part of the project footprint and in the interim the Authority would need to conduct various management and maintenance activities on them (Authority 2018b).

The process for acquisition and disposal of excess property is detailed in Chapter 16 of the California High-Speed Rail Authority Right-of-Way Manual (January 2019). Chapter 11 of the manual identifies the following management and maintenance activities that may occur on any given excess property. The activities required on a given parcel would depend on site conditions including the presence of buildings or other structures, existing land uses, and habitat conditions.

## Structure Demolition

Various structures may be present on excess property, including single-family and multifamily residences, mobile homes, mobile offices, warehouses and other light industrial structures, sheds, fences, concrete driveways, signs, other buildings, and related appurtenances and utilities (e.g., in-ground pools, septic systems, water wells, gas lines) as well as orchards and ornamental shrubs and trees.

If the Authority determines that any existing uses of a particular structure are not going to continue, it may, following additional environmental review if/as necessary (e.g., to confirm the structure is not considered historic), decide to demolish and remove the structure. Demolition of a structure may also be appropriate if the structure is in a state of disrepair or a potential safety and security concern exists from trespassers.

The properties may include utilities such as water wells, septic systems, gas, and electric lines that would require removal in accordance with local and state regulations. Local construction permits for demolition and removal would be secured from the local agency with jurisdiction (e.g., well demolition permit, septic removal).

## Vegetation Management

Excess properties may have a variety of vegetation present including ornamental landscaping, various crops including orchards or vineyards, and natural habitats such as annual grassland. Vegetation management may occur as part of initial site clearing efforts or as part of ongoing management.

Initial site clearing is likely to occur in conjunction with structure demolition. Ornamental landscaping may be removed to reduce ongoing maintenance needs. Vegetation removal or disturbance may be necessary for equipment access during structure demolition. If certain agricultural crops are present on-site, particularly orchards or vineyards, they may be removed if the Authority determines that it is appropriate based on the condition of the plants.

Ongoing vegetation management activities may include mowing, discing, or similar mechanical control, the clearing of firebreaks on larger properties, and, treating noxious weeds with the use of approved herbicides. Mowing or other mechanical control may be used to maintain vegetation at a certain height or density based on site-specific concerns of security, visual appearance, or fire prevention. The mechanical control of weed species may also be appropriate depending on the relevant species and site conditions. Firebreaks may be mowed or disced in an approximately 12-foot band around the exterior of a site. Internal fire breaks may be appropriate for larger sites. All herbicide application would be conducted in a manner consistent with product labeling and applicable laws including application by a licensed pest control advisor, if appropriate.

## Pest Management

Pest management may include the mechanical control of insects, rodents and other animals. Mechanical removal (trapping) of rodents and other animals may be appropriate in or around structures that exist on excess properties. Mechanical removal of animals will be conducted by a licensed pest control advisor and after obtaining any appropriate local approvals. Rodenticide would not be used for the control of animals.

Chemical control of insects may occur in or around buildings on excess property or in agricultural areas to control pest species. Any pesticide application would be conducted in a manner consistent with product labeling and applicable laws including application by a licensed pest control advisor if appropriate and after obtaining any appropriate local approvals.

## Site Security

Site security would primarily consist of the installation of fencing around properties. The installation of fencing may be appropriate on properties where structures would remain or where there is a safety and security concern or particular risk of trespass. Fencing would consist of 6- to 12-foot-high chain-link fencing and may include barbed wire or similar features at the top. Fence posts may be either metal or wood and require an excavation up to 4 inches in diameter and 3

feet deep. Other security devices such as security lighting, an alarm system or cameras may be implemented if specific conditions require it. If buildings or other structures are present on the site, windows and doors may be boarded up to prevent trespass. “No Trespassing” or similar signs may be posted as appropriate. Site security would also involve the periodic inspection of excess properties for signs of trespass and the removal of any accumulated trash or dumping.

**Structure Maintenance**

If buildings or other structures remain on-site, they would be maintained in a clean and orderly condition so as not to detract from the general appearance of the neighborhood. If the property is rented or leased, maintenance activities would be undertaken as needed to protect the health and safety of occupants. Maintenance and repair activities may include exterior and interior painting, yard maintenance, repair or replacement of plumbing, electrical facilities, roofs, windows, heaters, and built-in appliances and other similar activities.

**2.10.3 Major Construction Activities**

Major types of construction activities for the project include demolition, grubbing, and earthwork; trackwork; station modifications; construction of the Brisbane LMF; construction of aerial structures; and roadway modifications. Estimated construction durations for various project features are summarized in Table 2-24 and discussed in greater detail in the following sections.

**Table 2-24 Estimated Construction Durations by Project Component**

Description of Activity	Alternative		Duration <sup>1</sup>
	A	B	
<b>Track Modifications</b>			
Minor track shifts <1 foot	X	X	Several days at a given location (approximately 2,500 feet/night)
Track shifts > 1 foot and overhead contact system pole relocations	X	X	Several weeks at a given location (approximately 600 feet/weekend)
<b>Station Modifications</b>			
4th and King Street Station	X	X	1 year
Millbrae Station	X	X	2 years
San Jose Diridon Station (at grade)	X		2 years
San Jose Diridon Station (aerial) and aerial viaducts		X	3–4 years
Other Caltrain station modifications	X	X	3–6 months
<b>Light Maintenance Facility</b>			
East or West Brisbane light maintenance facility	X	X	2–3 years
<b>Passing Track</b>			
Passing track		X	4.5 years, although the duration would be less at a given location
<b>Safety and Security Modifications</b>			
Installation of four-quadrant gates	X	X	2–4 weeks
Caltrain station improvements to remove hold-out rule	X	X	9–12 months
<b>Other Modifications</b>			
Installation of communication radio towers	X	X	3–6 months

Description of Activity	Alternative		Duration <sup>1</sup>
	A	B	
Utility relocations	X	X	1–2 weeks
Major roadway modifications	X	X	6 months to 2 years, depending on roadway and proposed modification

### 2.10.3.1 Demolition, Grubbing, and Earthwork

The first stage of construction would involve the demolition of building and roadway structures directly affected by the HSR system. Several activities would need to be conducted before demolition work can commence, including:

- Relocation of building occupants and roadways
- Completion of a demolition survey and demolition plan
- Removal and disposal of hazardous materials in a safe and controlled manner, if any hazardous materials such as asbestos are identified
- Obtaining permits from the Bay Area Air Quality Management District

After mobilizing and setting up the construction staging areas, the contractor would commence with clearing and grubbing areas of new right-of-way in advance of the major structures, roadway and utility relocations. This activity (clearing and grubbing) consists of the removal of top soil, trees, minor physical objects, and other vegetation from the construction site with use of specialized equipment for raking, cutting, and grubbing.

Construction would also involve earthwork, which includes both excavation and embankment. Excavation is the removal of soils by use of mechanical equipment and embankment is the placing and compacting of soils for the construction process with use of mechanical equipment. The HSR system seeks to balance the volume of soils needed for excavation and embankment and to minimize the input of materials from quarries and disposal of materials outside of the right-of-way.

Overall, earthwork activities for the Project Section would be minor because construction would occur mostly on the existing at-grade Caltrain alignment. The exceptions are earthwork required for construction of the Brisbane LMF, realignment of the Tunnel Avenue overpass, the construction of the passing tracks under Alternative B and alignment work in the San Jose Diridon Station Approach Subsection under Alternative A. Estimated earthwork volumes by alternative and project feature are summarized in Table 2-25. Construction of both project alternatives would require the disposal of excavated materials. Construction of Alternative B would reuse 100 percent of excavated materials suitable for embankment construction, while Alternative A would reuse 26 percent of excavated materials suitable for embankment construction.

**Table 2-25 Estimated Earthwork Volumes by Alternative (cubic yards)**

Earthwork Type	Alternative A				Alternative B <sup>1</sup>			
	East Brisbane LMF	Tunnel Avenue Overpass	San Jose Diridon Station Approach	Total	West Brisbane LMF	Tunnel Avenue Overpass	Passing Tracks	Total
Excavation of topsoil and overbreak <sup>2</sup>	274,200	0	48,300	322,500	638,200	0	161,700	799,900
Excavation of cut material <sup>3</sup>	2,183,800	350,000	72,900	2,606,700	1,893,000	350,000	177,100	2,420,100

Earthwork Type	Alternative A				Alternative B <sup>1</sup>			
	East Brisbane LMF	Tunnel Avenue Overpass	San Jose Diridon Station Approach	Total	West Brisbane LMF	Tunnel Avenue Overpass	Passing Tracks	Total
Embankment materials required	89,300	190,100	42,300	321,700	1,063,000	190,100	619,300	1,872,400
Overbreak fill required	285,800	0	58,900	344,700	4,500	0	248,800	253,300
Subballast materials required	0	0	23,200	23,200	0	0	855,400	855,400
<b>Total materials to be disposed</b>	<b>2,082,800</b>	<b>160,000</b>	<b>20,000</b>	<b>2,262,800</b>	<b>1,463,700</b>	<b>160,000</b>	<b>0</b>	<b>1,623,700</b>
<b>% reuse of suitable excavated materials</b>	<b>17%</b>	<b>54%</b>	<b>100%</b>	<b>26%</b>	<b>79%</b>	<b>54%</b>	<b>100%</b>	<b>100%</b>

Sources: Authority 2019a, 2019b

LMF = light maintenance facility

<sup>1</sup> No earthwork required for viaduct construction in the San Jose Diridon Station Approach Subsection

<sup>2</sup> Topsoil and overbreak are materials not suitable for embankment construction.

<sup>3</sup> Cut materials are suitable for embankment construction.

### 2.10.3.2 Track Modifications and Overhead Contact System Adjustments

Within the blended Caltrain corridor, trackwork would follow Caltrain practices and standards for conventional ballast track for at-grade alignments. Since the Caltrain tracks would be upgraded to meet FRA Class 6 Track standards, the construction methods would follow 49 C.F.R. Part 213 Subpart G requirements. Construction would include the following:

- Lateral alignment adjustments—The primary track modifications in the Project Section would be for curve straightening to allow for increased operational speeds on the corridor. Track realignments of less than 1 foot would be performed by track-mounted equipment that would operate along the existing Caltrain tracks as it adjusts track alignment and ballast (Figure 2-51); these track realignments would not require relocation of OCS poles and would be completed within several days at any given location. Track realignments of less than 10 feet (Figure 2-52) would be done at night or on weekends over several work windows to allow continued passenger service; relocation of OCS poles would be required, and speed restrictions would be imposed until the track realignment is completed. For realignments of more than 10 feet, a parallel track and new OCS poles would be built first and then connected to the existing track. Temporary track closure for reconnecting tracks would occur at night or on weekends and would take 1 to 2 days each. The track realignment works would be carried out according to track possession work windows and work segments as follows:
  - Work windows
    - Weekday days, each day (Monday through Friday): Midday during the week between morning and afternoon rush hours. Single tracking between 9 a.m. and 5 p.m.
    - Weekday nights (Monday and Thursday only): Single tracking between 8 p.m. and 4 a.m., Monday night and Thursday nights, with both tracks out of service after completion of revenue operations, between 1 a.m. and 4 a.m.
    - Weekends (Friday night to Monday morning): Weekend, single-tracking, 56-hour continuous work window from 8 p.m. Friday night to 4 a.m. Monday morning, with both tracks out of service after completion of revenue operations between 1 a.m. and 4 a.m. Friday, Saturday, and Sunday nights

- Work segments
  - Work Segment 1: 7.8 miles (milepost [MP] 0.2 to MP 8.0)
  - Work Segment 2: 21.1 miles (MP 8.0 to MP 29.1)
  - Work Segment 3: 15.4 miles (MP 29.1 to MP 44.5)
  - Work Segment 4: 6.6 miles (MP 44.5 to MP 50.4)
- Other work requirements
  - Work may be performed concurrently in only two work segments. Work would not be allowed to occur in two adjacent work segments
  - Station platforms would be closed occasionally
  - Speed restrictions would be limited to the minimum required period
  - Crossover functionality could be temporarily limited during relocation works



Source: Volume 2, Appendix 2-H

**Figure 2-51 Tamping Machine for Minor Lateral Track Shifts (<1 foot)**



Source: Volume 2, Appendix 2-H

**Figure 2-52 Construction of Lateral Track Shifts (<10 feet)**

- Vertical alignment adjustment—The existing track profile would require modification to allow for increased operational speeds on the corridor, including raising or lowering the profile up to and greater than 6 inches. There are several types of vertical adjustments that could occur:
  - Raising or lowering the profile less than 6 inches requires changes to the ballast layer only; OCS poles can remain in place, and only the contact wire would be adjusted.
  - Raising or lowering the profile more than 6 inches requires reconstruction of the railbed (ballast and subballast layers). Reconstruction of the railbed for conventional ballast track



entails the installation of the roadbed, subballast, ballast, ties, and rail with rail fasteners. OCS poles would need to be reconstructed.

- OCS adjustments—The existing OCS system would be modified based on the alignment modifications to allow for increased operational speeds on the corridor. This would include a new OCS system (Figure 2-53), OCS pole relocation due to horizontal or vertical adjustments to the track profile, or adjustments to the OCS contact wire. OCS adjustments require special considerations because the electrified Caltrain service would be in use at the time the blended system is built.



Source: Volume 2, Appendix 2-H

**Figure 2-53 Overhead Contact System Contact Wire Adjustments**

### **2.10.3.3 Station Modifications**

Construction of the project would require relocation and modification of existing Caltrain stations to accommodate HSR trains passing through or stopping at the stations. Construction at these stations would primarily entail modifications to the existing platforms, minor track shifts, modifications to pedestrian crossings, new pedestrian crossings, and relocation of several existing stations. More extensive construction would be required at the Millbrae Station.

#### **4th and King Street Station**

Modifications to the 4th and King Street Station under both project alternatives would occur over a 2-year period and would involve reconstructing two existing Caltrain platforms in the center of the station yard,<sup>27</sup> installing ramps to the platforms to provide pedestrian access, and realigning tracks. Primary construction staging would be within the 4th and King Street Station terminal facilities in the existing Caltrain right-of-way. Construction activities would be completed while the existing station remains operational; no temporary closures of adjacent Caltrain platforms would be required during construction.

#### **Millbrae Station**

Under both project alternatives, the existing Millbrae Station would be expanded to the west to include a new 800-foot-long center HSR platform between the existing Caltrain tracks, an expanded station concourse, and a new HSR station facility. The existing northbound Caltrain track and shared BART platform would remain while the existing southbound Caltrain track would be demolished. Two new station tracks would serve a new HSR center platform. The southbound Caltrain track and platform would be reconstructed west of the new station tracks serving the HSR platform. The Authority would replace displaced parking and add 37 new spaces.

<sup>27</sup> The project includes raising two platforms, extending one platform to 1,400 feet and extending a second platform to 1,000 feet.

Construction would occur over a 2-year period and would require building demolition, grading, construction above existing passenger facilities, and railway facility expansion. Construction activities would be completed while the existing station remains operational, with Caltrain accessing platforms on either side of the work zone.

### San Jose Diridon Station

For Alternative A, the project would primarily involve installing new turnouts and modifying the configuration of San Jose Diridon Station to build two high-level, 1,400-foot platforms for HSR, retain two platforms for commuter and conventional intercity trains, provide passenger services and train operations support in new structures north and south of the existing station building, build new overhead concourses for passenger access to train platforms, and relocate the existing bus station in stages to accommodate progressive growth in HSR services:

- Valley-to-Valley service (assumed for 2029) would require all passenger platform improvements, HSR passenger and operations support in a building south of the existing station house, and an overhead concourse from the south HSR station building with ramps to the two HSR platforms. Access to existing subway ramps would be retained for HSR passenger egress. Access would also require ramps from the south overhead concourse to the Caltrain platforms.
- Phase 1 Service (assumed for 2033) would require development of another HSR building north of the existing station house, relocation of the existing bus station at that location, a second overhead pedestrian concourse from the north HSR station building with ramps to all train platforms, and closure of all platform ramps down to the subway.

For Alternative B, the project would involve modification of the existing San Jose Diridon Station—existing platforms would be rebuilt, and the vertical circulation would be modified and replaced. Modifying the station would take place in six stages, with one of the station tracks and platforms closed for each stage. The first stage would temporarily close the easternmost Caltrain tracks and platforms to build the HSR viaduct piers and rebuild the platforms. When complete, the easternmost tracks and areas would recommence operation. The second stage would temporarily close the next set of track and platform, and so on through five stages. The sixth stage would build the station house. After completing the five stages of HSR viaduct supports and during construction of the HSR concourse and platforms, all Caltrain tracks and platforms would be operational.

### Other Caltrain Station Modifications

Construction of both project alternatives would also affect the following existing Caltrain stations: Bayshore, San Bruno, Broadway, Hayward Park, and Atherton Caltrain Stations. Additionally, Alternative A would affect the College Park Station and Alternative B would affect the Hillsdale, Belmont, San Carlos, and Santa Clara Caltrain Stations. Construction required at these stations would include:

- Bayshore Station (Alternatives A and B)—The existing Bayshore Station is within the extent of the East or West Brisbane LMF and under the yard lead flyover and pergola structure. Construction of the flyover and pergola structure over the existing station would require falsework over the station if a cast-in-place construction method is used or closure of the south end of the existing platforms if precast construction is used (see Section 2.10.3.6, Bridge and Aerial Structures, for a description of these methods). The southbound platform would need to be relocated to the south. With either construction method, it is not anticipated that the station would be entirely closed or that a temporary station would be required but a portion of the platforms may need to be temporarily closed at times during construction.
- San Bruno Station (Alternatives A and B)—Track modifications at the San Bruno Station would require an extension of the existing platforms approximately 145 feet south and relocation of the existing stairs/ramps to the southern side of the northbound platform. Construction activities would be completed while the existing station remains operational.

- **Broadway Station (Alternatives A and B)**—The station would be reconstructed to eliminate the hold-out rule by building a new northbound platform and extending the southbound platform. Construction activities would be completed while the existing station remains operational, with Caltrain accessing the southbound platform during the construction period.
- **Hayward Park Station (Alternatives A and B)**
  - **Alternative A**—Track modifications at the Hayward Park Station would require realignment of the existing platforms. Construction activities would be completed while the existing station remains operational.
  - **Alternative B**—The Hayward Park Station is within the extent of the passing track under Alternative B, which would require the construction of new outboard platforms and a pedestrian underpass at the station. Construction of the passing tracks through the station would require temporary closure of one platform for single-track or double-track operations. The station would remain open throughout the duration of construction.
- **Hillsdale Station (Alternative B)**—The Hillsdale Station is within the extent of the passing track under Alternative B. The existing (center platform) station would remain in service with no closures as a second center platform would be built alongside the existing station.
- **Belmont Station (Alternative B)**—The Belmont Station is within the extent of the passing track under Alternative B. Construction of the passing tracks through the station would require temporary closure of one platform during single-track operations. The station would remain open throughout the duration of construction.
- **San Carlos Station (Alternative B)**—The San Carlos Station is within the extent of the passing track under Alternative B. Construction of the passing track through the station would relocate the station platforms approximately 2,260 feet south of their current location, and a pedestrian underpass would be built. Construction of the passing track through the station would require temporary closure of one platform during single-track operations. The existing station platforms would remain open throughout the duration of construction until the relocated station platforms are operational.
- **Atherton Station (Alternatives A and B)**—The station would be reconstructed to eliminate the hold-out rule by building a new northbound platform. The existing southbound platform would remain. Construction activities would be completed while the existing station remains operational, with Caltrain accessing the southbound platform during the construction period.
- **Santa Clara Station (Alternative B [Viaduct to Scott Boulevard])**—The existing northbound platform at Santa Clara Station would be reconstructed to accommodate supports for the aerial structure.
- **College Park Station (Alternative A)**—Under Alternative A, the existing College Park station would be reconstructed north of Emory Street on the west side of the Caltrain corridor to eliminate the existing hold-out rule at the station.
- **College Park Station (Alternative B [Viaduct to I-880])**—A new pedestrian underpass would be built near the alignment of Emory Street to connect passengers to the platforms from the east and west sides of the tracks.

Construction work at these stations would be coordinated with the affected transit service providers to maintain access to and operation of existing facilities or provide temporary facilities to support continued operation during construction. Construction could entail shifting the position of the platforms or access, changing platform types, providing grade-separated pedestrian access to platforms, maintaining parking capacity, and other methods to maintain operations.

### **2.10.3.4 Brisbane Light Maintenance Facility**

The project would include construction of an LMF in Brisbane. Construction would occur over an approximately 2- to 3-year period and would involve demolition, grubbing, extensive earthwork,

and utilities relocation. Because the site of the Brisbane LMF under either alternative is relatively hilly, both cut and fill would be required to create a level surface for the workshop, yard, tracks, and supporting systems and utilities. Foundations and footings would be required for the maintenance building, the aerial track flyover to enable access to the LMF, the pergola at the Bayshore Station, and the realigned Tunnel Avenue overpass. New ballasted railbed would be built for the realigned tracks and the yard, which would involve the installation of roadbed, subballast, ballast, ties, and rail with rail fasteners. Track would be shifted laterally by nearly 50 feet in certain locations, and new OCS would be built to accommodate the track shifts and the new yard tracks.

### 2.10.3.5 *Passing Track Construction*

Construction of the passing track under Alternative B would occur over a 4.5-year construction period and would involve demolition, removal of existing track, placement of embankment and construction of retaining walls where the right-of-way is too constrained for embankment slopes, and construction of new ballasted railbed including the installation of roadbed, subballast, ballast, ties, and rail with rail fasteners. Track would be shifted laterally and new OCS poles would be built to accommodate the track shifts. Along much of the length of the passing track, the profile would be embankment or retained fill, which presents staging challenges due to the constrained right-of-way, earthmoving operations, and need to maintain Caltrain service and freight operations during construction.

### 2.10.3.6 *Bridge and Aerial Structures*

Aerial structures for this section would be limited to (1) the realigned Tunnel Avenue overpass; (2) either widening existing bridges or building parallel bridges through the four-tracking areas of Millbrae Station; (3) either widening existing bridges or building parallel bridges for the passing tracks under Alternative B; and dedicated viaducts south of Scott Boulevard or south of I-880 under Alternative B.

As is done for existing HSR systems around the world, the majority of the elevated guideways would be designed and built using single box segmental girder construction. Where needed, other structural types and construction methods would be considered. This section provides an overview of the construction methods required for foundations, substructures, and superstructures of bridges, aerial structures, and roadway crossings. Figure 2-54 illustrates the typical components of aerial structures.

---

#### *Construction Terminology*

- **Girder**—A girder is a large iron or steel beam used for building bridges. The term girder is often used interchangeably with “beam.”
  - **Precast concrete**—A technique, wherein concrete is prepared, cast, and cured off-site, usually using molds.
  - **Cast-in-place concrete**—Also known as poured in place, a technique wherein the concrete is transported to site in an unhardened state.
  - **Falsework**—Temporary structures used in construction to support a permanent structure until its construction is sufficiently advanced to support itself.
-

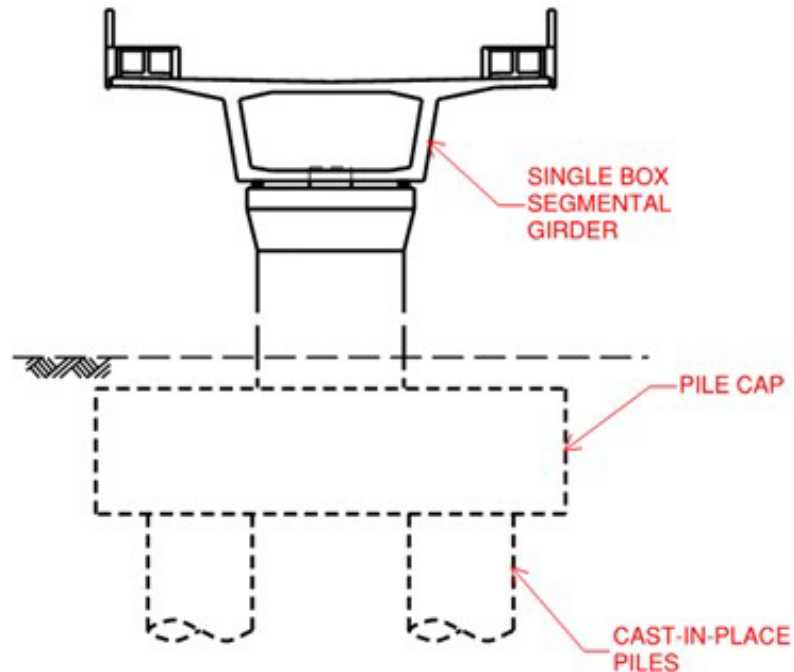

Source: Volume 2, Appendix 2-H

MAY 2017

**Figure 2-54 Typical Aerial Structure Components**

### Foundations

A typical aerial structure foundation pile cap is supported by an average of four large-diameter (5 to 9 feet) bored piles. Depth of piles depends on the geotechnical conditions at each pile site. Pile construction can be achieved by using rotary drilling rigs, and either bentonite slurry or temporary casings may be used to stabilize pile shaft excavation. The estimated pile production rate is 4 days per pile installation. Additional pile installation methods available to the contractor include bored piles, rotary drilling cast-in-place piles, driven piles, and a combination of pile jetting and driving.

Following completion of the piles, pile caps can be built using conventional methods supported by structural steel: either precast and pre-stressed piles or cast-in-drilled hole piles. For pile caps built near existing structures such as railways, bridges, and underground drainage culverts, temporary sheet piling (i.e., temporary walls) can be used to minimize disturbances to adjacent structures. Sheet piling installation and extraction would likely be achieved using hydraulic sheet piling machines.

### Substructure

Typical aerial structures of up to 90 feet would be built using cast-in-place bent caps and columns supported by structural steel and installed upon pile caps. A self-climbing formwork system may be used to build piers and portal beams more than 90 feet high. The self-climbing formwork system is equipped with a winched lifting device, which is raised up along the column by hydraulic means with a structural frame mounted on top of the previous pour. In general, a 3-day cycle for each 12-foot pour height can be achieved. The final size and spacing of the piers depends on the type of superstructure and spans they are supporting.

### Superstructure

The selection of superstructure type would consider the loadings, stresses, and deflections encountered during the various intermediate construction stages, including changes in static scheme, sequence of tendon installation, maturity of concrete at loading, and load effects from

erection equipment. Accordingly, the final design would depend on the contractor's selected means and methods of construction, such as full-span precast, span-by-span, balanced cantilever segmental precast, and cast-in-place construction on falsework. These superstructure construction methods are described in full detail in the *San Jose to Merced Project Section Constructability Assessment Report* (Authority 2019d) and are summarized as follows:

- Full-span precast construction—Box girders would be precast and pre-stressed in advance as a full span and stored in a precasting yard. The 110-foot precast segments, weighing around 900 tons, would be transported along the previously built aerial guideway using a special gantry system (Figure 2-55).
- Span-by-span precast segmental construction—Shorter box girder segments would be precast and pre-stressed, and stored in a precasting yard. These segments, limited to 12-foot segments weighing less than 70 tons, would likely be individually transported to the construction site by ground transportation. Once the gantry system is in place, construction would involve hoisting the segments from the ground and installing and tensioning the pre-stressing tendons to create the box girder (Figure 2-56).
- Balanced cantilever segmental construction—In locations where construction would occur over existing facilities that prevent equipment and temporary supports on the ground, balanced cantilever segmental construction may be used. Under this construction method, box girder segments (12-foot segments weighing less than 70 tons) that are either precast or cast in place would be placed in a symmetrical fashion around a bent column. The segments would be anchored at the ends by cantilever tendons in the deck slab, with midspan tendons balancing the weight between two cantilevers (Figure 2-57). Precast segments would be precast off-site, transported to the construction site, and installed incrementally onto a portion of the existing cantilever using ground cranes, hoisting devices, or a self-launching gantry. Segments can also be cast in place and installed two at a time, one at each end of the balanced cantilever. Segments generated by casting in place are generally longer than those in precast construction because they do not need to be transported to the construction site.
- Cast-in-place construction on falsework—The method involves creating a suspended formwork with either a launching girder or gantry system. Once the formwork is in position and reinforcements and pre-stressing are placed, concrete is poured and the pre-stressing is stressed. The formwork is then removed and moved to the next segment (Figure 2-58).

Construction of road crossings and bridges would be similar to the approach for aerial structures. The superstructure would likely be built using precast, pre-stressed, concrete girders and cast-in-place deck. Approaches to bridges would be earthwork embankments, mechanically stabilized earth wall, or other retaining structures.



Source: Authority 2019d

MAY 2017

**Figure 2-55 Full-Span Precast Construction on Taiwan HSR**



Source: Authority 2019d

MAY 2017

**Figure 2-56 Span-by-Span Precast Segmental Construction**



Source: Authority 2019d

MAY 2017

**Figure 2-57 Balanced Cantilever Segmental Construction**



Source: Authority 2019d

MAY 2017

**Figure 2-58 Cast-in-Place Construction on Formwork**

Crossings of existing railroads, roads, and the HSR would be built on the line of the existing road or offline at some locations. When built online, the existing road would be closed or temporarily diverted. When built offline, the existing road would be maintained in use until the new crossing is completed. Single tracking of VTA service would be necessary during construction of the SR 87 bridge under Alternative A. The following project features are necessary for VTA to modify operations during construction: a new crossover with two powered switches south of Tamien Station, provision of power to six existing switches, and installation of track signals at these new and existing powered switches. Where HSR would cross over existing railroads, the Authority would coordinate with the rail operators to avoid operational impacts during construction.

### **2.10.3.7 Roadway Modifications**

The most common type of roadway modification within the Project Section would be the installation of four-quadrant gates at at-grade crossings, required at 40 at-grade crossings under Alternative A and 38 at-grade crossings under Alternative B (see Table 2-14). The installation of four-quadrant gates at each at-grade crossing would occur within roadway rights-of-way over a period of 2 to 4 weeks.

Construction of the project alternatives would also involve roadway reconstructions at several locations. Portions of Tunnel Avenue and the existing Tunnel Avenue grade separation in Brisbane would require relocation under both alternatives. Roadway work associated with the project would be done using conventional methods in the following sequence as appropriate: demolition, utility relocation, excavation, grading, placing aggregate base, building concrete curb and gutter, and placing concrete or asphalt concrete top surface base and top surfaces. It is anticipated that full and partial street closures would be needed for the reconstruction of roadways. However, it is assumed that major diversions to the existing roadways to be grade separated would be avoided or minimized if they are necessary. Detours and temporary traffic control measures would be required so traffic circulation could be maintained during construction. Volume 2, Appendix 2-A illustrates additional roadway modifications that would be necessary under the project alternatives.

## 2.11 Permits

The Authority has entered into agreements with environmental resource agencies to facilitate the environmental permitting required during final design and construction. These agreements are intended to identify the Authority's responsibilities in meeting the permitting requirements of the federal, state, and regional environmental resource agencies.

An MOU was established in 2010 between the FRA, Authority, USACE, and USEPA (FRA et al. 2010) regarding integration of NEPA, CWA Section 404, and Rivers and Harbors Act Section 14 processes. In addition, the Authority and FRA entered into a Section 106 Programmatic Agreement with the California State Historic Preservation Officer in 2011 to establish the process for considering impacts on historic properties during project-level environmental reviews. An MOU was established between the Authority and the State Water Resources Control Board regarding items that would require a Complete Application for CWA Section 401 Certification and/or Waste Discharge Requirements, the delineation of nonfederal wetlands and other surface waters of the state that are not waters of the U.S., and any future amendments to the existing State Water Resources Control Board requirements regarding applications and delineation methods.

Table 2-26 shows the major environmental reviews, permits, and approvals that may be required for the project. The table identifies each agency's status as a NEPA cooperating agency or CEQA responsible agency. As a state agency, the Authority is exempt from local permit requirements; however, to coordinate construction activities with local jurisdictions, the Authority plans to pursue local permits as part of construction processes consistent with local ordinances. The agencies identified in the table are anticipated to rely on the EIR/EIS documents to support their permitting and approval processes. Other approvals may require new specific documentation.



**Table 2-26 Potential Major Environmental Permits and Approvals**

Agency	Permit/Approval
<b>Federal</b>	
U.S. Army Corps of Engineers (NEPA Cooperating Agency)	<ul style="list-style-type: none"> <li>▪ Section 404 Permit for Discharge of Dredge or Fill Materials into Waters of the U.S., including wetlands under the Clean Water Act of 1972</li> <li>▪ Section 10 Permit for Construction of any Structure in or over any Navigable Water of the United States under the Rivers and Harbors Act of 1899</li> <li>▪ Section 14 of the Rivers and Harbors Act of 1899 (“Section 408”) permission to alter or modify a facility or feature of any federal project levee or federally regulated flood control system</li> </ul>
U.S. Department of Transportation/Federal Railroad Administration	<ul style="list-style-type: none"> <li>▪ Constructive use determinations under Section 4(f) of the U.S. Department of Transportation Act of 1966</li> <li>▪ General Conformity Determination</li> </ul>
U.S. Department of Interior/National Park Service	<ul style="list-style-type: none"> <li>▪ Section 6(f) of the Land and Water Conservation Fund Act of 1965</li> </ul>
U.S. Advisory Council on Historic Preservation and the California State Historic Preservation Office	<ul style="list-style-type: none"> <li>▪ Section 106 Consultation (National Historic Preservation Act of 1966) and Memorandum of Agreement</li> </ul>
U.S. Environmental Protection Agency	<ul style="list-style-type: none"> <li>▪ Review of environmental impact statement under Clean Air Act Section 309</li> <li>▪ Review of environmental justice conclusions</li> <li>▪</li> </ul>
U.S. Fish and Wildlife Service	<ul style="list-style-type: none"> <li>▪ Section 7 Consultation and Biological Opinion/Incidental Take Statement pursuant to the Endangered Species Act of 1973</li> </ul>
National Oceanic and Atmospheric Administration, National Marine Fisheries Service	<ul style="list-style-type: none"> <li>▪ Section 7 Consultation and Biological Opinion/Incidental Take Statement pursuant to the Endangered Species Act of 1973</li> </ul>
Surface Transportation Board (NEPA Cooperating Agency)	<ul style="list-style-type: none"> <li>▪ Authority to build and operate new rail line</li> </ul>
Federal Emergency Management Agency	<ul style="list-style-type: none"> <li>▪ Conditional Letter of Map Revision</li> <li>▪ Letter of Map Revision</li> <li>▪ No-Rise Certification for floodways</li> </ul>
<b>State</b>	
California Department of Fish and Wildlife (CEQA Responsible Agency)	<ul style="list-style-type: none"> <li>▪ California Department of Fish and Wildlife Section 1602 Lake and Streambed Alteration Agreement</li> <li>▪ Incidental Take Permit under Section 2081 of the California Fish and Game Code</li> </ul>
Caltrans (CEQA Responsible Agency)	<ul style="list-style-type: none"> <li>▪ Caltrans encroachment permits</li> </ul>
California Public Utilities Commission (CEQA Responsible Agency)	<ul style="list-style-type: none"> <li>▪ Approval for construction and operation of railroad crossings of public road and ministerial Notice of Construction or discretionary Permit to Construct associated with network upgrades to PG&amp;E facilities</li> </ul>
California State Historic Preservation Office	<ul style="list-style-type: none"> <li>▪ Section 106 Consultation (National Historic Preservation Act of 1966)</li> </ul>

Agency	Permit/Approval
San Francisco Bay Conservation and Development Commission (CEQA Responsible Agency)	<ul style="list-style-type: none"> <li>▪ Regionwide, Administrative, or Major Permit</li> </ul>
State Water Resources Control Board, San Francisco Bay Regional Water Quality Control Board (CEQA Responsible Agency)	<ul style="list-style-type: none"> <li>▪ Section 401 Water Quality Certification under the Clean Water Act of 1972</li> <li>▪ Construction General Permit (Order No. Order 2009-0009-DWQ)</li> <li>▪ Industrial General Permit (Order No. 2014-0057-DWQ)</li> <li>▪ Caltrans Statewide MS4 Permit (Order No. 2012-0011-DWQ)</li> <li>▪ Phase I MS4/Municipal Regional Permit (Order No. R2-2015-0049)</li> <li>▪ Phase II MS4 Permit (Order No. 2013-0001-DWQ)</li> <li>▪ Volatile Organic Compound and Fuel General Permit (Order No. R2-2012-0012)</li> <li>▪ Groundwater General Permit (Order No. R2-2012-0060)</li> <li>▪ Discharges with Low Threat to Water Quality (Order No. R3-2011-0223)</li> <li>▪ Dewatering and Other Low Threat Discharges (Order No. R5-2013-0074)</li> <li>▪ Spill Prevention, Control, and Countermeasure Plan (part of Section 402 process)</li> <li>▪ Stormwater Construction and Operation Permit</li> </ul>
<b>Regional</b>	
Bay Area Air Quality Management District (CEQA Responsible Agency)	<ul style="list-style-type: none"> <li>▪ Rule 201 General Permit Requirements, Rule 403 Fugitive Dust, Rule 442 Architectural Coatings, Rule 902 Asbestos, and Rule 9510 Indirect Source Review</li> </ul>

Caltrans = California Department of Transportation  
 CEQA = California Environmental Quality Act  
 MS4 = municipal separate storm sewer system  
 NEPA = National Environmental Policy Act  
 PG&E = Pacific Gas and Electric Company