

# San Jose to Merced Project Section: San Jose to Central Valley Wye

Roadway; Maintenance of Way; Tunnels

Alternative 3 - Viaduct to East Gilroy  
Final EIR/S: Volume III

Preliminary Engineering for Project Definition  
2021 Record Set – November 2021

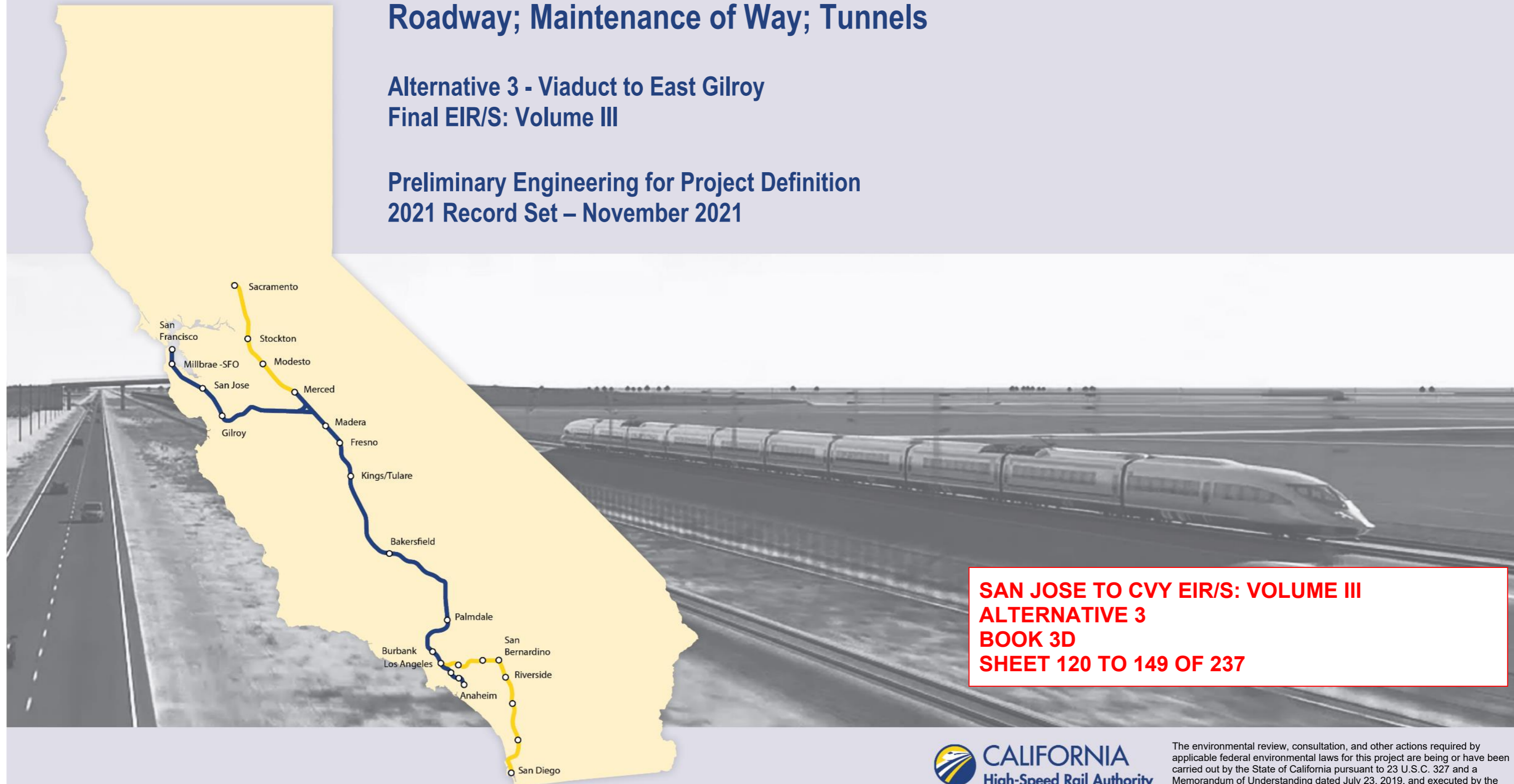

**SAN JOSE TO CVY EIR/S: VOLUME III  
ALTERNATIVE 3  
BOOK 3D  
SHEET 120 TO 149 OF 237**

**ALTERNATIVE 3 - VIADUCT TO EAST GILROY**

BOOK	SHEET NO	DRAWING NO	SUBSECTION	GEOGRAPHIC LOCATION	ALIGNMENT OR FEATURE	SHEET DESCRIPTION	ADDITIONAL DESCRIPTION
------	----------	------------	------------	---------------------	----------------------	-------------------	------------------------

**COVER, INDEX OF DRAWING AND KEY MAPS**

BOOK 3D	A	COVER	SAN JOSE TO MERCED SECTION	N/A	SAN JOSE TO CENTRAL VALLEY WYE	ALTERNATIVE 3	VIADUCT TO EAST GILROY
BOOK 3D	B	GE-A0305	ENTIRE ALTERNATIVE	GRADE SEPARATIONS/MAINTENANCE OF WAY, TUNNELS	INDEX OF DRAWING	SHEET 5 OF 7	
BOOK 3D	C	GE-D0301	GENERAL	ENTIRE ALTERNATIVE	KEY MAP	COMPOSITE PLAN	
BOOK 3D	D	GE-D0302	GENERAL	ENTIRE ALTERNATIVE	KEY MAP	SYSTEMS SITES	

**ROADWAY**

**PACHECO PASS**

BOOK 3D	120	CV-T0401	MONTEREY CORRIDOR	SR87, WILLOW ST	VIADUCT / AT-GRADE	GRADE SEPARATION LAYOUT, PROFILE, & CROSS SECTIONS	SR87 ON-RAMP
---------	-----	----------	-------------------	-----------------	--------------------	--	--------------

**SAN JOAQUIN VALLEY**

BOOK 3D	121	CV-S1601	SAN JOAQUIN VALLEY	MONTEREY RD, INGOMAR GRADE	HENRY MILLER ROAD	CIVIL DETAILS	
BOOK 3D	122	CV-T1603	SAN JOAQUIN VALLEY	VOLTA RD, HENRY MILLER RD	HENRY MILLER ROAD	GRADE SEPARATION LAYOUT, PROFILE, & CROSS SECTIONS	HENRY MILLER ROAD
BOOK 3D	123	CV-T1604	SAN JOAQUIN VALLEY	HENRY MILLER ACCESS	HENRY MILLER ROAD	GRADE SEPARATION LAYOUT, PROFILE, & CROSS SECTIONS	HENRY MILLER ACCESS
BOOK 3D	124	CV-T1606	SAN JOAQUIN VALLEY	HENRY MILLER RD AT MERCY SPRINGS RD	HENRY MILLER ROAD	GRADE SEPARATION LAYOUT, PROFILE, & CROSS SECTIONS	MERCY SPRINGS ROAD
BOOK 3D	125	CV-T1609	SAN JOAQUIN VALLEY	DELTA RD	HENRY MILLER ROAD	GRADE SEPARATION LAYOUT, PROFILE, & CROSS SECTIONS	DELTA ROAD
BOOK 3D	126	CV-T1610	SAN JOAQUIN VALLEY	TURNER ISLAND RD AT HENRY MILLER RD	HENRY MILLER ROAD	GRADE SEPARATION LAYOUT, PROFILE, & CROSS SECTIONS	TURNER ROAD
BOOK 3D	127	CV-T1611	SAN JOAQUIN VALLEY	CARLUCCI RD	HENRY MILLER ROAD	GRADE SEPARATION LAYOUT, PROFILE, & CROSS SECTIONS	CARLUCCI ROAD
BOOK 3D	128	CV-T1612	SAN JOAQUIN VALLEY	HUTCHINS RD	HENRY MILLER ROAD	GRADE SEPARATION LAYOUT, PROFILE, & CROSS SECTIONS	HUTCHINS ROAD

**MAINTENANCE OF WAY**

BOOK 3D	129	MY-B0906	MORGAN HILL AND GILROY	CARNADERO AVE TO SHELDON AVE	VIADUCT TO DOWNTOWN GILROY	MAINTENANCE OF WAY FACILITY	DETAIL PLAN
BOOK 3D	130	MY-B0907	MORGAN HILL AND GILROY	CARNADERO AVE TO SHELDON AVE	VIADUCT TO DOWNTOWN GILROY	MAINTENANCE OF WAY FACILITY	TYPICAL SECTIONS
BOOK 3D	131	MY-B0908	MORGAN HILL AND GILROY	N/A	VIADUCT TO DOWNTOWN GILROY	MAINTENANCE OF WAY FACILITY	UPRR PROFILE AND GEOMETRY FOR MOWF
BOOK 3D	132	MY-B1106	MORGAN HILL AND GILROY	N/A	VIADUCT TO EAST GILROY	MAINTENANCE OF WAY FACILITY	DETAIL PLAN
BOOK 3D	133	MY-B1107	MORGAN HILL AND GILROY	SR 152, JONES CREEK	VIADUCT TO EAST GILROY	MAINTENANCE OF WAY FACILITY	TYPICAL SECTIONS
BOOK 3D	134	MY-B1108	MORGAN HILL AND GILROY	N/A	VIADUCT TO EAST GILROY	MAINTENANCE OF WAY FACILITY	MOWF TRANSITION TRACK PROFILE AND GEOMETRY

**TUNNELS - PACHECO PASS**

BOOK 3D	135	TN-D1301	PACHECO PASS	PACHECO PASS RD	TUNNEL	TUNNEL 1 - PORTAL 1	
BOOK 3D	136	TN-D1302	PACHECO PASS	SR 152	TUNNEL	TUNNEL 1 - PORTAL 2	
BOOK 3D	137	TN-D1404	PACHECO PASS	N/A	TUNNEL	TUNNEL 2 - PORTAL 1	
BOOK 3D	138	TN-D1405	PACHECO PASS	ACCESS RD 1	TUNNEL	TUNNEL PORTAL 2 ACCESS ROAD	
BOOK 3D	139	TN-D1406	PACHECO PASS	CALIFORNIA AQUEDUCT	TUNNEL	TUNNEL PORTAL 2 ACCESS ROAD	
BOOK 3D	140	TN-D1407	PACHECO PASS	ACCESS RD 2	TUNNEL	TUNNEL PORTAL 2 ACCESS ROAD	
BOOK 3D	141	TN-D1408	PACHECO PASS	N/A	TUNNEL	LONGITUDINAL PROFILE	
BOOK 3D	142	TN-D1409	PACHECO PASS	N/A	TUNNEL	GRADING DETAIL	
BOOK 3D	143	TN-D1410	PACHECO PASS	N/A	TUNNEL	GRADING DETAIL	
BOOK 3D	144	TN-D1411	PACHECO PASS	N/A	TUNNEL	GRADING DETAIL	
BOOK 3D	145	TN-D1412	PACHECO PASS	N/A	TUNNEL	GRADING DETAIL	
BOOK 3D	146	TN-D1413	PACHECO PASS	I-5, FAHEY RD	TUNNEL	GRADING DETAIL	
BOOK 3D	147	TN-D1414	PACHECO PASS	N/A	TUNNEL	TUNNEL 2 - PORTAL 1	SECTIONS
BOOK 3D	148	TN-D1415	PACHECO PASS	N/A	TUNNEL	TUNNEL 2 - PORTAL 2	APPROACH 1
BOOK 3D	149	TN-D1416	PACHECO PASS	N/A	TUNNEL	TUNNEL 2 - PORTAL 2	APPROACH 2

**SAN JOSE TO CVY EIR/S: VOLUME III  
ALTERNATIVE 3  
BOOK 3D  
SHEET B**

11/24/2021 4:42:17 PM CAHSRP.tbl printer.plt c:\voad\lib\pw\hntb\_josyang\_46037\_consr\dms22197\JM-GE-A0305.dgn

REV	DATE	BY	CHK	APP	DESCRIPTION

DESIGNED BY	
DRAWN BY	
CHECKED BY	
IN CHARGE	
DATE	

**2021 RECORD SET PEPP**  
NOVEMBER 30, 2021  
**NOT FOR CONSTRUCTION**

**HNTB**  
1111 Broadway  
9th Floor  
Oakland, CA 94607



**CALIFORNIA HIGH-SPEED TRAIN PROJECT  
SAN JOSE TO MERCED  
ALTERNATIVE 3  
INDEX OF DRAWING  
SHEET 5 OF 7**

CONTRACT NO.	HSR15-34
DRAWING NO.	GE-A0305
SCALE	NONE
SHEET NO.	

**ALTERNATIVE 3 BOOK INDEX**

- BOOK 3A: COMPOSITE PLAN, PROFILE AND CROSS SECTIONS
- BOOK 3B: COMPOSITE PLAN, PROFILE AND CROSS SECTIONS, STATIONS
- BOOK 3C: STRUCTURES, ROADWAY
- BOOK 3D: ROADWAY, MAINTENANCE OF WAY, TUNNELS - PACHECO PASS
- BOOK 3E: CONSTRUCTION STAGING
- BOOK 3F: ALIGNMENT DATA TABLES

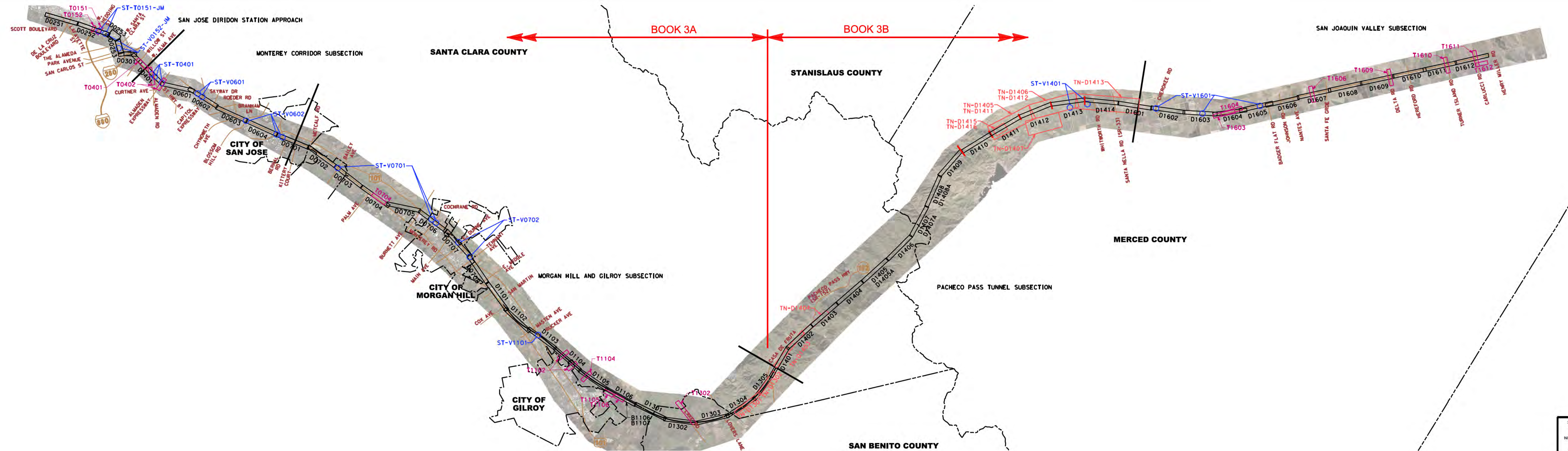

**NOTE:**  
ALTERNATIVE KEY MAP SHOWN SIDE BY SIDE FOR CLARITY.

**LEGEND**  
**KEY MAP LEGEND**

	AERIAL ORTHO-PHOTO
	COMPOSITE ROLL PLOTS
	GRADE SEPARATION ROLL PLOTS
	TUNNEL ROLL PLOTS
	STRUCTURES ROLL PLOTS
	SECTION BREAK
	CITY LIMITS
	COUNTY LINE
	EXISTING ROAD

**SAN JOSE TO CVY EIR/S: VOLUME III**  
**ALTERNATIVE 3**  
**BOOK 3D**  
**SHEET C**

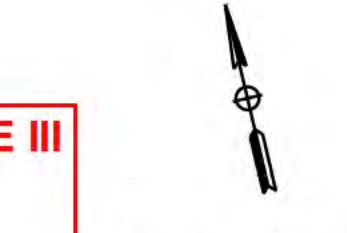

2021 RECORD SET PERD NOVEMBER 30, 2021 NOT FOR CONSTRUCTION	 1111 Broadway 9th Floor Oakland, CA 94607		<b>CALIFORNIA HIGH-SPEED TRAIN PROJECT</b> <b>SAN JOSE TO MERCED</b> ALTERNATIVE 3 KEY MAP COMPOSITE PLAN	CONTRACT NO. MSR15-34 DRAWING NO. CE-D0301 SCALE AS SHOWN SHEET NO.
---	---	--	---	--

10/27/2025 10:51:31 AM C:\Users\hntb\OneDrive\Documents\Projects\San Jose to Merced\Map\20251105\Map\20251105-00302.dwg



FOR ALIGNMENT LOCATION SEE KEP MAP DRAWING GE-00301

**ALTERNATIVE 3 - VIADUCT TO EAST GILROY**

6000 0 6000 12000  
1"=2000'

**ALTERNATIVE 3**

Station	Station Power Facility (PF)	PS-P	PS-F	PS-T	PS-B	PS-C	PS-D	PS-E	PS-F	PS-G	PS-H	PS-I	PS-J	PS-K	PS-L	PS-M	PS-N	PS-O	PS-P	PS-Q	PS-R	PS-S	PS-T	PS-U	PS-V	PS-W	PS-X	PS-Y	PS-Z	
D0301																														
D0601																														
D1101																														
D1301																														
D1401																														
D1601																														

**ALTERNATIVE 3 (CONTINUED)**

Station	Station Power Facility (PF)	PS-P	PS-F	PS-T	PS-B	PS-C	PS-D	PS-E	PS-F	PS-G	PS-H	PS-I	PS-J	PS-K	PS-L	PS-M	PS-N	PS-O	PS-P	PS-Q	PS-R	PS-S	PS-T	PS-U	PS-V	PS-W	PS-X	PS-Y	PS-Z		
D1610																															
D1611																															
D1612																															

**ALTERNATIVE 3 (CONTINUED)**

Station	Station Power Facility (PF)	PS-P	PS-F	PS-T	PS-B	PS-C	PS-D	PS-E	PS-F	PS-G	PS-H	PS-I	PS-J	PS-K	PS-L	PS-M	PS-N	PS-O	PS-P	PS-Q	PS-R	PS-S	PS-T	PS-U	PS-V	PS-W	PS-X	PS-Y	PS-Z			
D1620																																
D1621																																
D1622																																

**ALTERNATIVE 3 (CONTINUED)**

Station	Station Power Facility (PF)	PS-P	PS-F	PS-T	PS-B	PS-C	PS-D	PS-E	PS-F	PS-G	PS-H	PS-I	PS-J	PS-K	PS-L	PS-M	PS-N	PS-O	PS-P	PS-Q	PS-R	PS-S	PS-T	PS-U	PS-V	PS-W	PS-X	PS-Y	PS-Z			
D1630																																
D1631																																
D1632																																

2021 RECORD SET PERD  
NOVEMBER 30, 2021  
NOT FOR CONSTRUCTION

HNTB  
1111 Broadway  
9th Floor  
Oakland, CA 94607

CALIFORNIA High-Speed Rail Authority

CALIFORNIA HIGH-SPEED TRAIN PROJECT  
SAN JOSE TO MERCED  
GENERAL KEY MAP  
SYSTEMS SITES

CONTRACT NO. MSR15-34  
DRAWING NO. GE-D0302  
SCALE AS SHOWN  
SHEET NO.

**SAN JOSE TO CVY EIR/S: VOLUME III**  
**ALTERNATIVE 3**  
**BOOK 3D**  
**SHEET D**

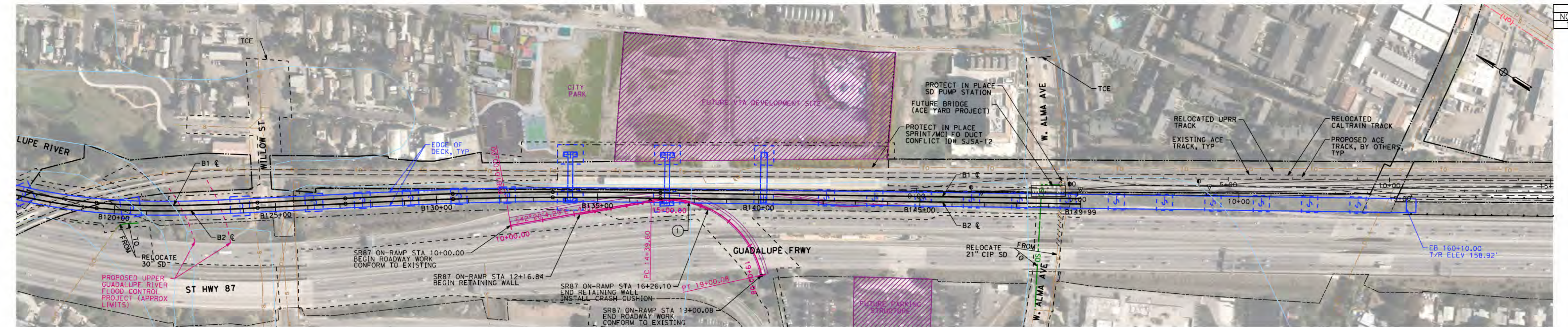

CURVE DATA SR87 ON-RAMP				
NO.	R	Δ	L	Δ
1	300	87°56'43.36"	460.481	289.430

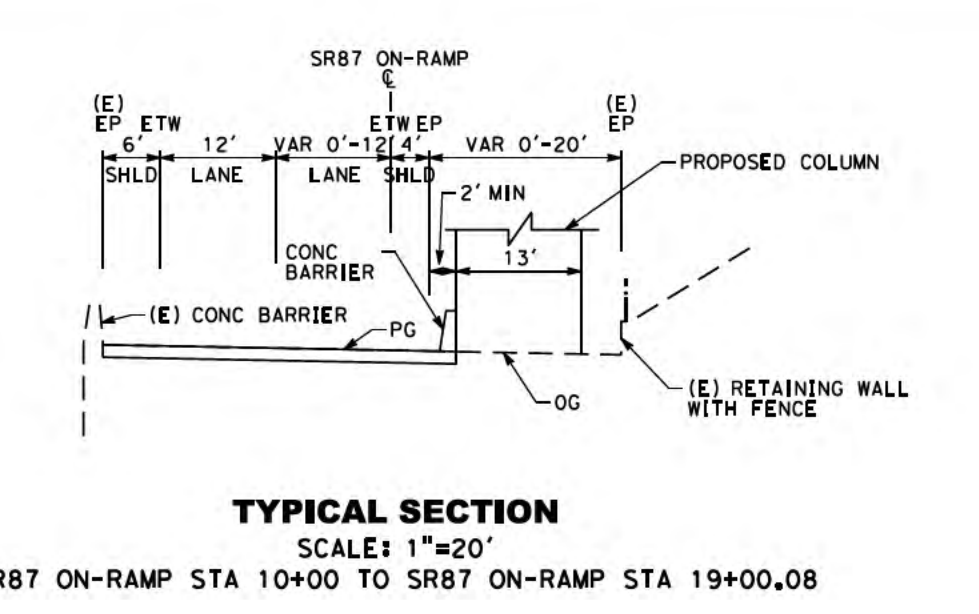
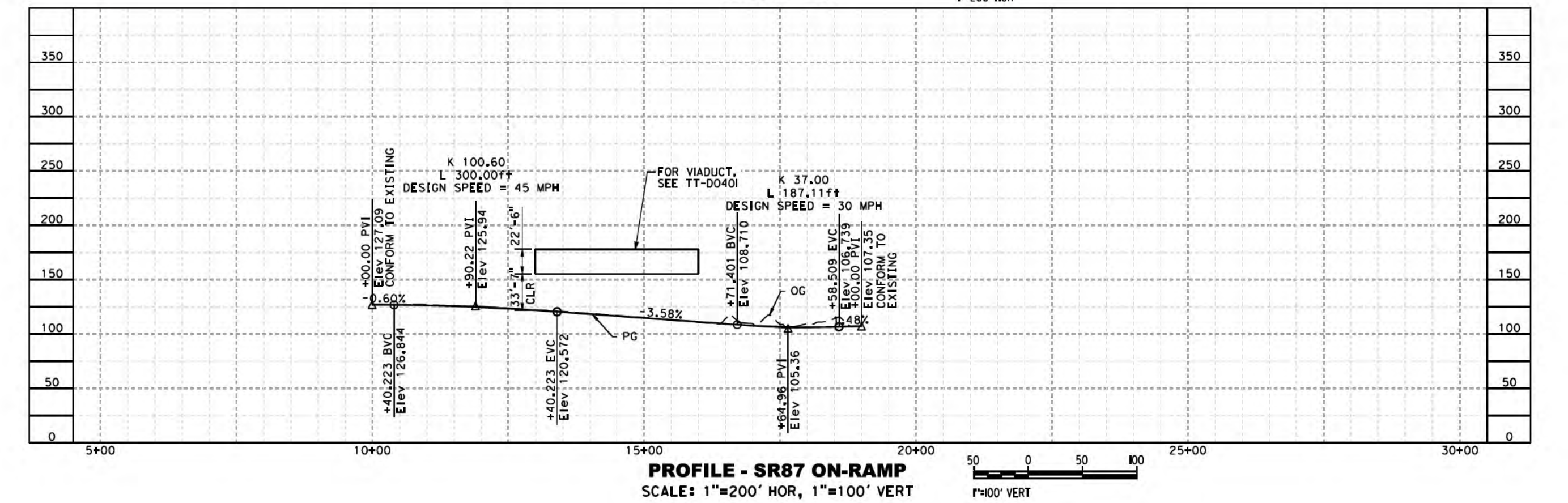

**NOTE:**  
1. REFER TO GENERAL NOTES SHEETS GE-B0001 AND GE-B0002 FOR NOTES.

**SAN JOSE TO CVY EIR/S: VOLUME III**  
**ALTERNATIVE 3**  
**BOOK 3D**  
**SHEET 120 OF 237**

2021 RECORD SET PBD NOVEMBER 30, 2021 NOT FOR CONSTRUCTION	<b>HNTB</b> 1111 Broadway 9th Floor Oakland, CA 94607		<b>CALIFORNIA HIGH-SPEED TRAIN PROJECT</b> <b>SAN JOSE TO MERCED</b> MONTEREY CORRIDOR VIADUCT/AT-GRADE GRADE SEPARATION LAYOUT, PROFILE, & CROSS SECTIONS SR87 ON-RAMP	CONTRACT NO. HSR15-34 DRAWING NO. CV-T0401 SCALE AS SHOWN SHEET NO.
--	--	--	--	---

I:\projects\15111\15111\_001\15111\_001\_001\15111\_001\_001\_001.dwg  
 11/30/2021 10:43:24 AM  
 15111\_001\_001\_001.dwg  
 11/30/2021 10:43:24 AM  
 15111\_001\_001\_001.dwg

10/27/2021 9:45:02 AM C:\Users\jrb\OneDrive\Documents\16032\_Cover\Sheet\16032\_Cover.dwg 16032\_Cover.dwg



**PROPOSED ACCESS ROAD TO MONTEREY ROAD**  
SCALE: 1"=200'

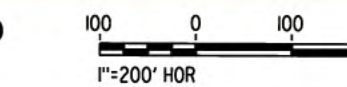

**PROPOSED ACCESS ROAD TO INGOMAR GRADE**  
SCALE: 1"=200'

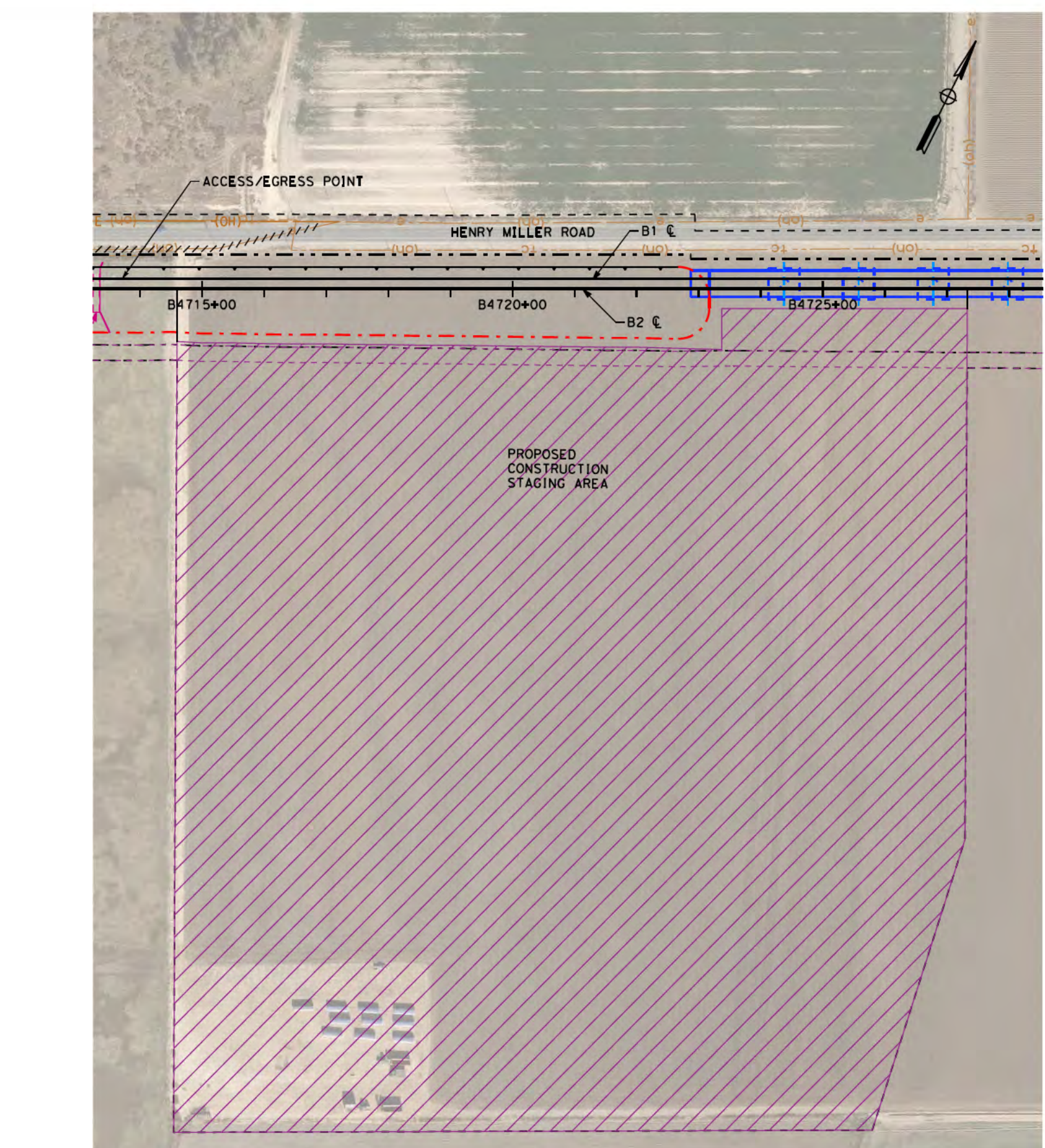
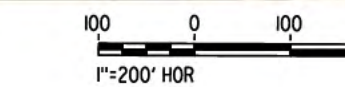

**PROPOSED CONSTRUCTION STAGING AREA  
AT STA B4714+60 TO STA B4727+32**  
SCALE: 1"=200'

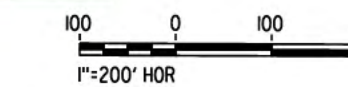

**NOTES:**  
1. REFER TO GENERAL NOTES SHEETS GE-B0001 AND GE-B0002 FOR NOTES.

**SAN JOSE TO CVY EIR/S: VOLUME III  
ALTERNATIVE 3  
BOOK 3D  
SHEET 121 OF 237**

2021 RECORD SET PBD NOVEMBER 30, 2021 NOT FOR CONSTRUCTION	<b>HNTB</b> 1111 Broadway 9th Floor Oakland, CA 94607		<b>CALIFORNIA HIGH-SPEED TRAIN PROJECT</b> <b>SAN JOSE TO MERCY</b> SAN JOAQUIN VALLEY HENRY MILLER ROAD CIVIL DETAILS	CONTRACT NO. HSR15-34 DRAWING NO. CV-S1601 SCALE AS SHOWN SHEET NO.
--	--	--	--	--

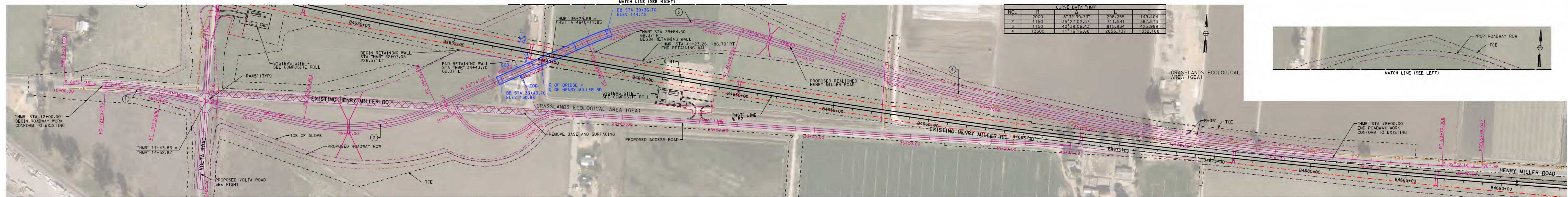

NO.	R	A	CHORD	AREA
1	2000	8° 32' 39.73"	298.255	149.404
2	1150	35° 27' 02.57"	711.541	367.573
3	1150	40° 39' 06.43"	816.934	425.989
4	13500	11° 16' 16.68"	2655.737	1332.168

**PLAN - HENRY MILLER "HMR"**  
SCALE: 1"=200'

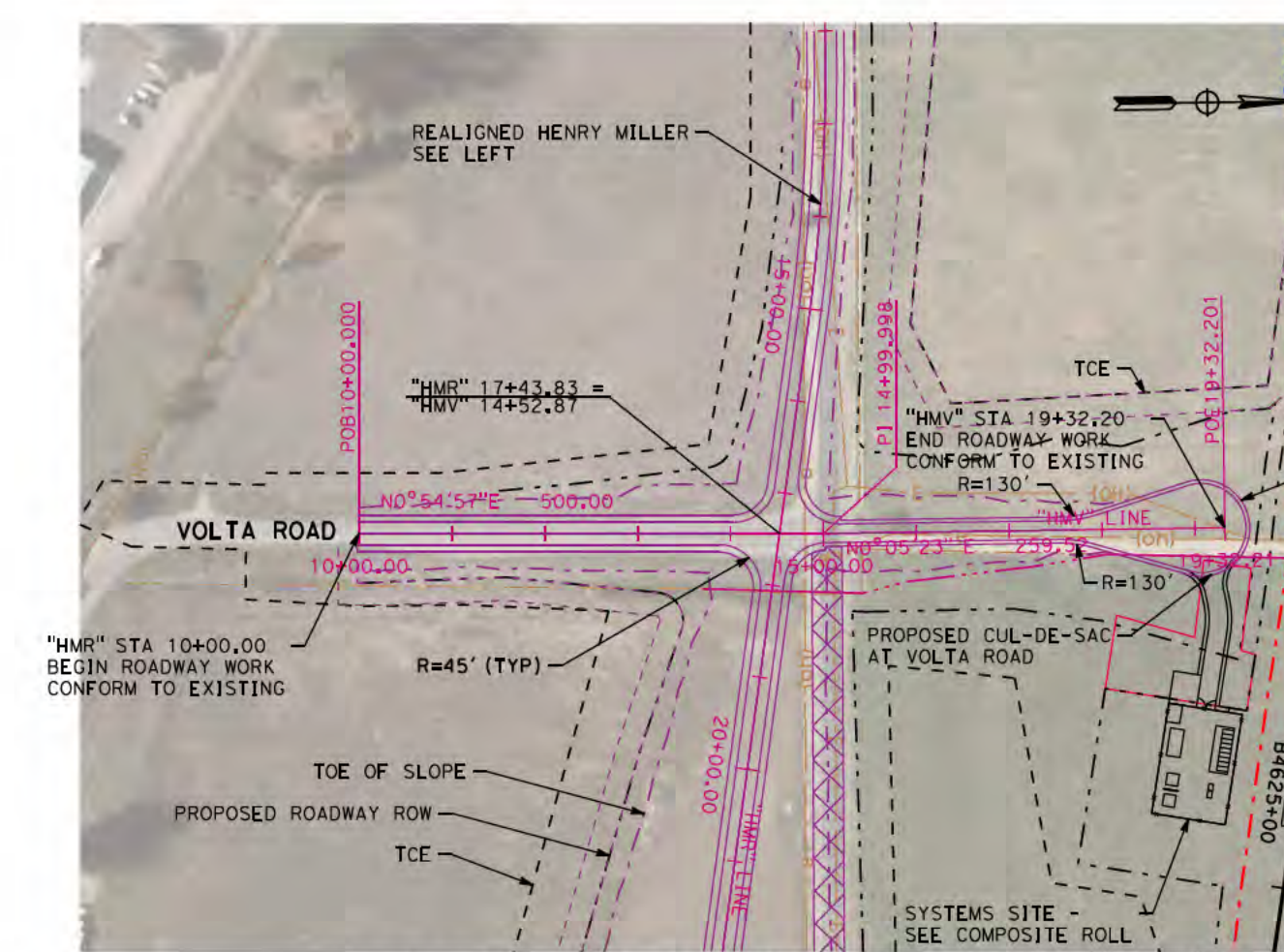

**PLAN - VOLTA RD TO HENRY MILLER "HMV"**  
SCALE: 1"=200'

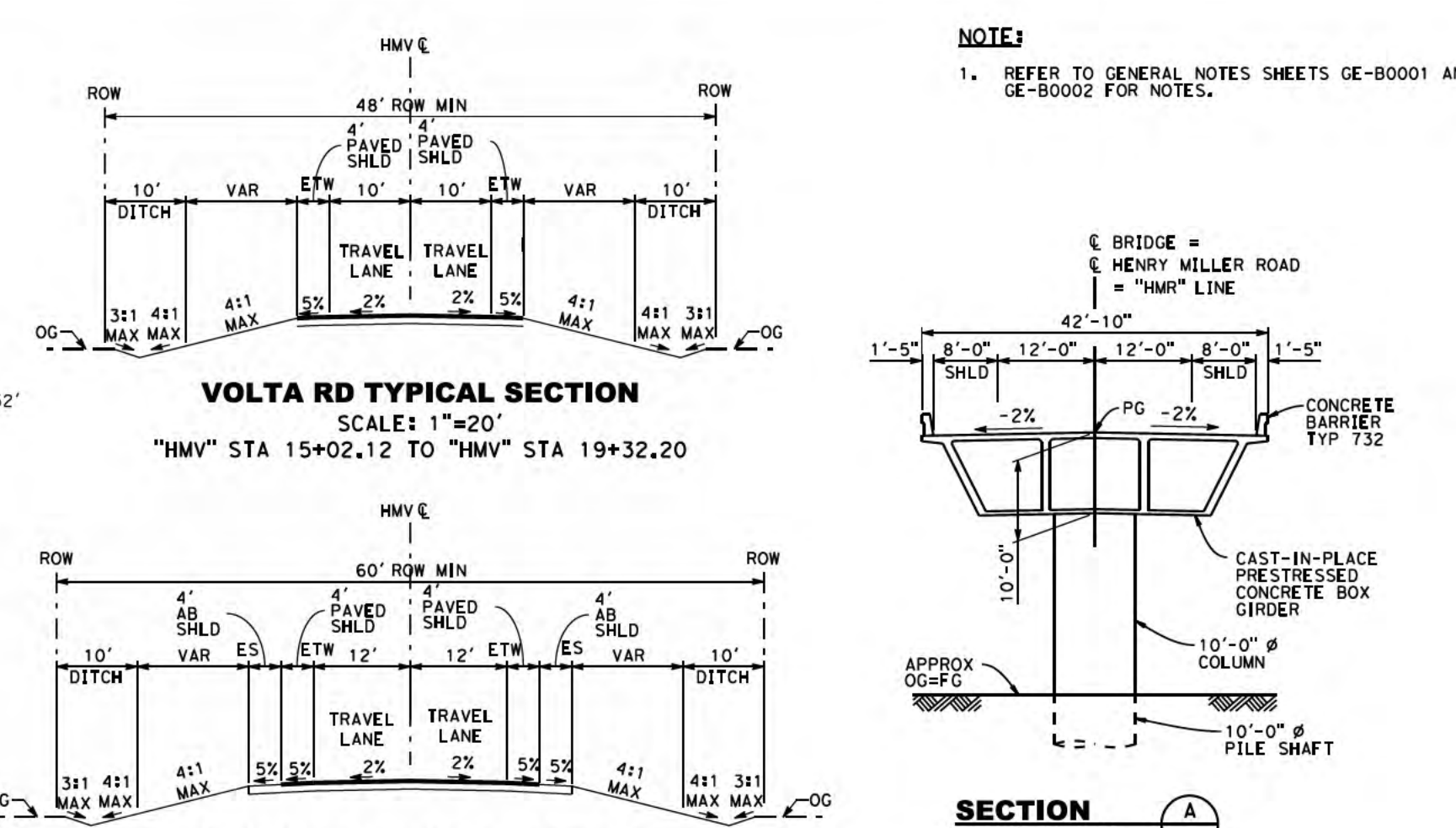

**VOLTA RD TYPICAL SECTION**  
SCALE: 1"=20'  
"HMV" STA 15+02.12 TO "HMV" STA 19+32.20

**VOLTA RD TYPICAL SECTION**  
SCALE: 1"=20'  
"HMV" STA 10+00.00 TO "HMV" STA 15+02.12

**HENRY MILLER RD TYPICAL SECTION**  
SCALE: 1"=20'  
"HMR" STA 12+00.00 TO "HMR" STA 33+20.70  
"HMR" STA 39+59.60 TO "HMR" STA 78+00.00

**SAN JOSE TO CVY EIR/S: VOLUME III**  
**ALTERNATIVE 3**  
**BOOK 3D**  
**SHEET 122 OF 237**

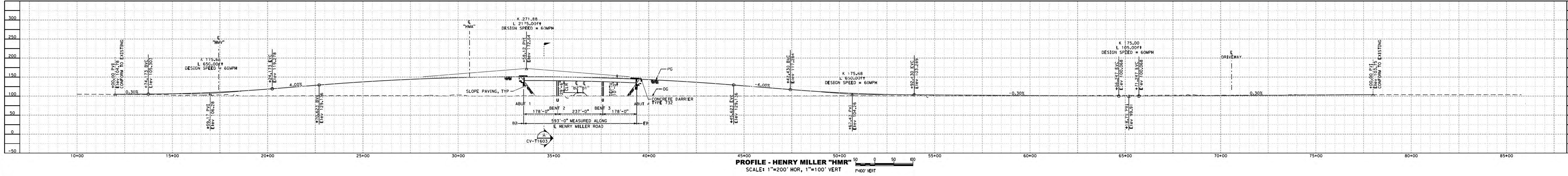

**PROFILE - HENRY MILLER "HMR"**  
SCALE: 1"=200' HOR, 1"=100' VERT

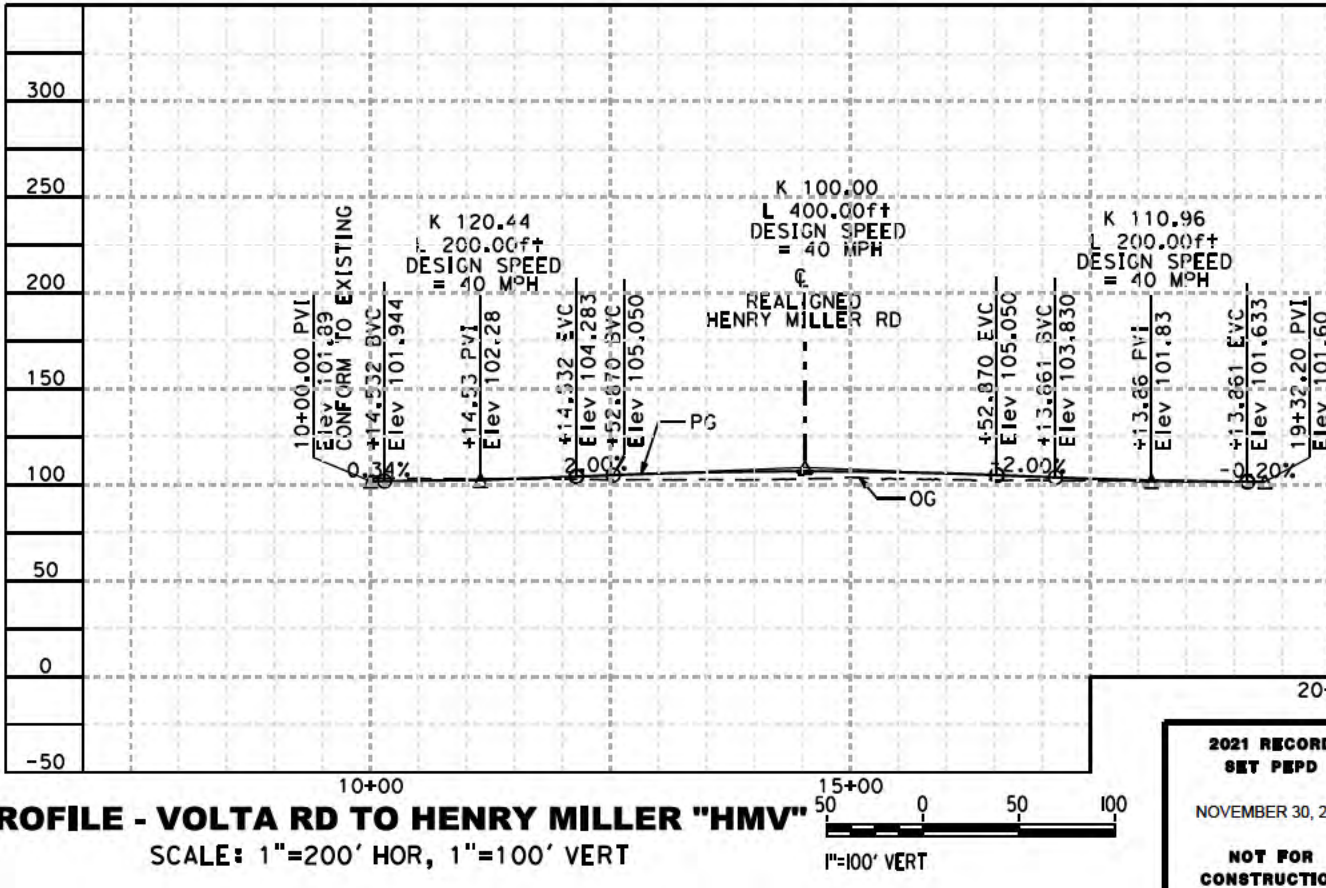

**PROFILE - VOLTA RD TO HENRY MILLER "HMV"**  
SCALE: 1"=200' HOR, 1"=100' VERT

2021 RECORD SET PERD  
NOVEMBER 30, 2021  
NOT FOR CONSTRUCTION

HNTB  
1111 Broadway  
9th Floor  
Oakland, CA 94607

CALIFORNIA High-Speed Rail Authority

**CALIFORNIA HIGH-SPEED TRAIN PROJECT**  
**SAN JOSE TO MERCED**  
SAN JOAQUIN VALLEY  
HENRY MILLER ROAD  
GRADE SEPARATION LAYOUT, PROFILE, & CROSS SECTIONS  
HENRY MILLER ROAD

CONTRACT NO. HSR15-34  
DRAWING NO. CV-T1603  
SCALE AS SHOWN  
SHEET NO.

**NOTE:**  
 1. REFER TO GENERAL NOTES SHEETS GE-B0001 AND GE-B0002 FOR NOTES.

CURVE DATA "HMA"				
NO.	R	Δ	L	T
1	250	106°43'46.43"	465.696	336.193
2	250	44°05'47.68"	192.408	101.252
3	10000	0°37'01.77"	107.714	53.858
4	10000	0°46'32.98"	135.408	67.705

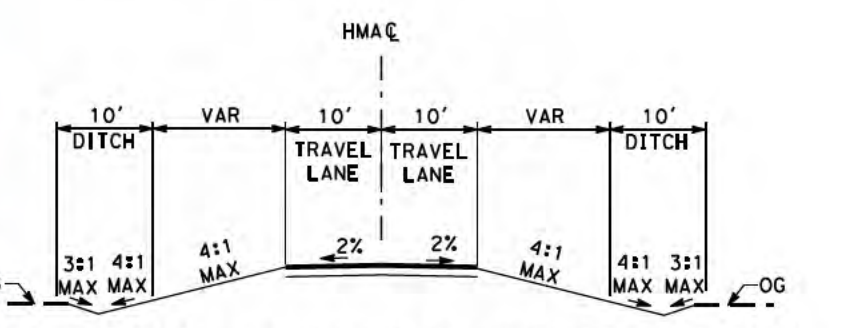

**HENRY MILLER ACCESS RD TYPICAL SECTION**  
 SCALE: 1"=20'  
 "HMA" STA 10+00.00 TO "HMA" STA 43+33.22

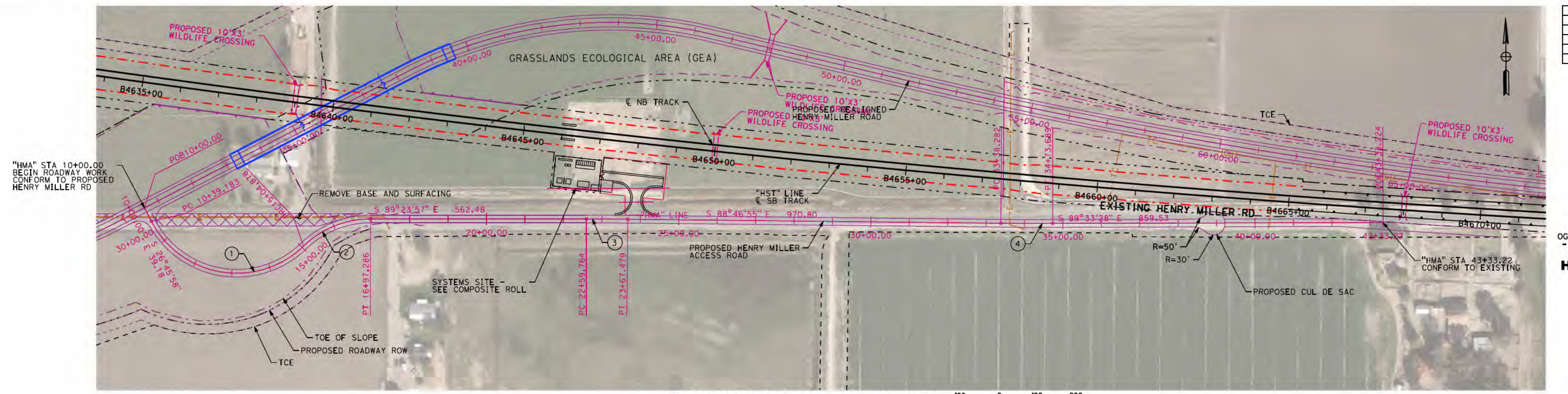

**PLAN - HENRY MILLER ACCESS "HMA"**  
 SCALE: 1"=200'  
 P=200' HOR

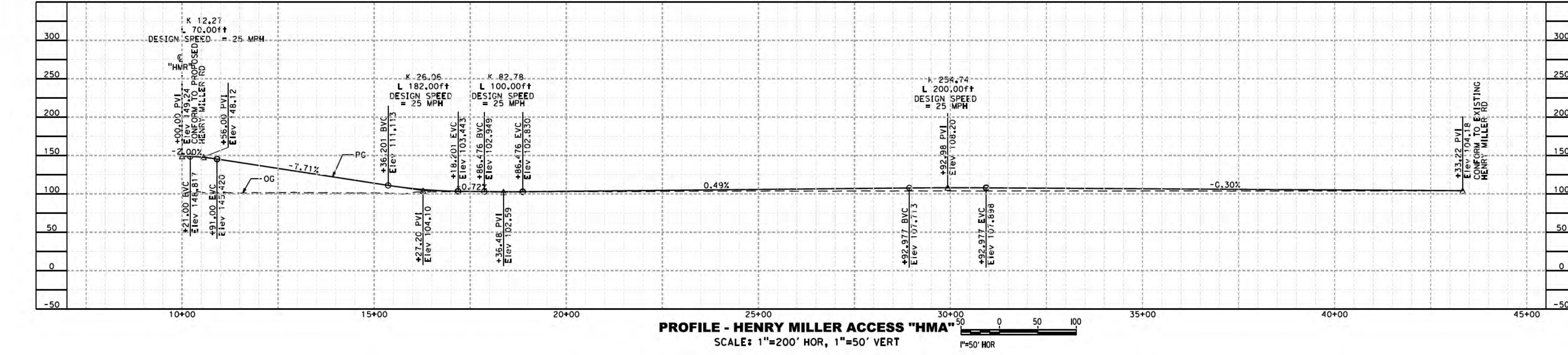

**PROFILE - HENRY MILLER ACCESS "HMA"**  
 SCALE: 1"=200' HOR, 1"=50' VERT  
 P=50' VERT

**SAN JOSE TO CVY EIR/S: VOLUME III**  
**ALTERNATIVE 3**  
**BOOK 3D**  
**SHEET 123 OF 237**

2021 RECORD SET PBD NOVEMBER 30, 2021 NOT FOR CONSTRUCTION	<b>HNTB</b> 1111 Broadway 9th Floor Oakland, CA 94607	<b>CALIFORNIA</b> High-Speed Rail Authority	<b>CALIFORNIA HIGH-SPEED TRAIN PROJECT</b> <b>SAN JOSE TO MERCED</b> SAN JOAQUIN VALLEY HENRY MILLER ROAD GRADE SEPARATION LAYOUT, PROFILE, & CROSS SECTIONS HENRY MILLER ACCESS	CONTRACT NO. HSR15-34 DRAWING NO. CV-T1604 SCALE AS SHOWN SHEET NO.
--	--	--	---	--

I:\coron\15166\15166001\15166001.dwg 11/30/2021 12:52:17 PM c:\cadd\pnt\_chap1.rtg c:\cadd\pnt\_chap1.rtg



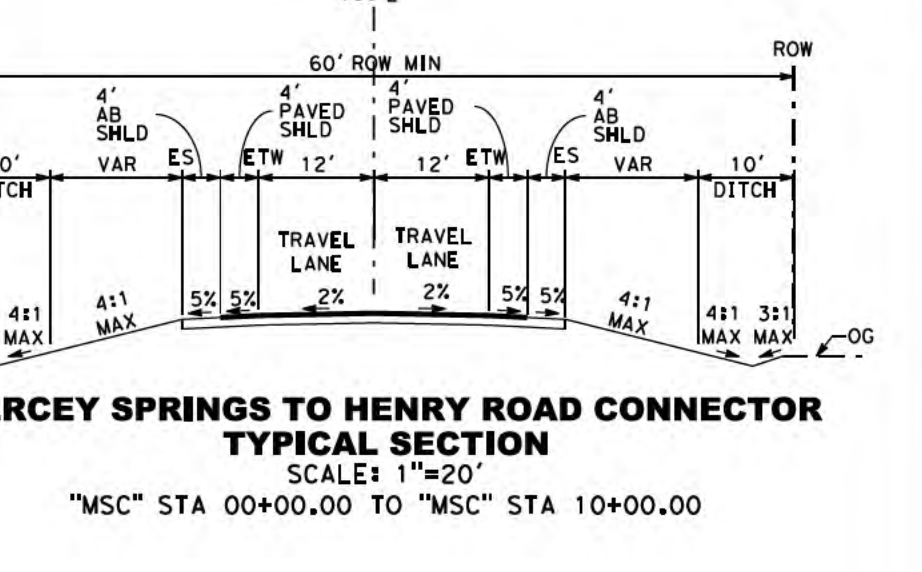
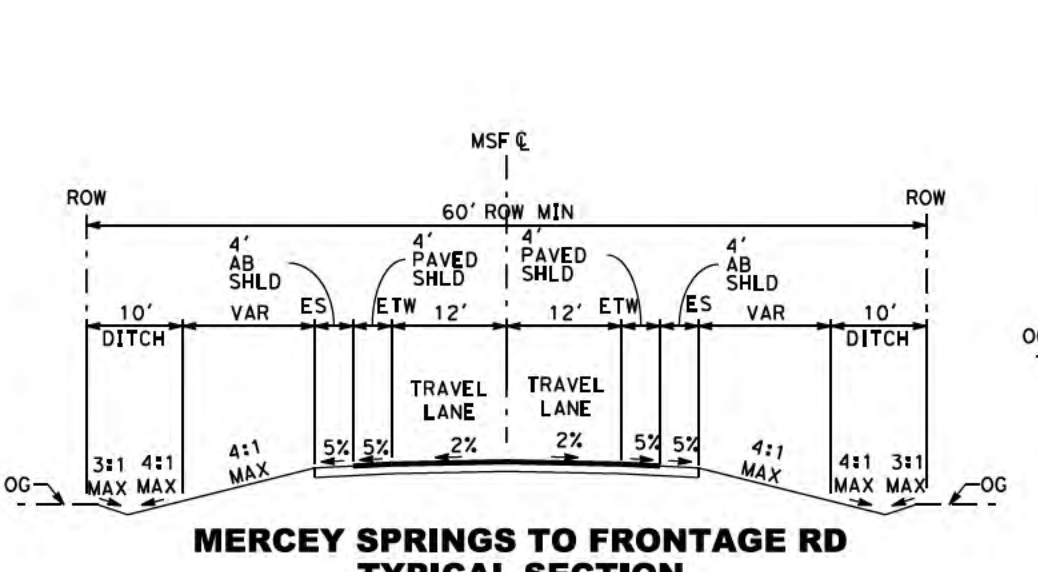
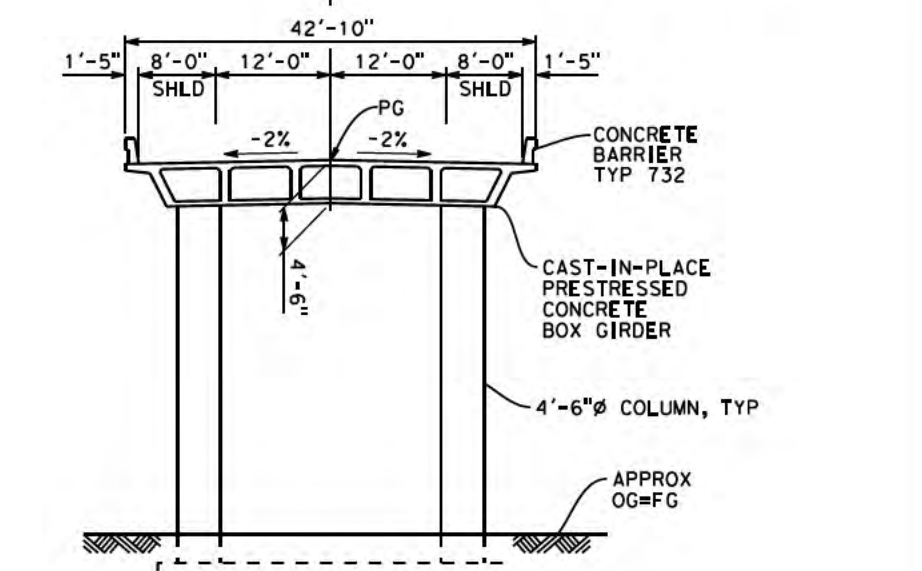
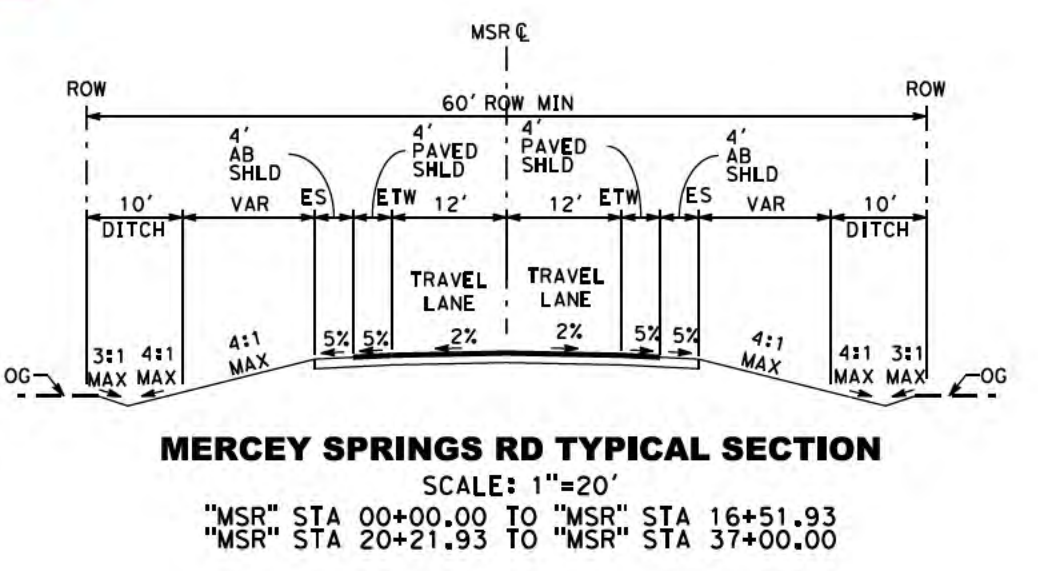
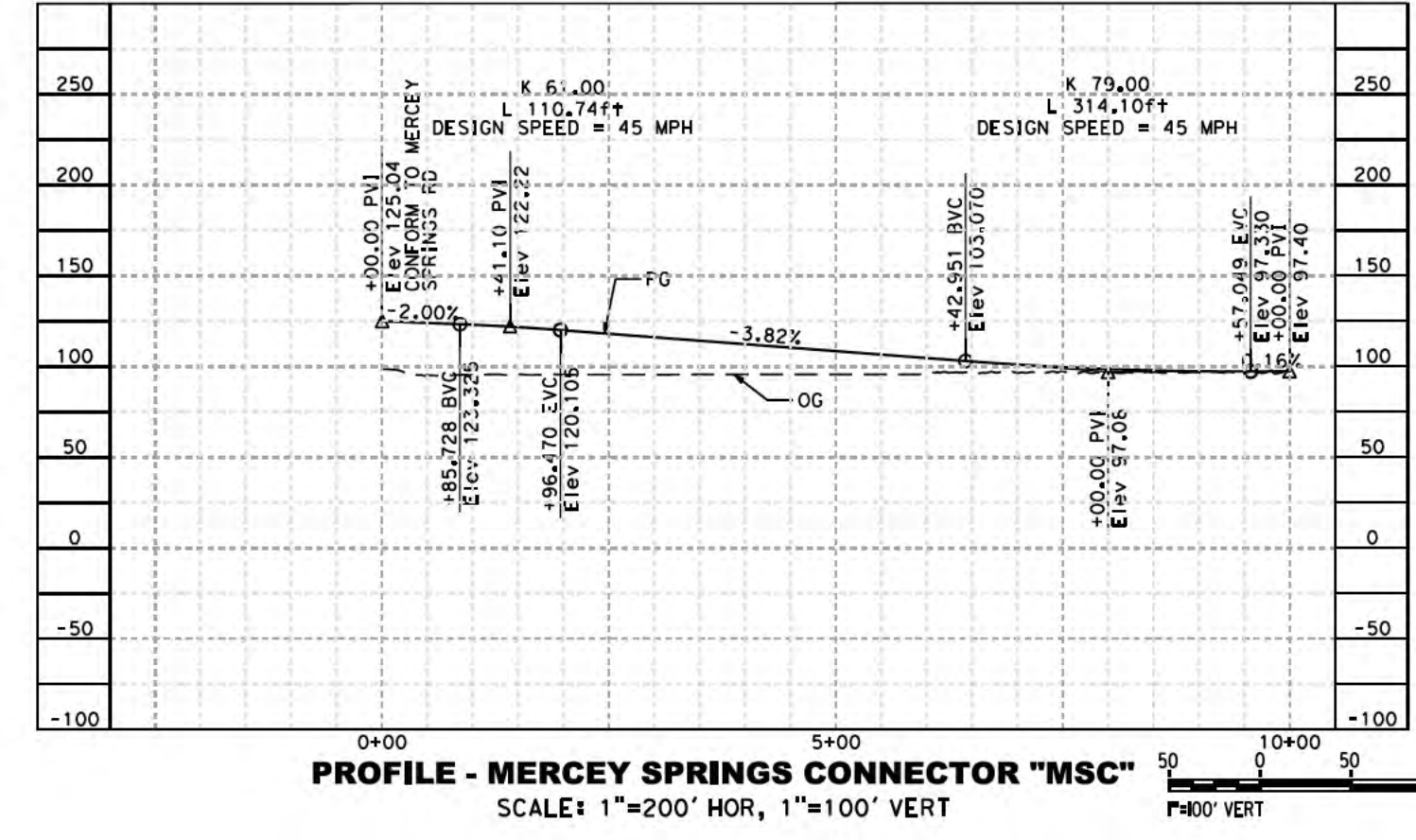
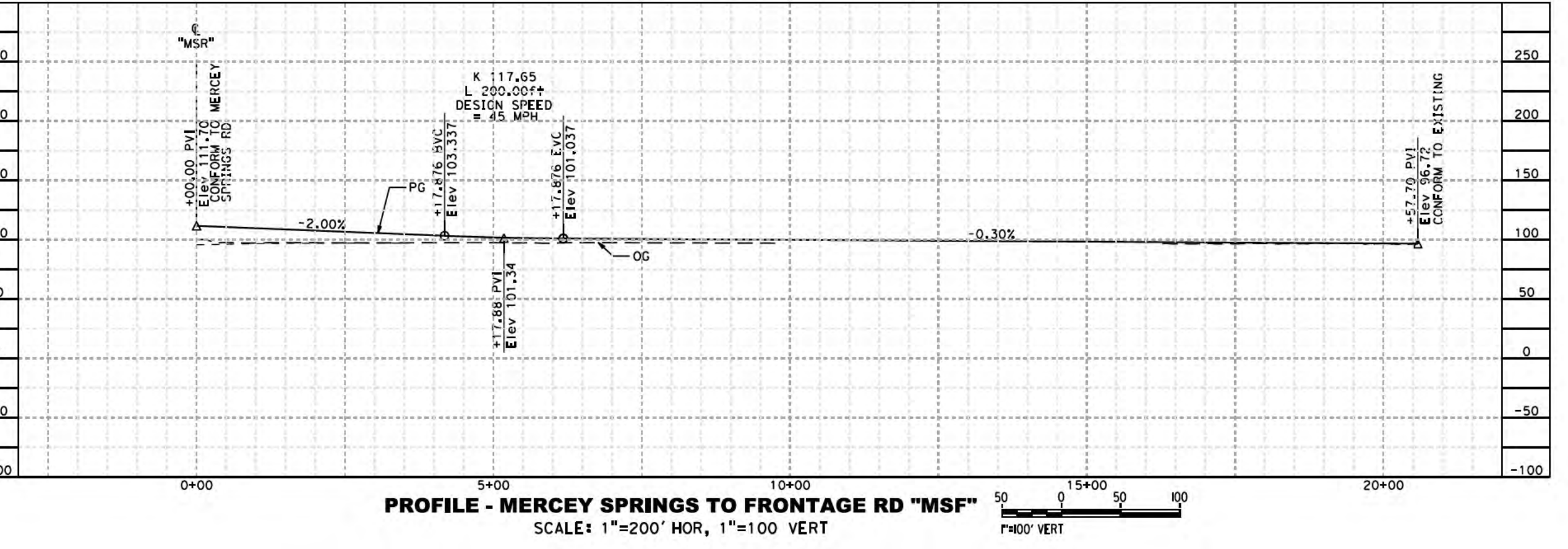
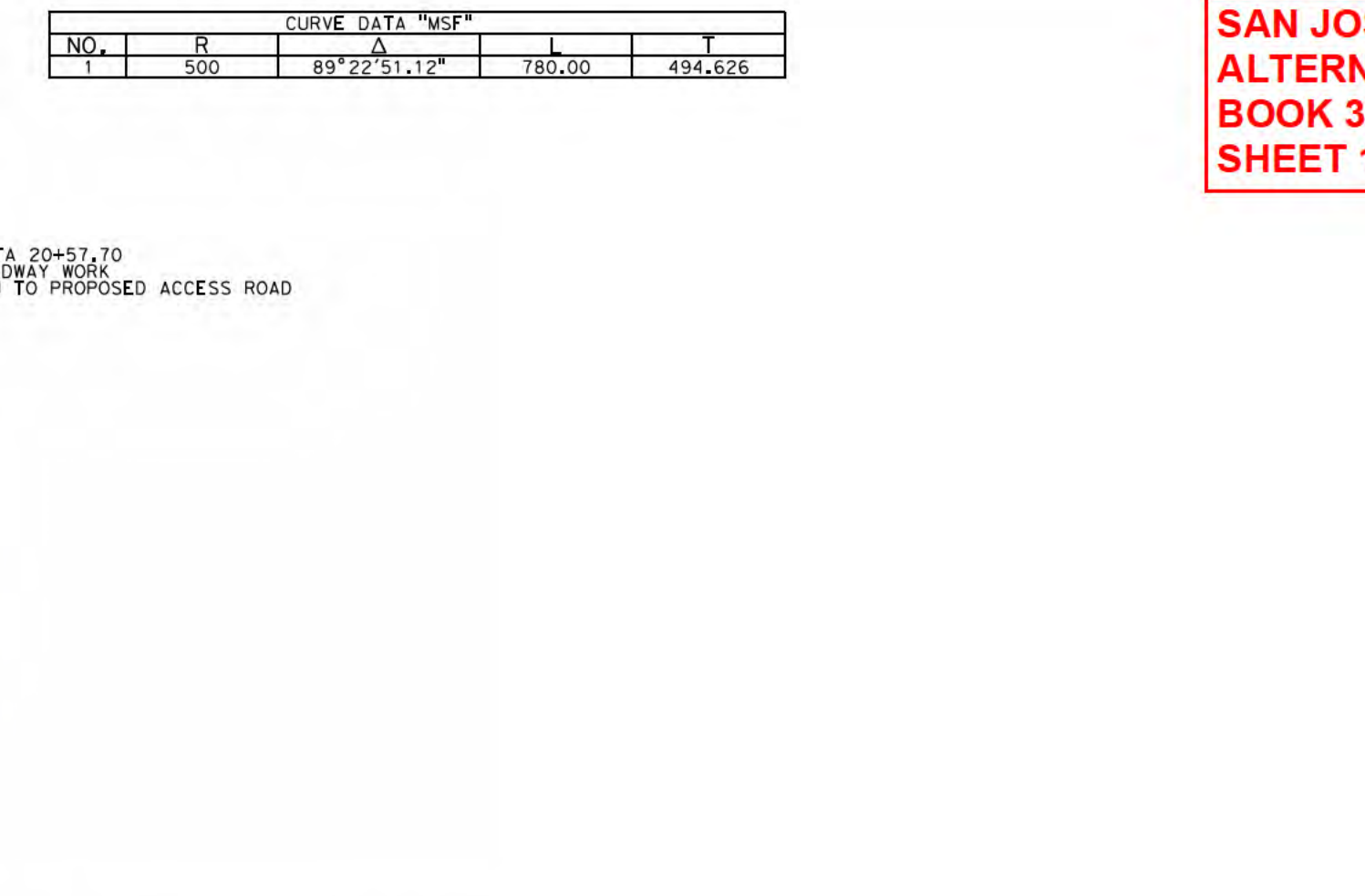
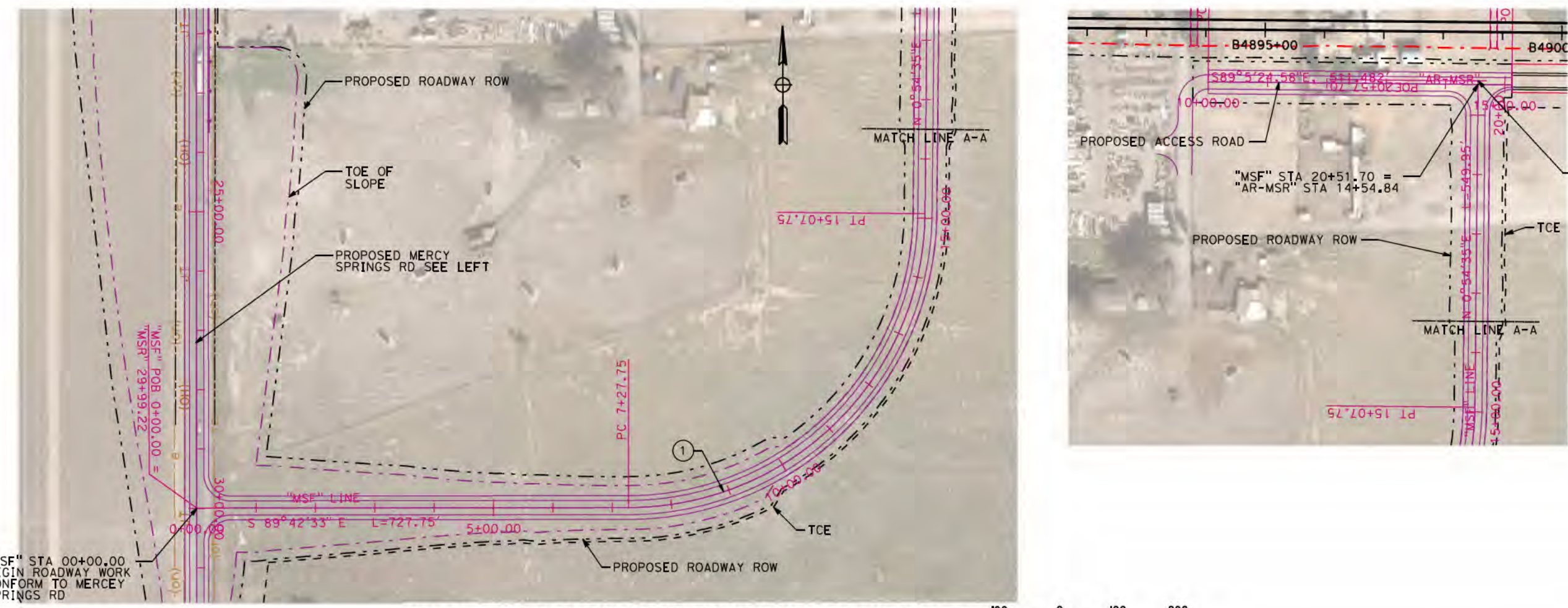
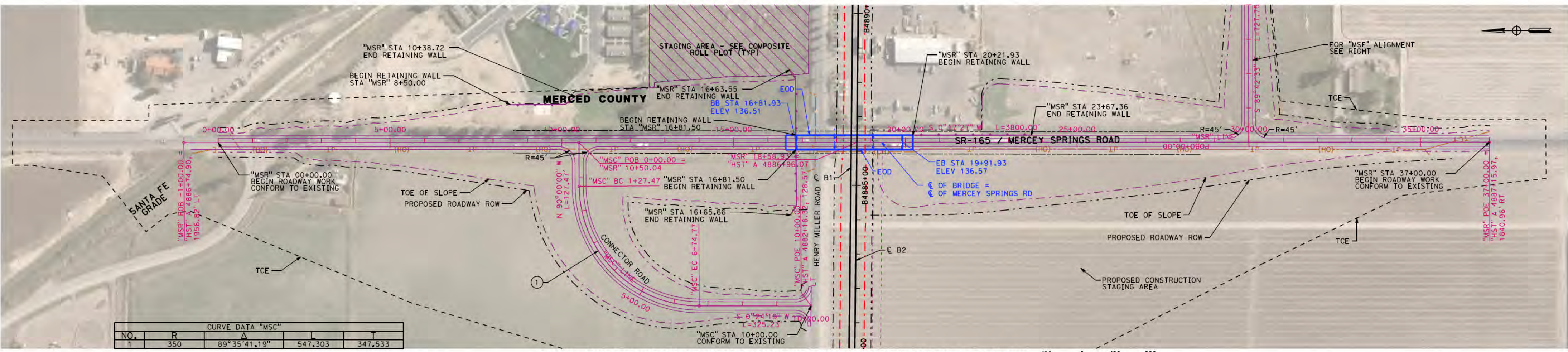

11/17/2025 09:58:28 AM C:\p\2025\1169\1169\_001.dwg 1169\_001.ctb 1169\_001.ctb 1169\_001.ctb

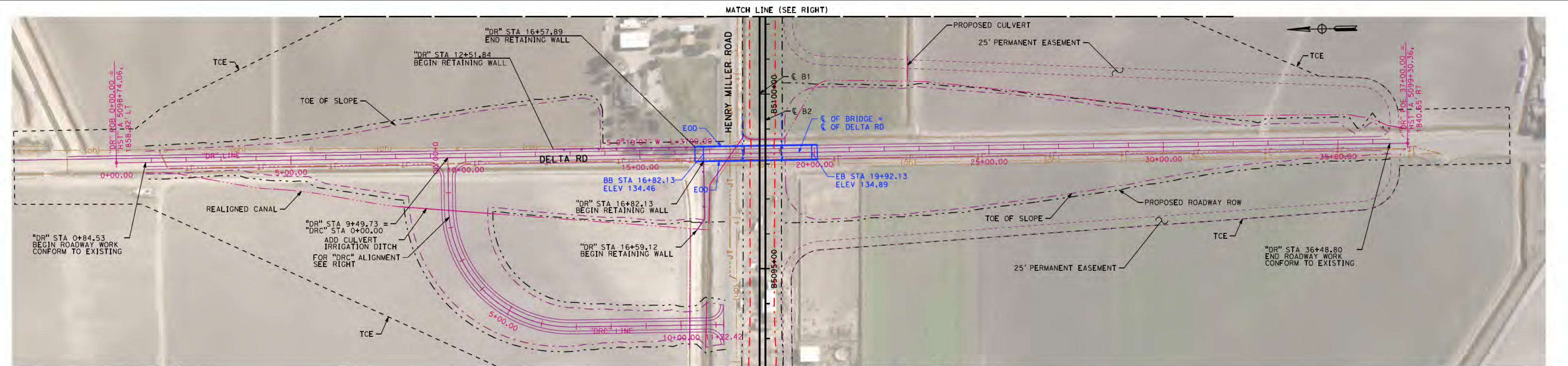

**PLAN - DELTA RD "DR"**  
 SCALE: 1"=200'

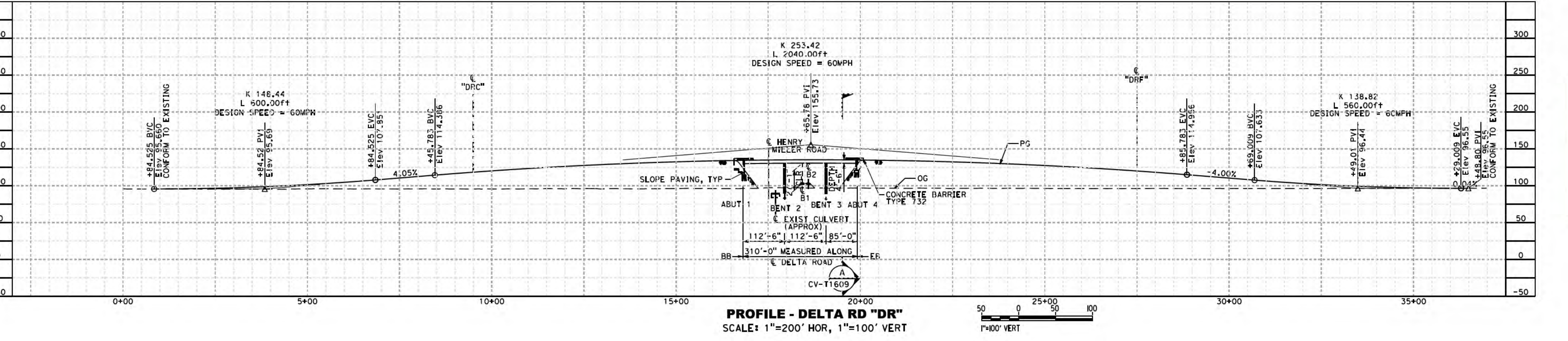

**PROFILE - DELTA RD "DR"**  
 SCALE: 1"=200' HOR, 1"=100' VERT

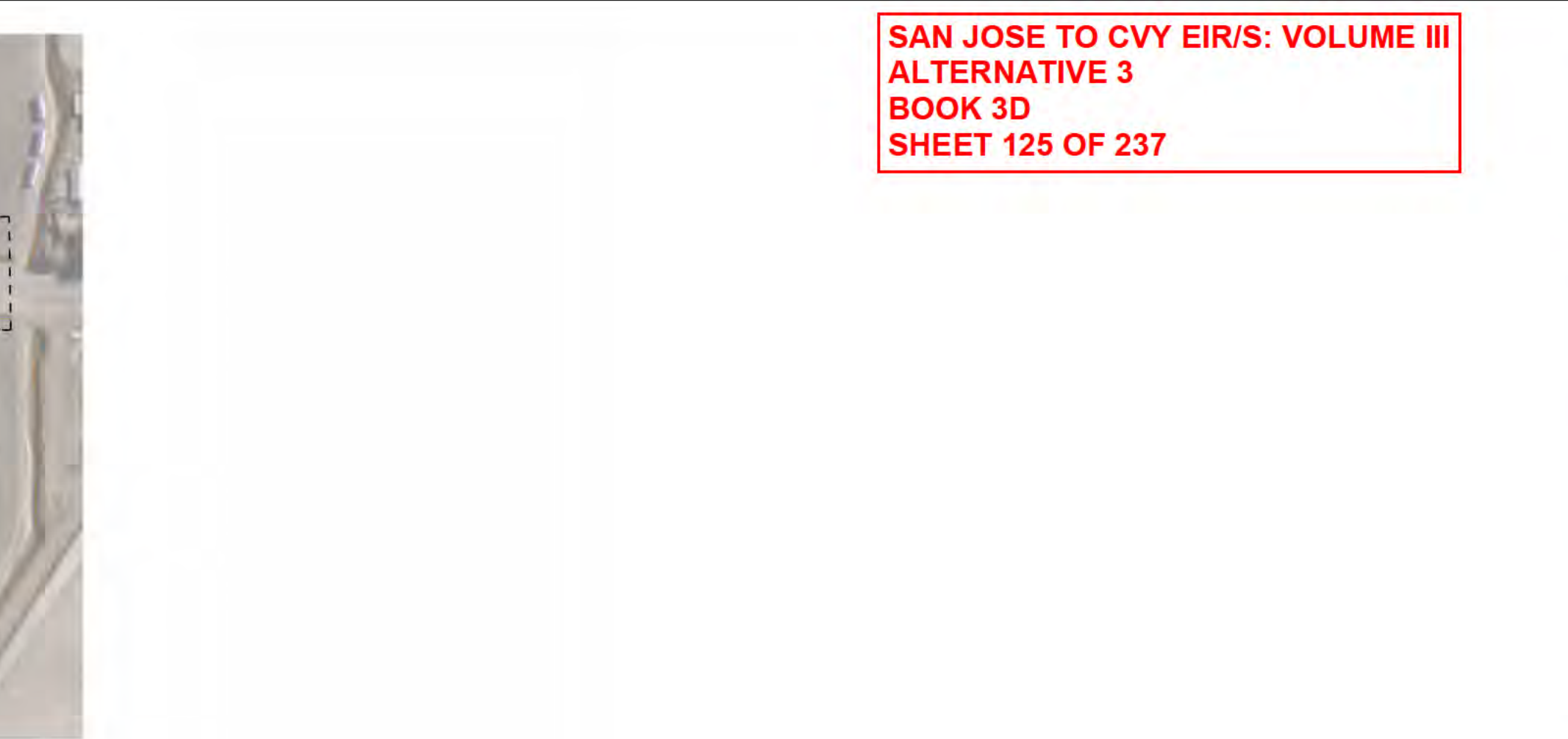

**PLAN - DELTA RD CONNECTOR "DRC"**  
 SCALE: 1"=200'

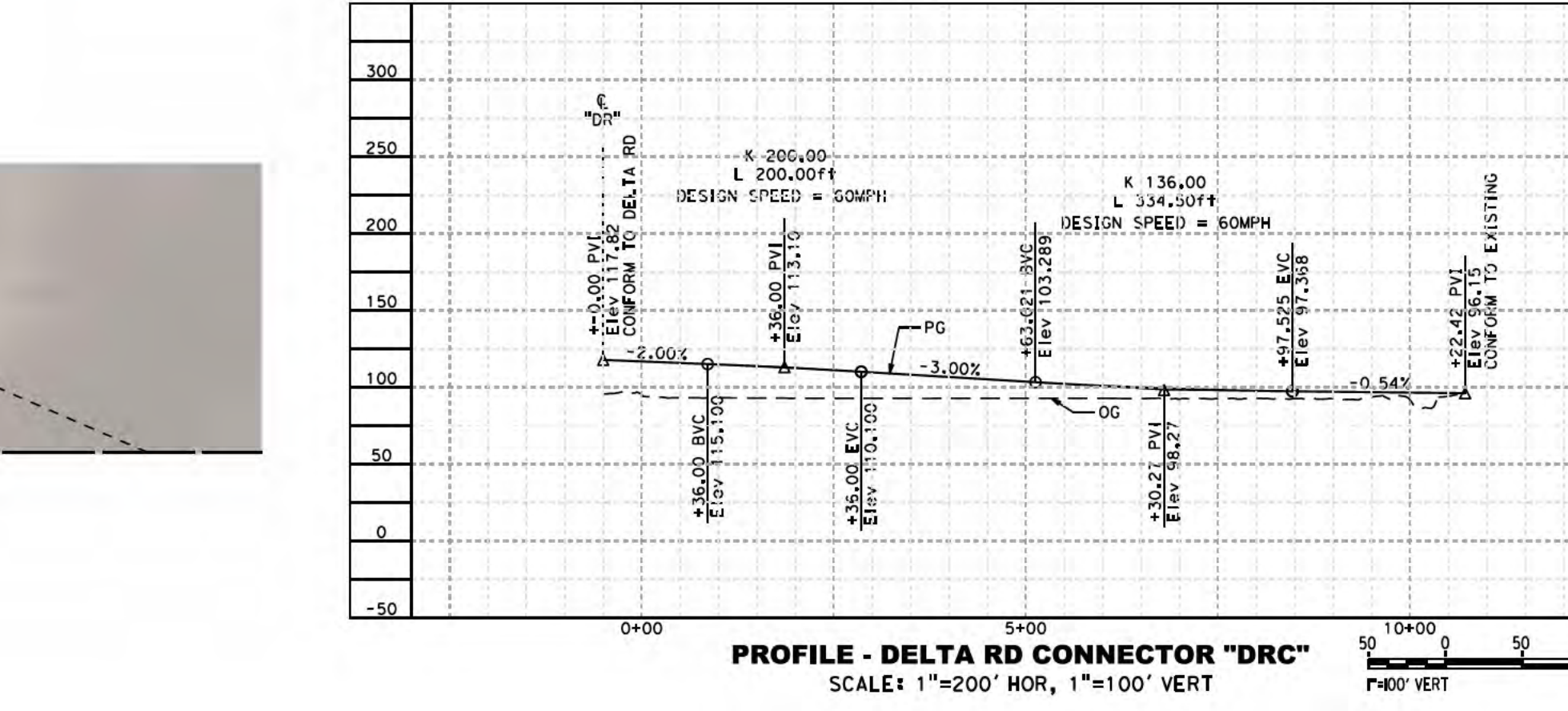

**PROFILE - DELTA RD CONNECTOR "DRC"**  
 SCALE: 1"=200' HOR, 1"=100' VERT

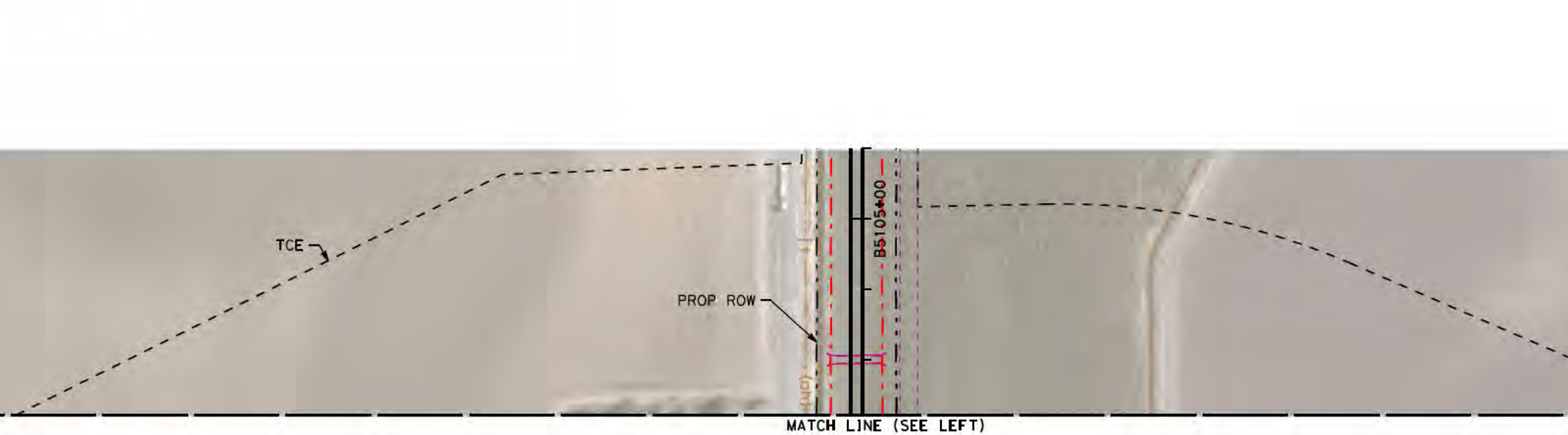

SAN JOSE TO CVY EIR/S: VOLUME III  
 ALTERNATIVE 3  
 BOOK 3D  
 SHEET 125 OF 237

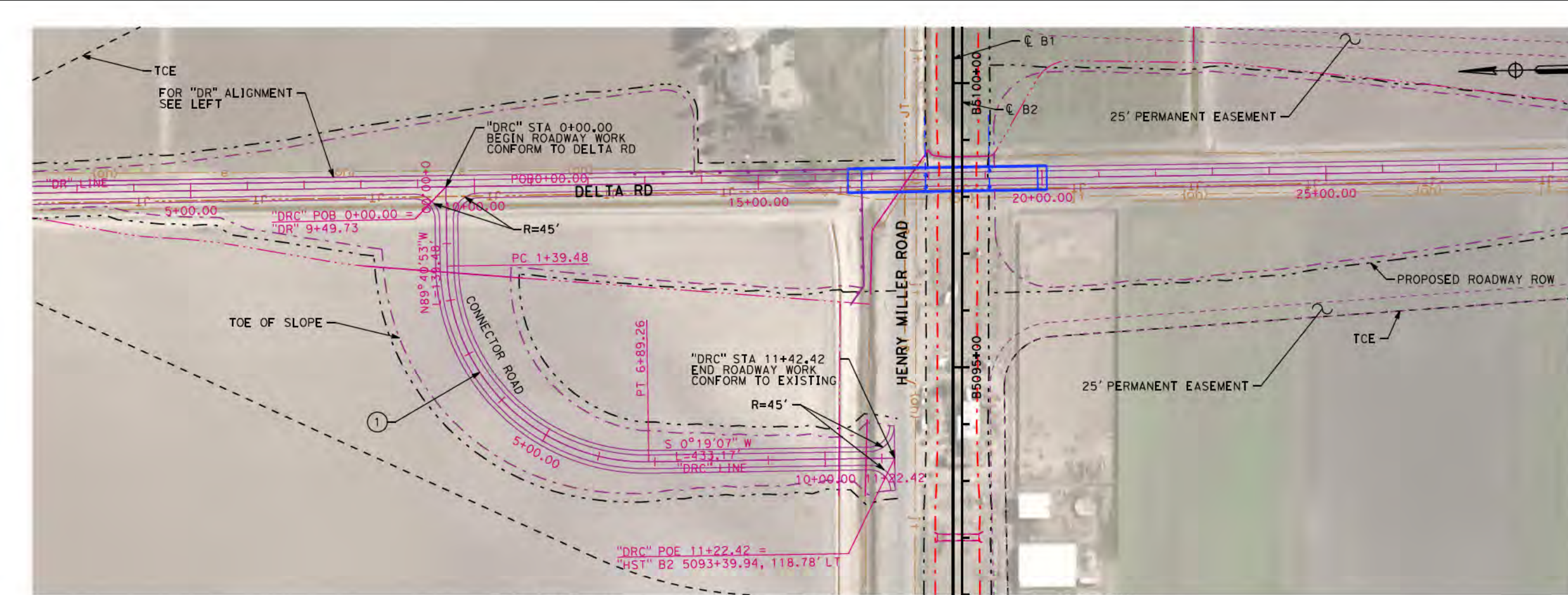

**PLAN - DELTA RD CONNECTOR "DRC"**  
 SCALE: 1"=200'

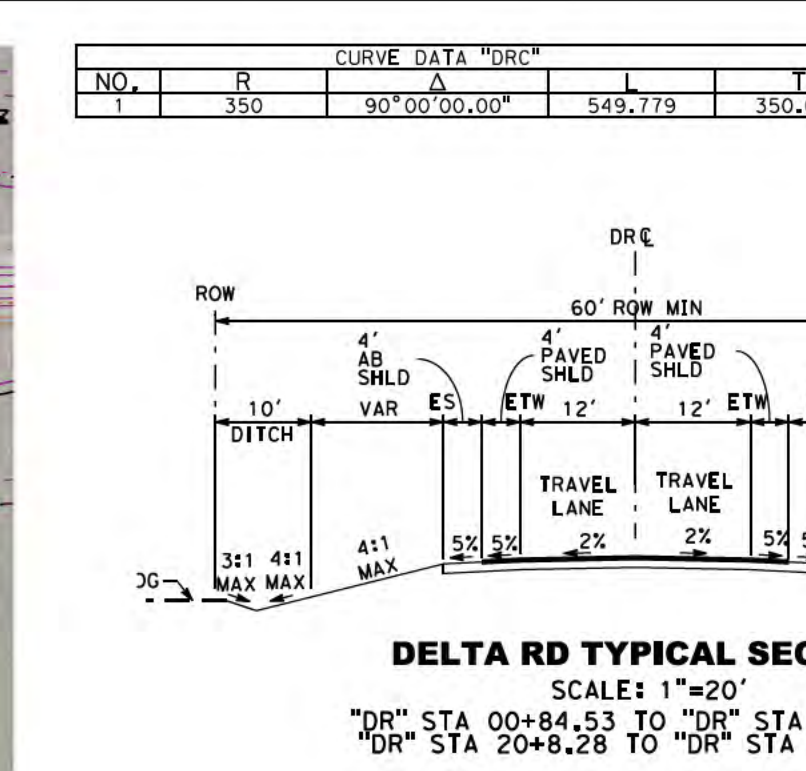

**DELTA RD TYPICAL SECTION**  
 SCALE: 1"=20'

"DR" STA 00+84.53 TO "DR" STA 13+82.15  
 "DR" STA 20+8.28 TO "DR" STA 36+48.80

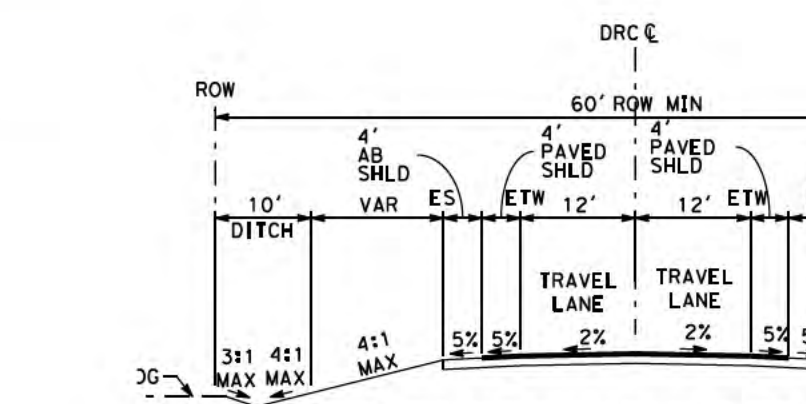

**DELTA RD TO HENRY MILLER RD CONNECTOR TYPICAL SECTION**  
 SCALE: 1"=20'

"DRC" STA 00+00.00 TO "DRC" STA 11+22.42

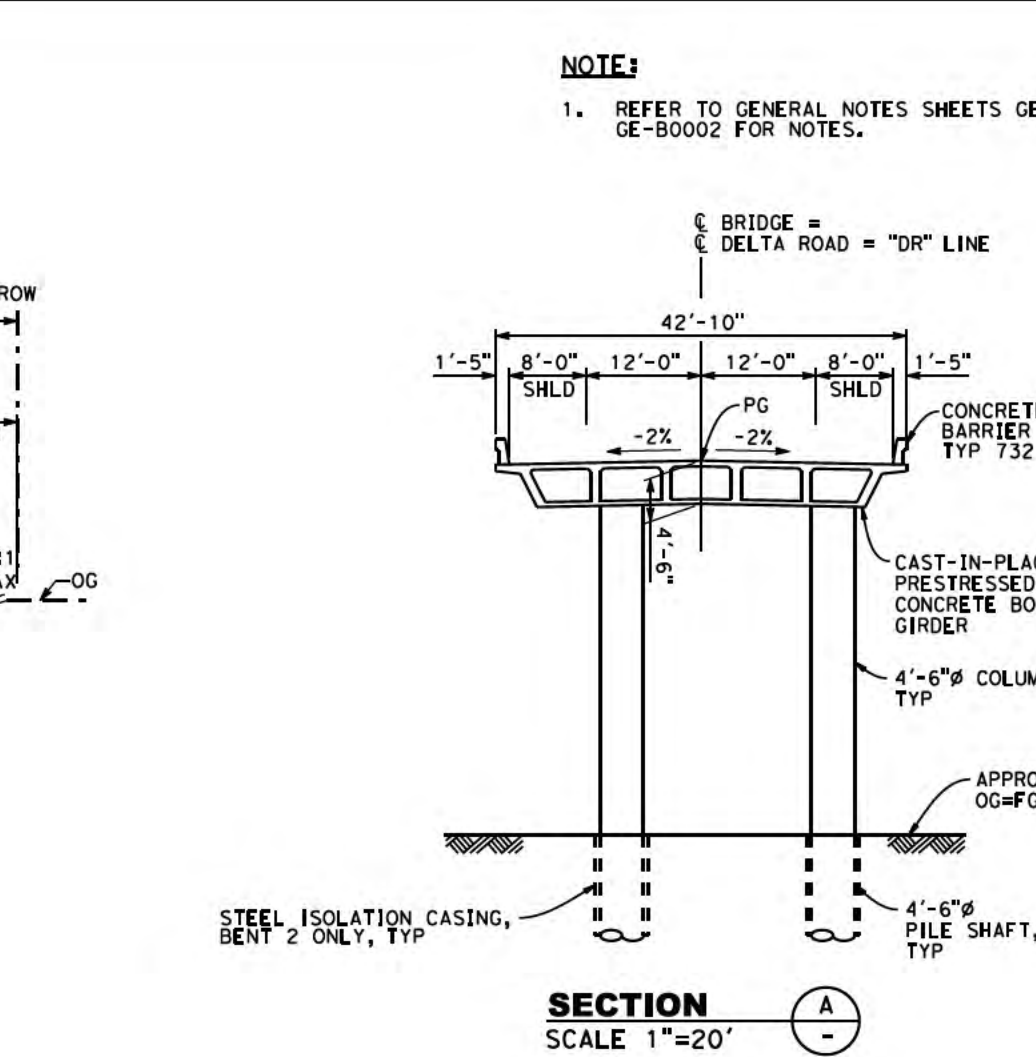

**NOTE:**  
 1. REFER TO GENERAL NOTES SHEETS GE-B0001 AND GE-B0002 FOR NOTES.

**SECTION A**  
 SCALE: 1"=20'

2021 RECORD SET PERD  
 NOVEMBER 30, 2021  
 NOT FOR CONSTRUCTION

**HNTB**  
 1111 Broadway  
 9th Floor  
 Oakland, CA 94607

**CALIFORNIA High-Speed Rail Authority**

**CALIFORNIA HIGH-SPEED TRAIN PROJECT**  
**SAN JOSE TO MERCED**  
 SAN JOAQUIN VALLEY  
 HENRY MILLER ROAD  
 GRADE SEPARATION LAYOUT, PROFILE, & CROSS SECTIONS  
 DELTA ROAD

CONTRACT NO. HSR15-34  
 DRAWING NO. CV-T1609  
 SCALE AS SHOWN  
 SHEET NO.

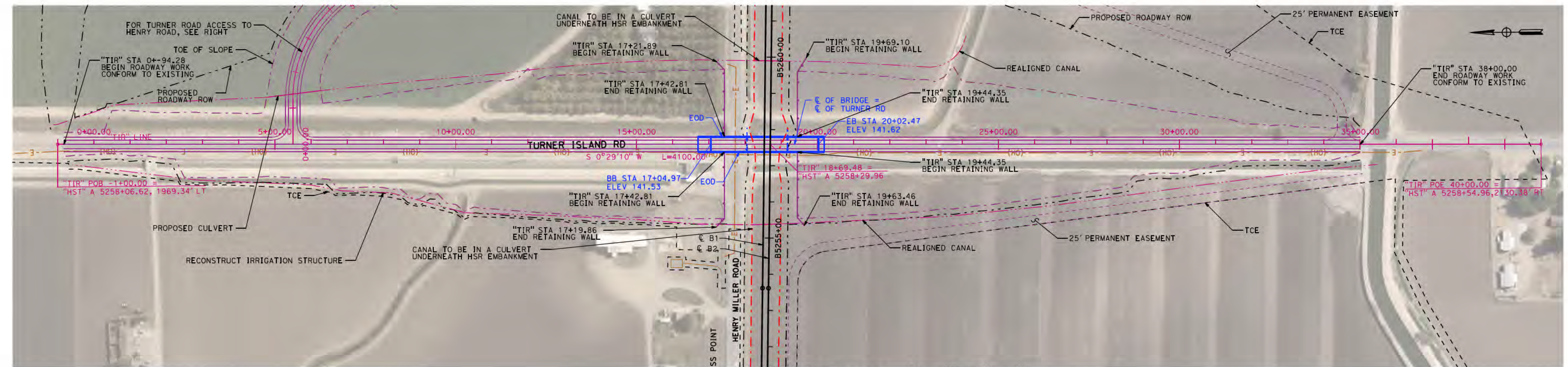

PLAN - TURNER ISLAND RD "TIR"  
SCALE: 1"=200'

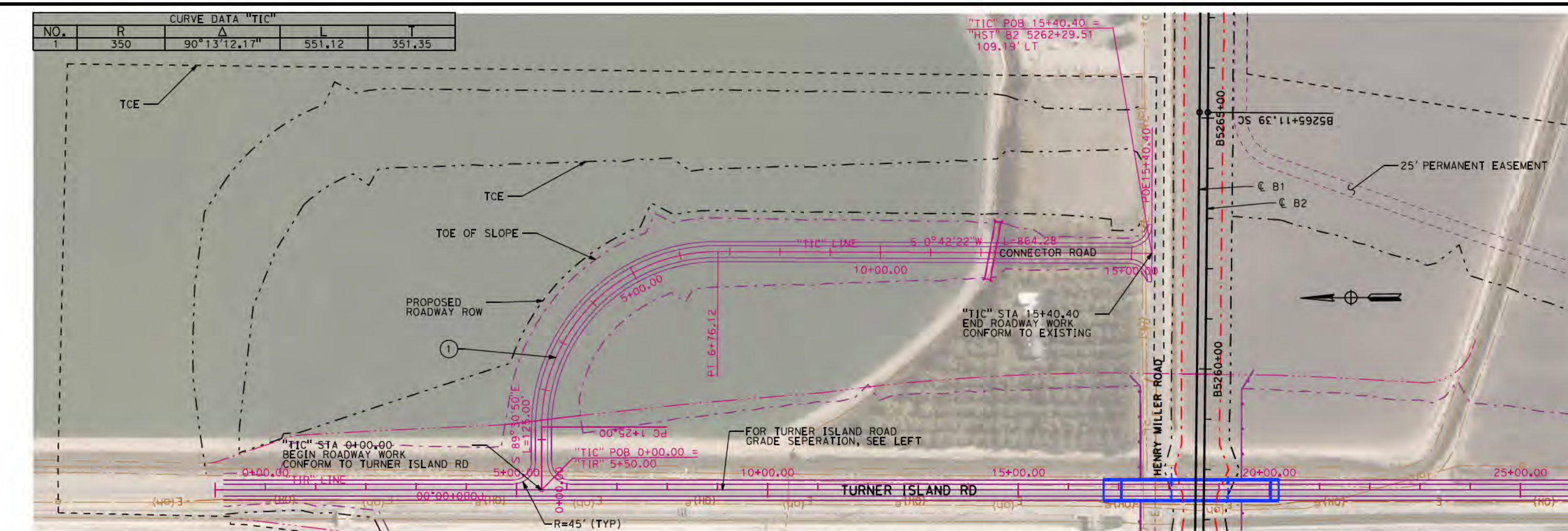

PLAN - TURNER ISLAND RD TO HENRY MILLER RD "TIC"  
SCALE: 1"=200'

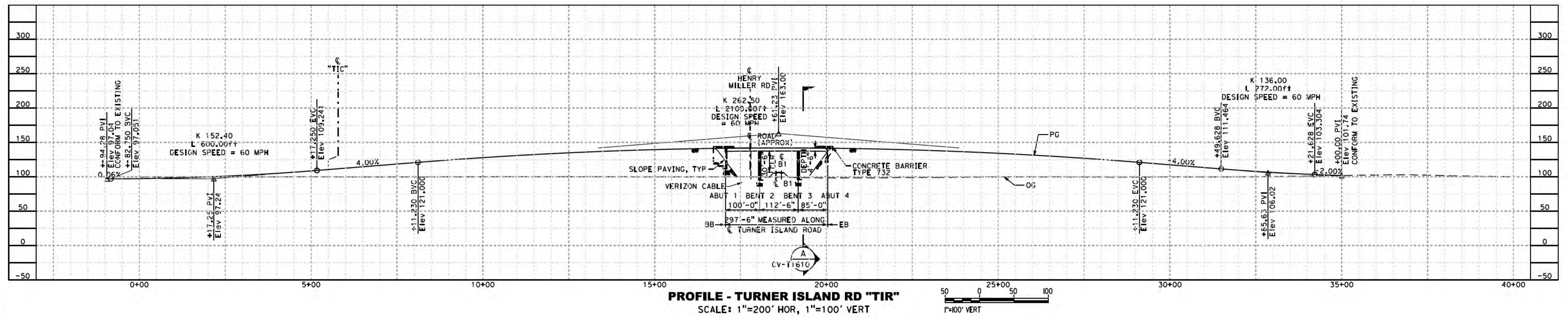

PROFILE - TURNER ISLAND RD "TIR"  
SCALE: 1"=200' HOR, 1"=100' VERT

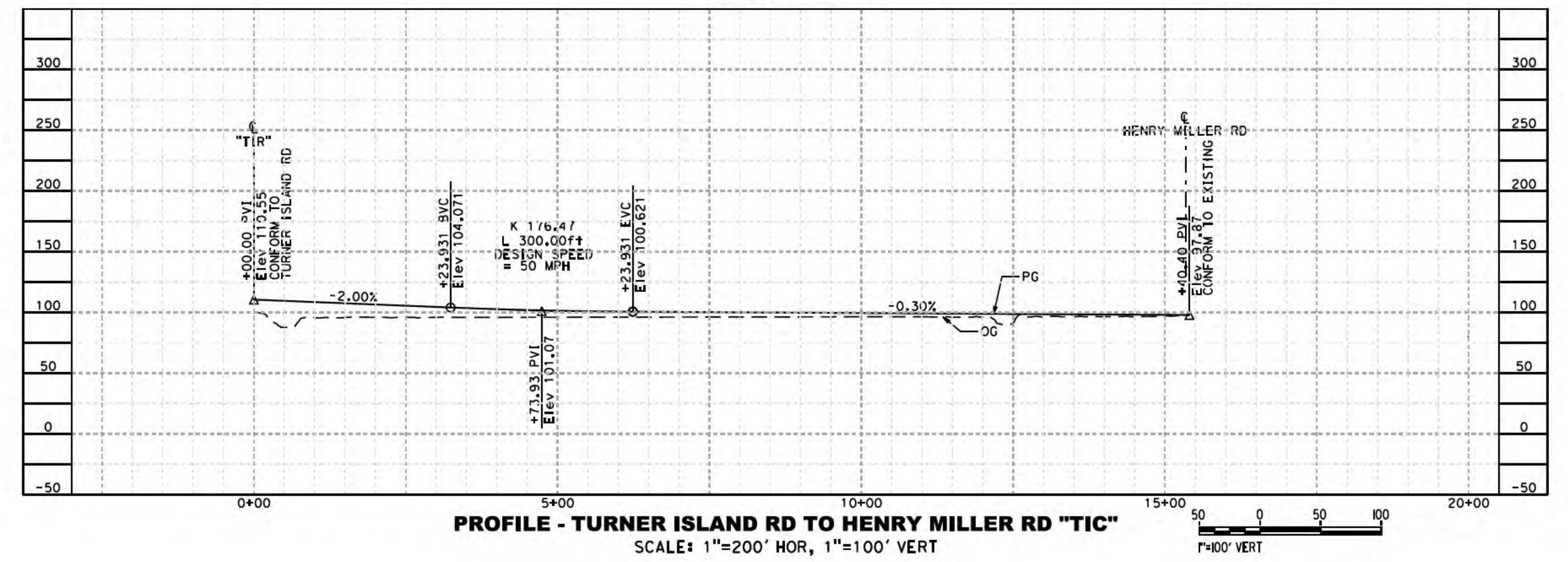

PROFILE - TURNER ISLAND RD TO HENRY MILLER RD "TIC"  
SCALE: 1"=200' HOR, 1"=100' VERT

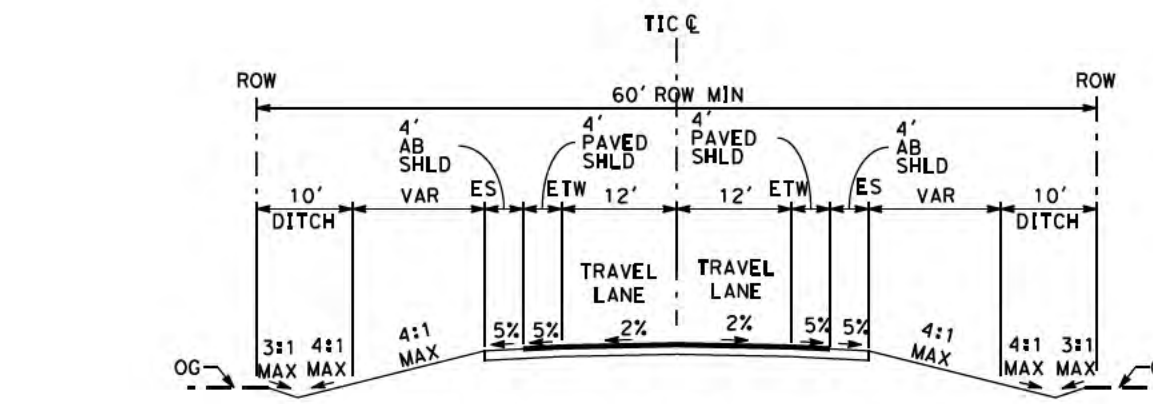

TURNER ISLAND RD TO HENRY MILLER RD  
TYPICAL SECTION  
SCALE: 1"=20'

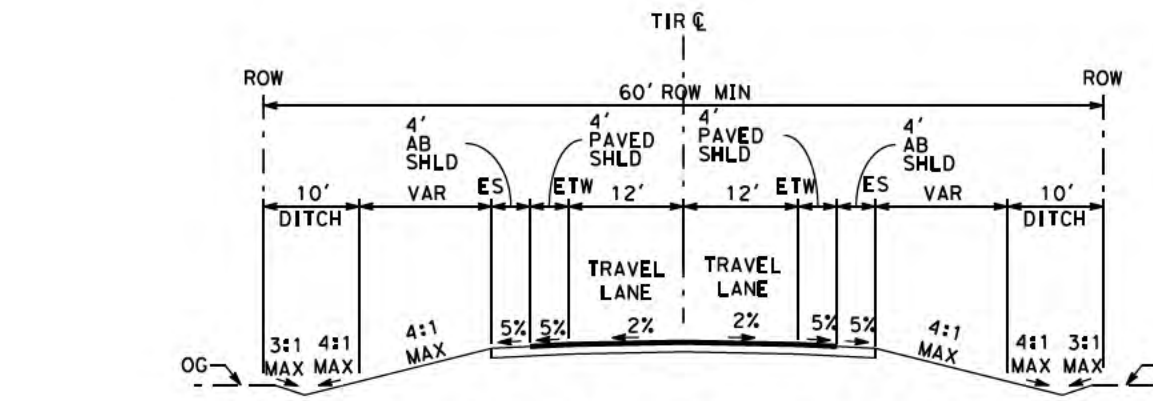

TURNER ISLAND RD TYPICAL SECTION  
SCALE: 1"=20'

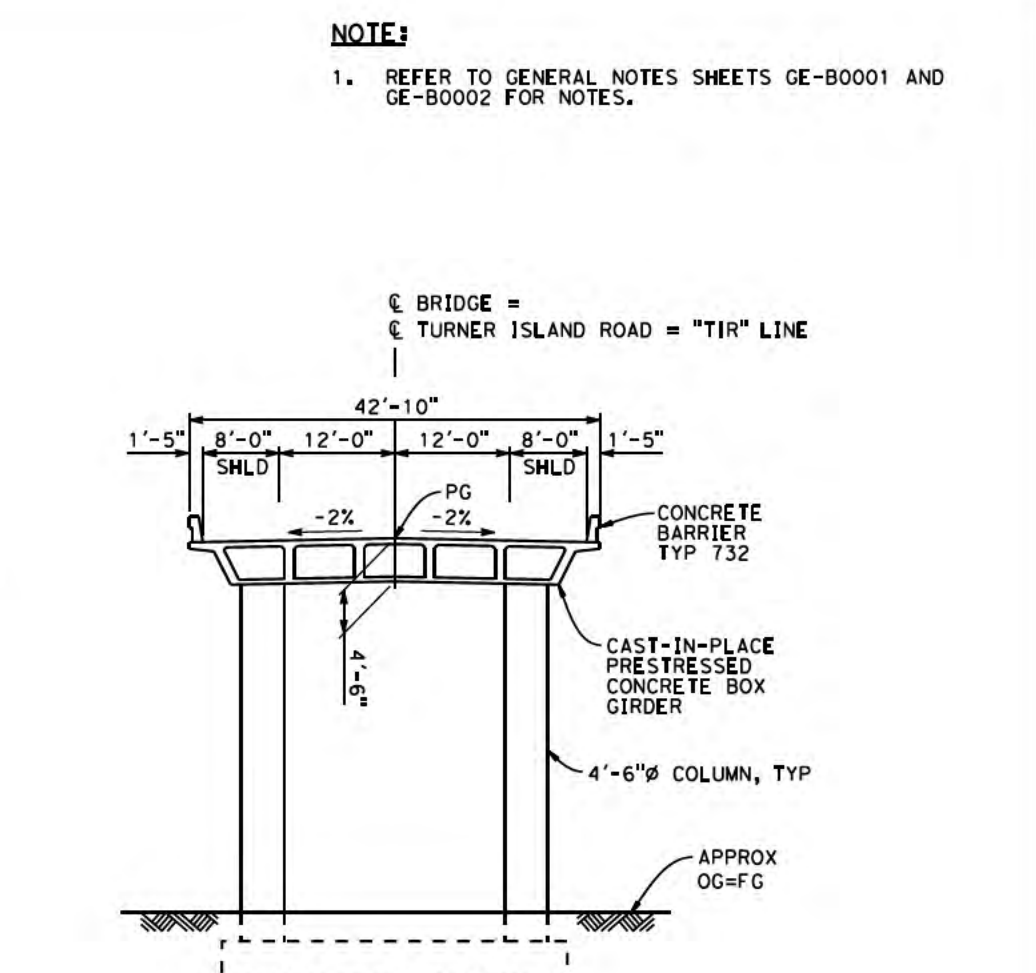

SECTION A  
SCALE 1"=20'

**SAN JOSE TO CVY EIR/S: VOLUME III**  
**ALTERNATIVE 3**  
**BOOK 3D**  
**SHEET 126 OF 237**

2021 RECORD SET PFD NOVEMBER 30, 2021 NOT FOR CONSTRUCTION		1111 Broadway 9th Floor Oakland, CA 94607		<b>CALIFORNIA HIGH-SPEED TRAIN PROJECT</b> <b>SAN JOSE TO MERCED</b> HENRY MILLER ROAD GRADE SEPARATION LAYOUT, PROFILE, & CROSS SECTIONS TURNER ROAD	CONTRACT NO. HSR15-34 DRAWING NO. CV-T1610 SCALE AS SHOWN SHEET NO.
--	--	---	--	---	--

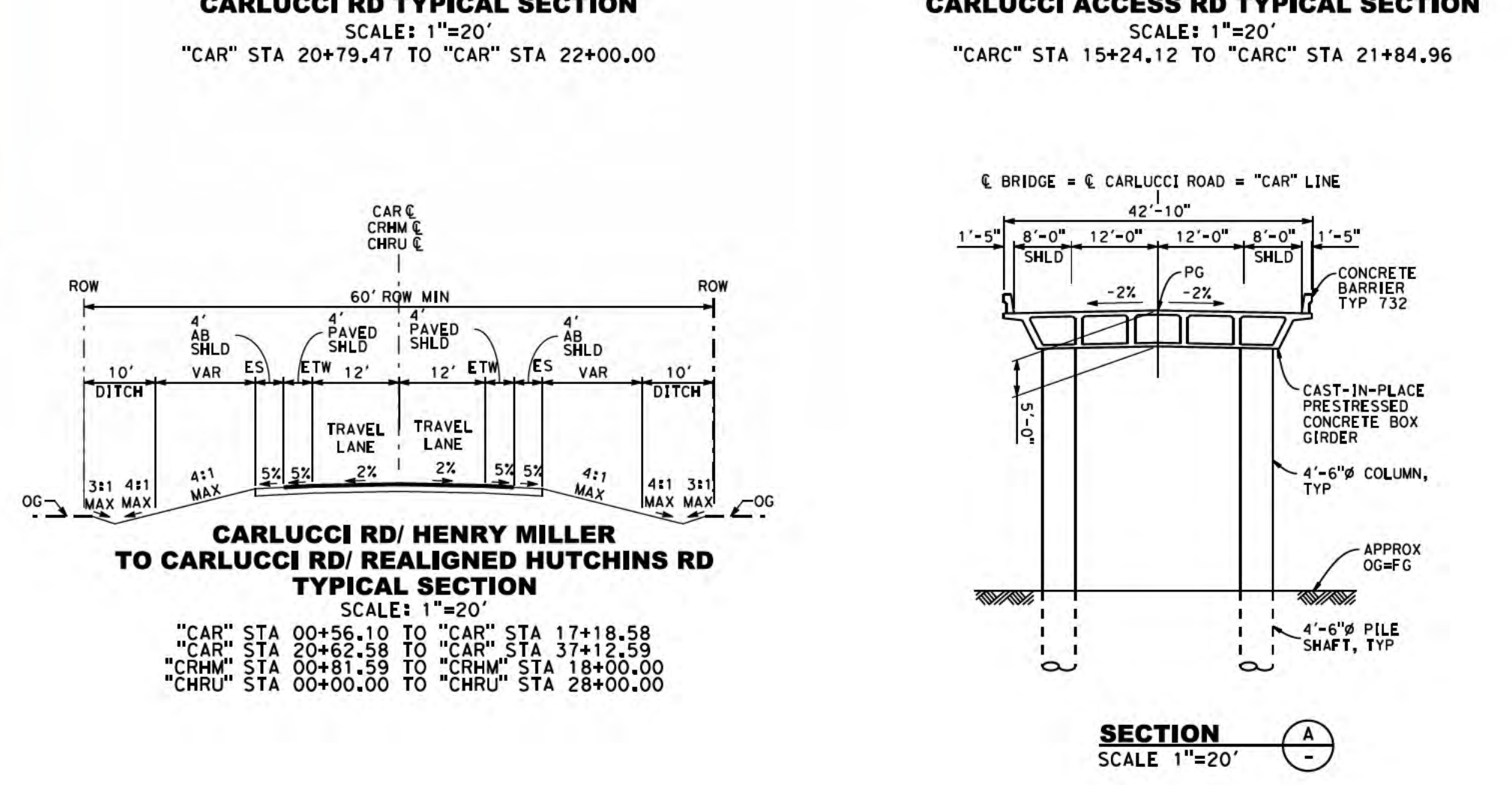
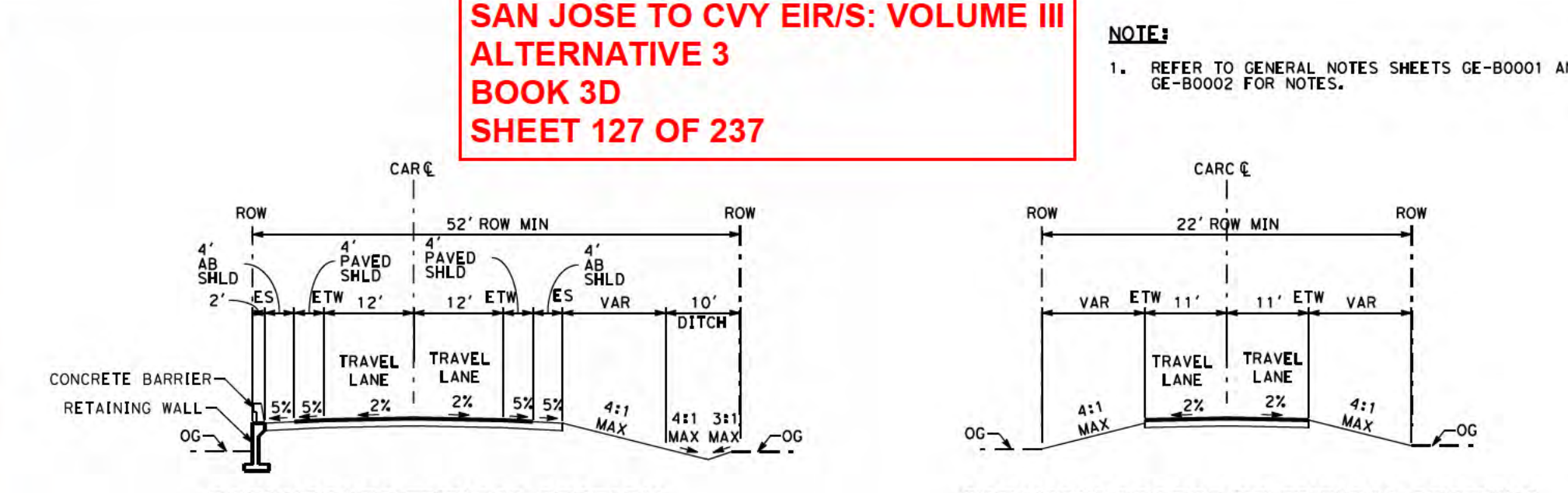
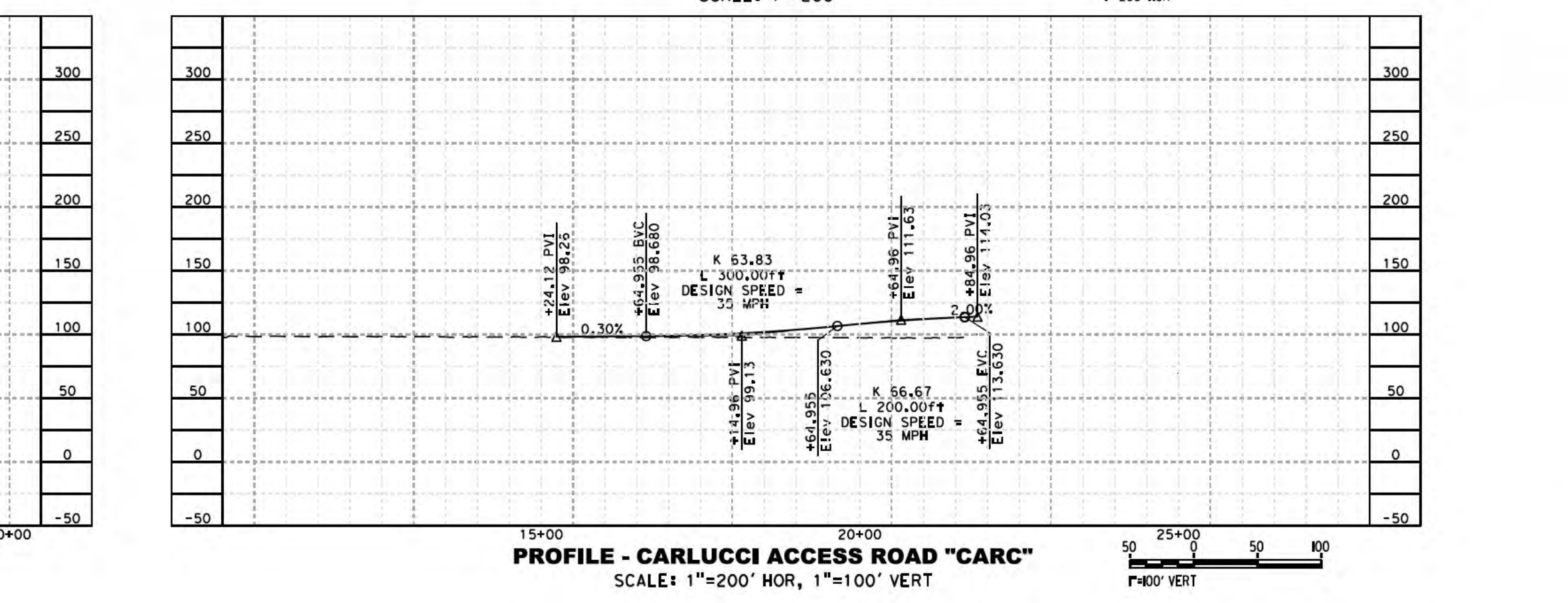
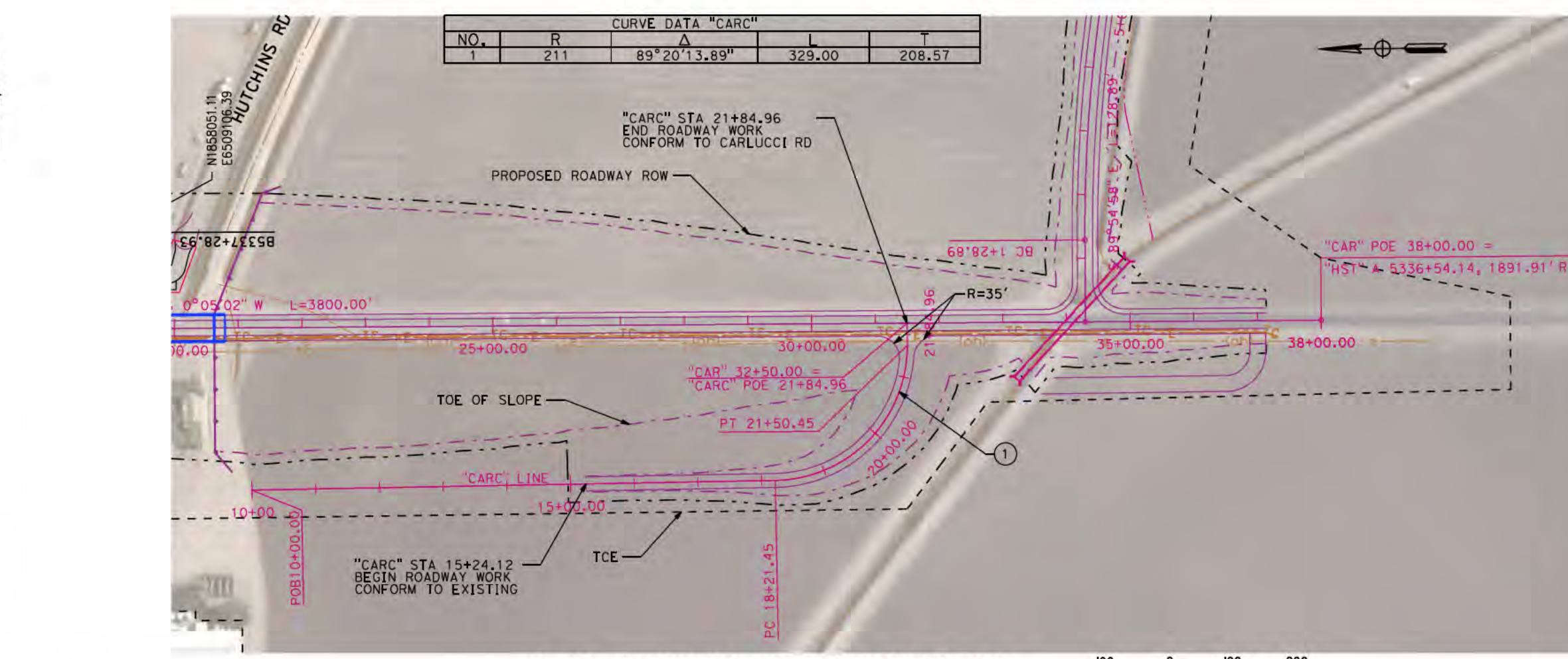
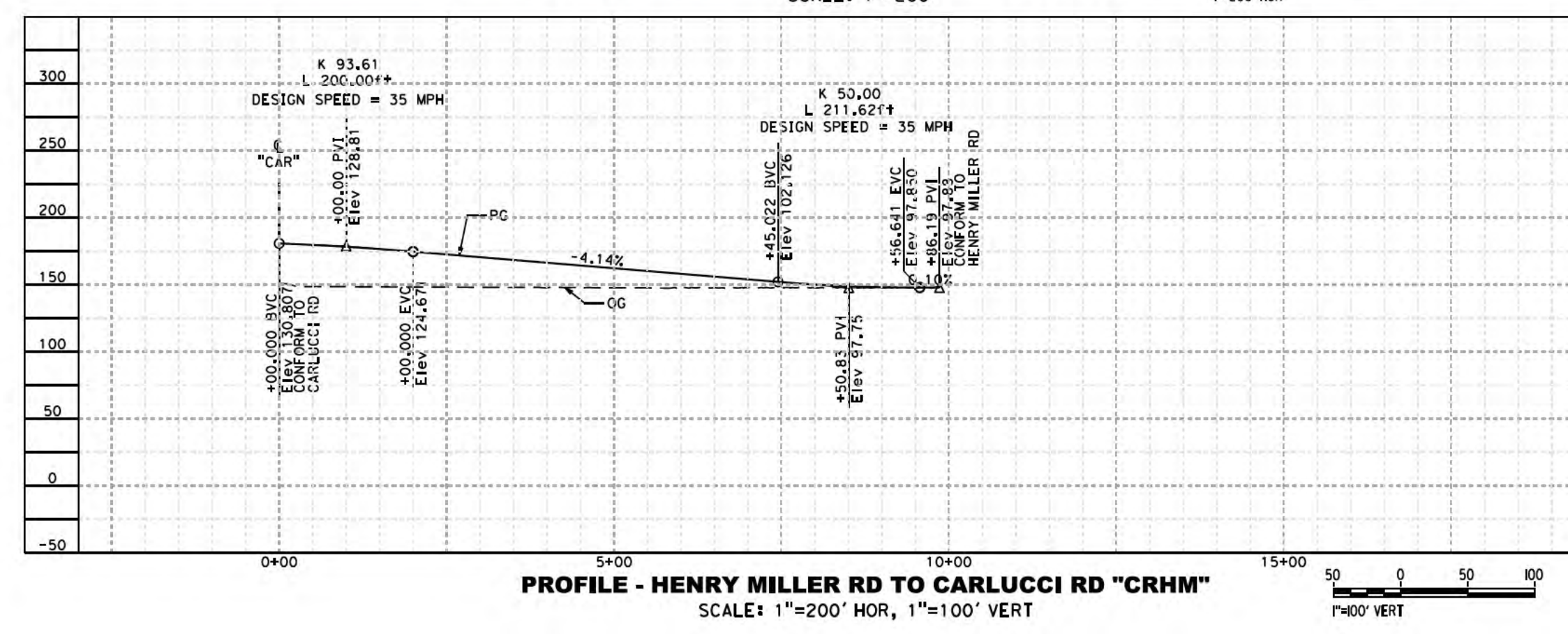
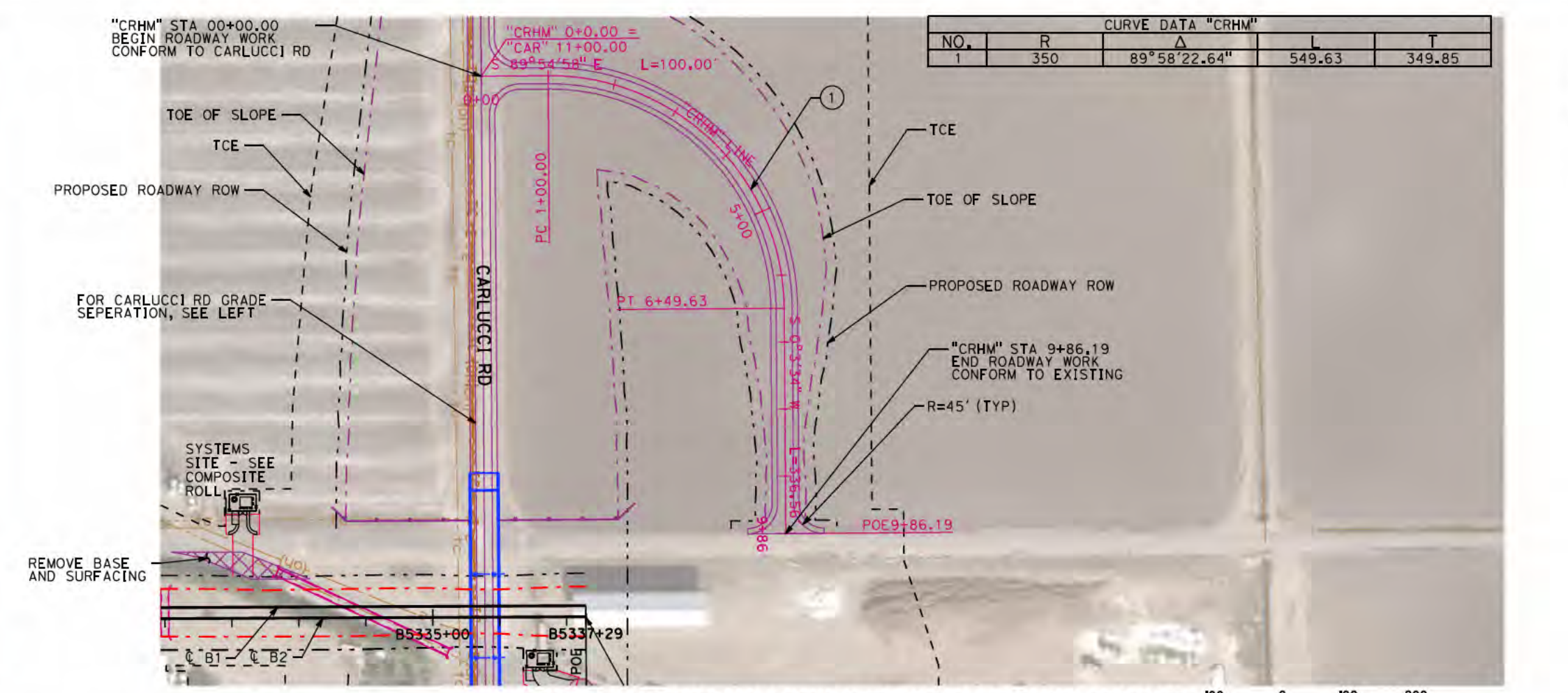
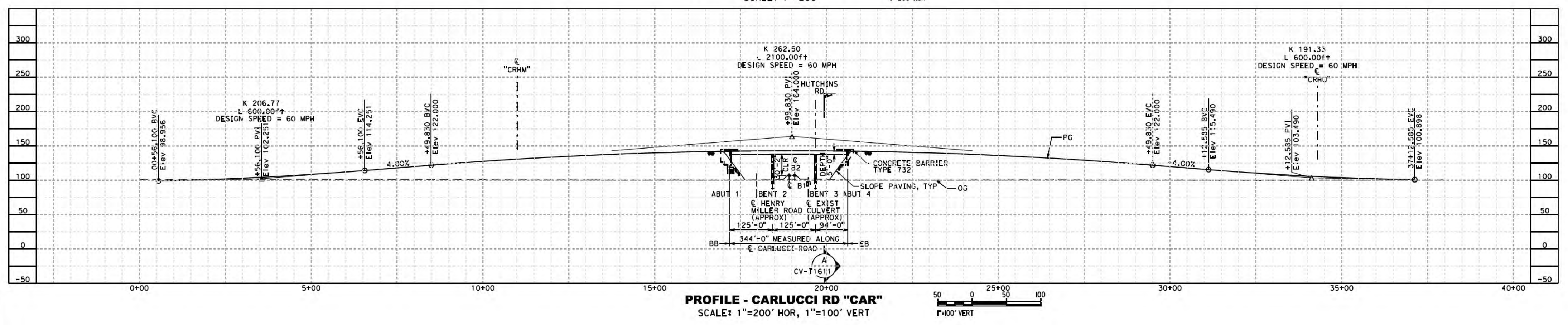
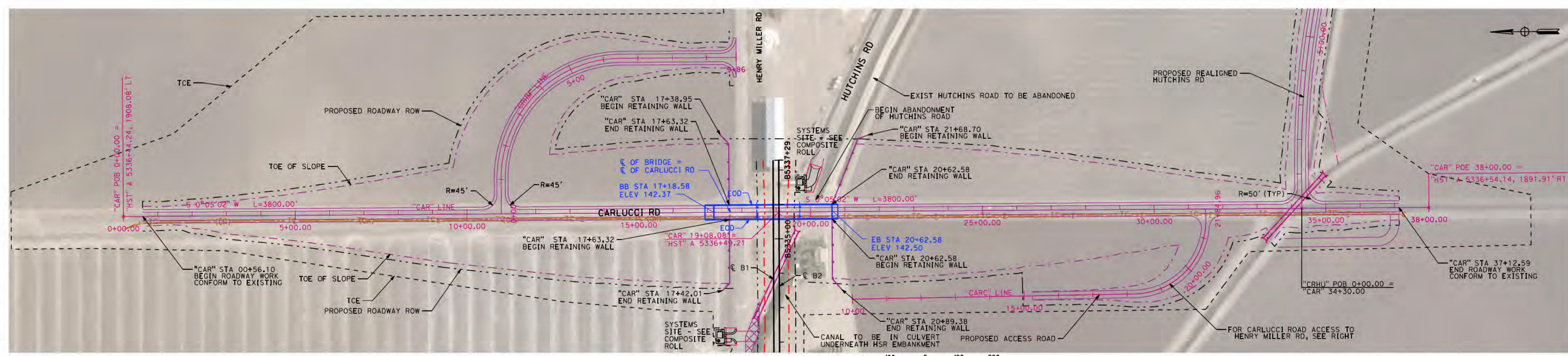

2021 RECORD SET PPD  
NOVEMBER 30, 2021  
NOT FOR CONSTRUCTION

1111 Broadway  
9th Floor  
Oakland, CA 94607

**CALIFORNIA**  
High-Speed Rail Authority

**CALIFORNIA HIGH-SPEED TRAIN PROJECT**  
SAN JOSE TO MERCED  
HENRY MILLER ROAD  
GRADE SEPARATION LAYOUT, PROFILE, & CROSS SECTIONS  
CARLUCCI ROAD

CONTRACT NO. HSR15-34  
DRAWING NO. CV-T1611  
SCALE AS SHOWN  
SHEET NO.

**SAN JOSE TO CVY EIR/S: VOLUME III**  
**ALTERNATIVE 3**  
**BOOK 3D**  
**SHEET 127 OF 237**

**NOTE:**  
1. REFER TO GENERAL NOTES SHEETS GE-B0001 AND GE-B0002 FOR NOTES.

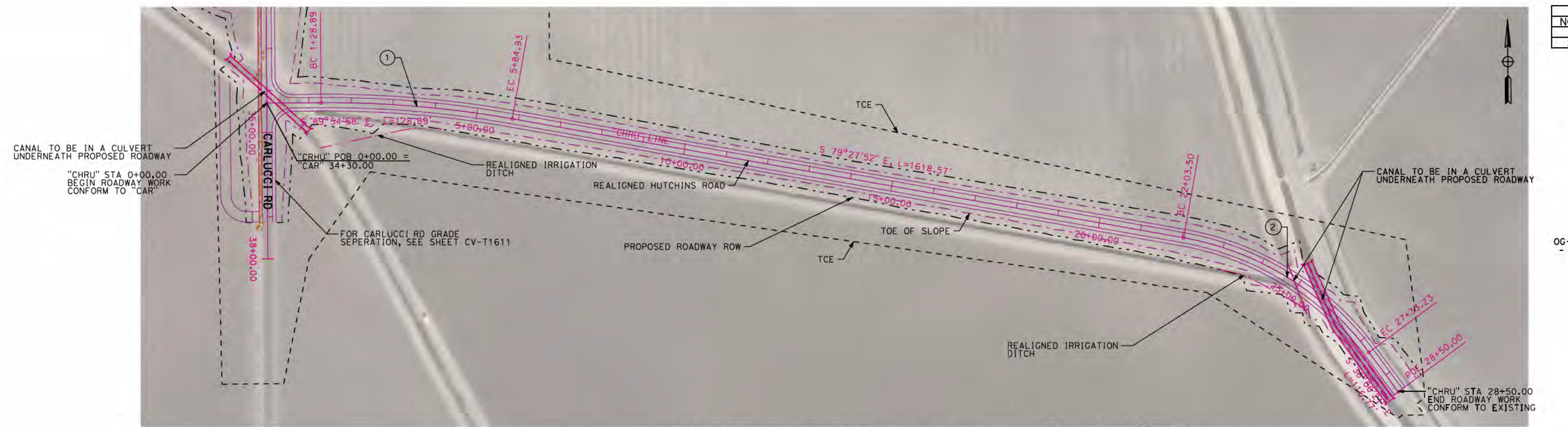

**PLAN - REALIGNED HUTCHINS ROAD "CHRU"**  
SCALE: 1"=200'

CURVE DATA "CHRU"				
NO.	R	A	T	Y
1	2500	10°27'05.95"	456.039	228.654
2	700	43°21'31.47"	529.727	278.272

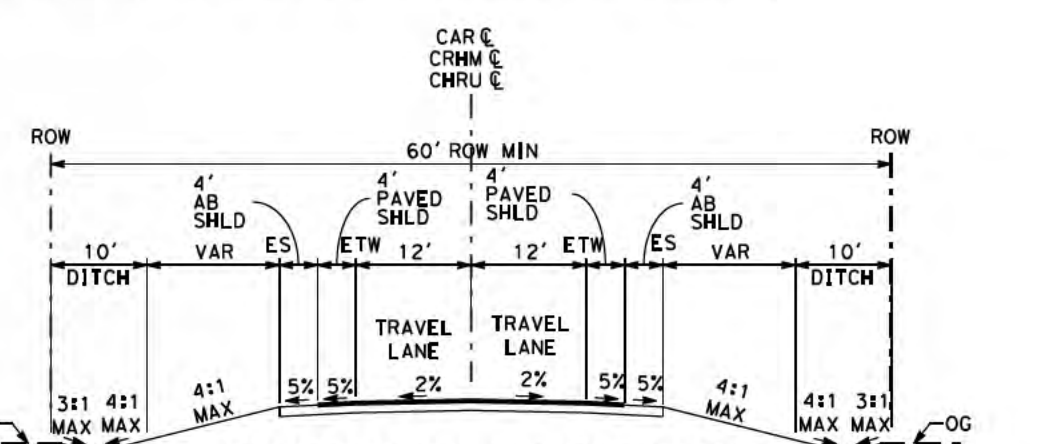

**CARLUCCI RD/ HENRY MILLER TO CARLUCCI RD/ REALIGNED HUTCHINS RD**  
**TYPICAL SECTION**  
SCALE: 1"=20'

"CAR" STA 00+56.10 TO "CAR" STA 17+18.58  
 "CAR" STA 20+62.58 TO "CAR" STA 37+12.59  
 "CRHM" STA 00+81.59 TO "CRHM" STA 18+00.00  
 "CHRU" STA 00+00.00 TO "CHRU" STA 28+00.00

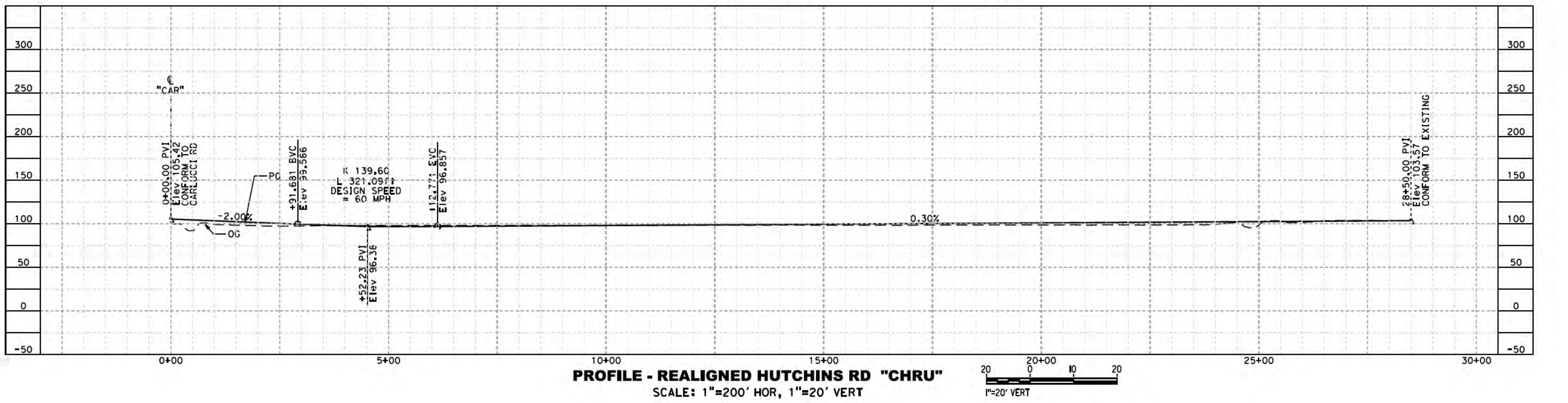

**PROFILE - REALIGNED HUTCHINS RD "CHRU"**  
SCALE: 1"=200' HOR, 1"=20' VERT

**NOTE:**  
1. REFER TO GENERAL NOTES SHEETS GE-B0001 AND GE-B0002 FOR NOTES.

**SAN JOSE TO CVY EIR/S: VOLUME III**  
**ALTERNATIVE 3**  
**BOOK 3D**  
**SHEET 128 OF 237**

2021 RECORD SET PBD NOVEMBER 30, 2021 NOT FOR CONSTRUCTION	<b>HNTB</b> 1111 Broadway 9th Floor Oakland, CA 94607		<b>CALIFORNIA HIGH-SPEED TRAIN PROJECT</b> <b>SAN JOSE TO MERCED</b> SAN JOAQUIN VALLEY HENRY MILLER ROAD GRADE SEPARATION LAYOUT, PROFILE, & CROSS SECTIONS HUTCHINS ROAD	CONTRACT NO. HSR15-34 DRAWING NO. CV-T1612 SCALE AS SHOWN SHEET NO.
--	--	--	---	--

11/22/2021 10:56:16 AM C:\proj\_2\p11\110000.dwg 11/22/2021 10:56:16 AM C:\proj\_2\p11\110000.dwg



**SAN JOSE TO CVY EIR/S: VOLUME III**  
**ALTERNATIVE 3**  
**BOOK 3D**  
**SHEET 129 OF 237**

**PLAN**  
 SCALE: 1"=200'



2021 RECORD SET P&ID NOVEMBER 30, 2021 NOT FOR CONSTRUCTION	1111 Broadway 9th Floor Oakland, CA 94607		<b>CALIFORNIA HIGH-SPEED TRAIN PROJECT</b> <b>SAN JOSE TO MERCED</b> MORGAN HILL AND GILROY VIADUCT TO DOWNTOWN GILROY MAINTENANCE OF WAY FACILITY DETAIL PLAN	CONTRACT NO. HSR15-34 DRAWING NO. MT-B0906 SCALE AS SHOWN SHEET NO.
---	---	--	---	--

10/29/2021 11:54 AM C:\Users\h1\OneDrive\Documents\2021\San Jose to Merced\Book 3D\130 of 237.dwg



**SAN JOSE TO CVY EIR/S: VOLUME III**  
**ALTERNATIVE 3**  
**BOOK 3D**  
**SHEET 130 OF 237**

2021 RECORD SET PBD NOVEMBER 30, 2021 NOT FOR CONSTRUCTION		1111 Broadway 9th Floor Oakland, CA 94607		<b>CALIFORNIA HIGH-SPEED TRAIN PROJECT</b> <b>SAN JOSE TO MERCED</b> VIADUCT TO DOWNTOWN GILROY MAINTENANCE OF WAY FACILITY TYPICAL SECTIONS	CONTRACT NO. HSR15-34 DRAWING NO. M7-B0907 SCALE AS SHOWN SHEET NO.
--	--	---	--	--	---





11/30/2021 12:55:56 AM C:\p02\2021\125556.dwg CALHSR101 civi\port\_20211130.ctb C:\Users\mrb\OneDrive\Documents\1130.ctb

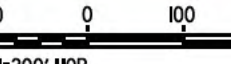


**SAN JOSE TO CVY EIR/S: VOLUME III**  
**ALTERNATIVE 3**  
**BOOK 3D**  
**SHEET 132 OF 237**

2021 RECORD  
 SET PBD  
 NOVEMBER 30, 2021  
 NOT FOR  
 CONSTRUCTION



1111 Broadway  
 9th Floor  
 Oakland, CA 94607



**CALIFORNIA HIGH-SPEED TRAIN PROJECT**  
**SAN JOSE TO MERCED**  
 MORGAN HILL AND GILROY  
 VIADUCT TO EAST GILROY  
 MAINTENANCE OF WAY FACILITY  
 DETAIL PLAN

CONTRACT NO. HSR15-34  
 DRAWING NO. MY-B1106  
 SCALE AS SHOWN  
 SHEET NO.

10/29/2021 4:53:37 PM C:\Users\hnl\OneDrive\Documents\hntb\10292021\San Jose to Merced\Drawings\MT-B1107.dwg



SECTION A  
SCALE 1"=10'-0"

SECTION C  
SCALE 1"=10'-0"

SECTION B  
SCALE 1"=10'-0"

**SAN JOSE TO CVY EIR/S: VOLUME III  
ALTERNATIVE 3  
BOOK 3D  
SHEET 133 OF 237**

2021 RECORD SET PBD NOVEMBER 30, 2021 NOT FOR CONSTRUCTION	<b>HNTB</b> 1111 Broadway 9th Floor Oakland, CA 94607	<b>CALIFORNIA</b> High-Speed Rail Authority	<b>CALIFORNIA HIGH-SPEED TRAIN PROJECT</b> SAN JOSE TO MERCED VIADUCT TO EAST GILROY MAINTENANCE OF WAY FACILITY TYPICAL SECTIONS	CONTRACT NO. HSR15-34 DRAWING NO. MT-B1107 SCALE AS SHOWN SHEET NO.
--	--	--	---	---



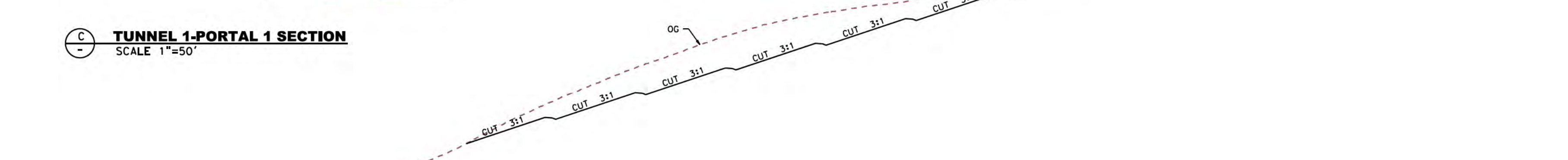
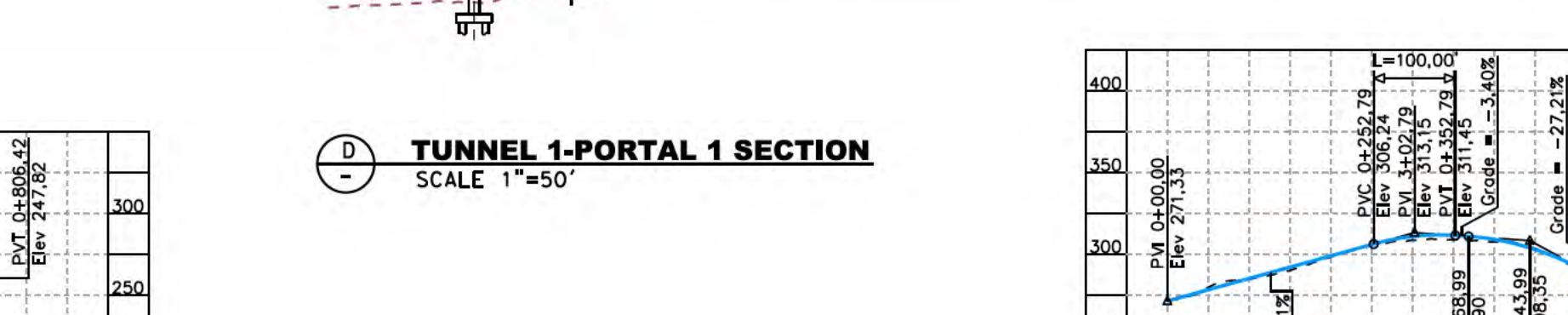
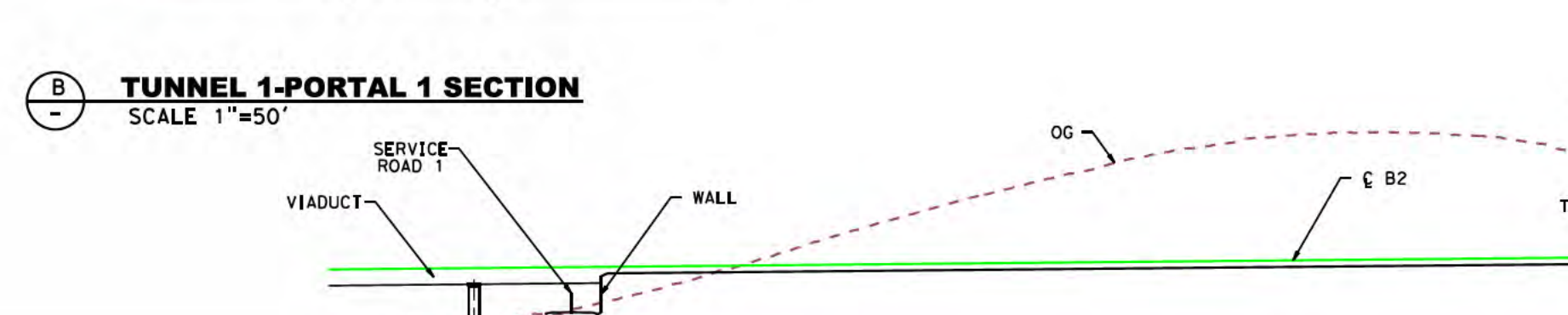
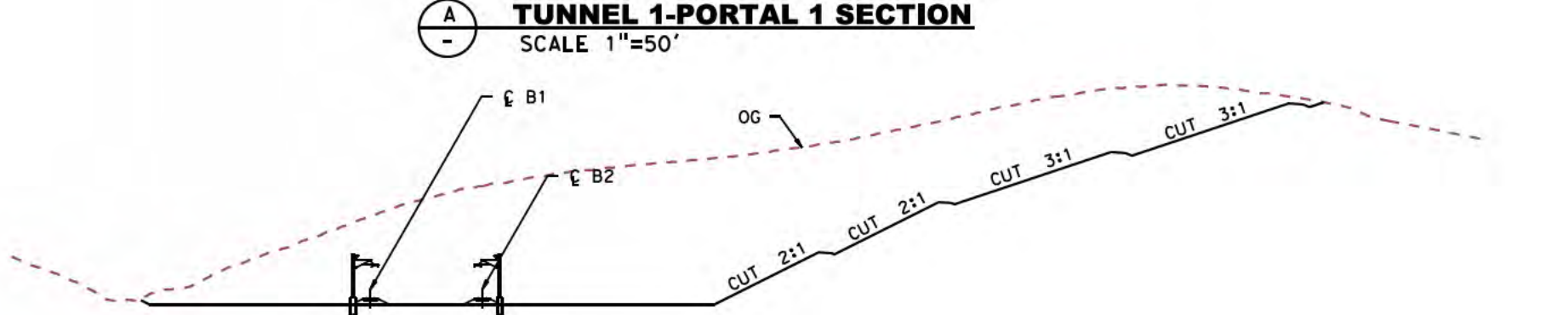
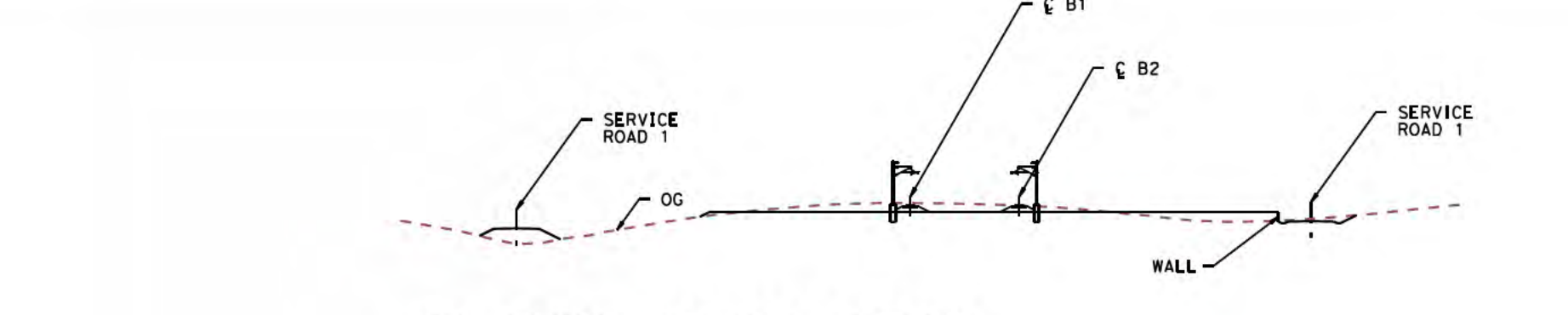
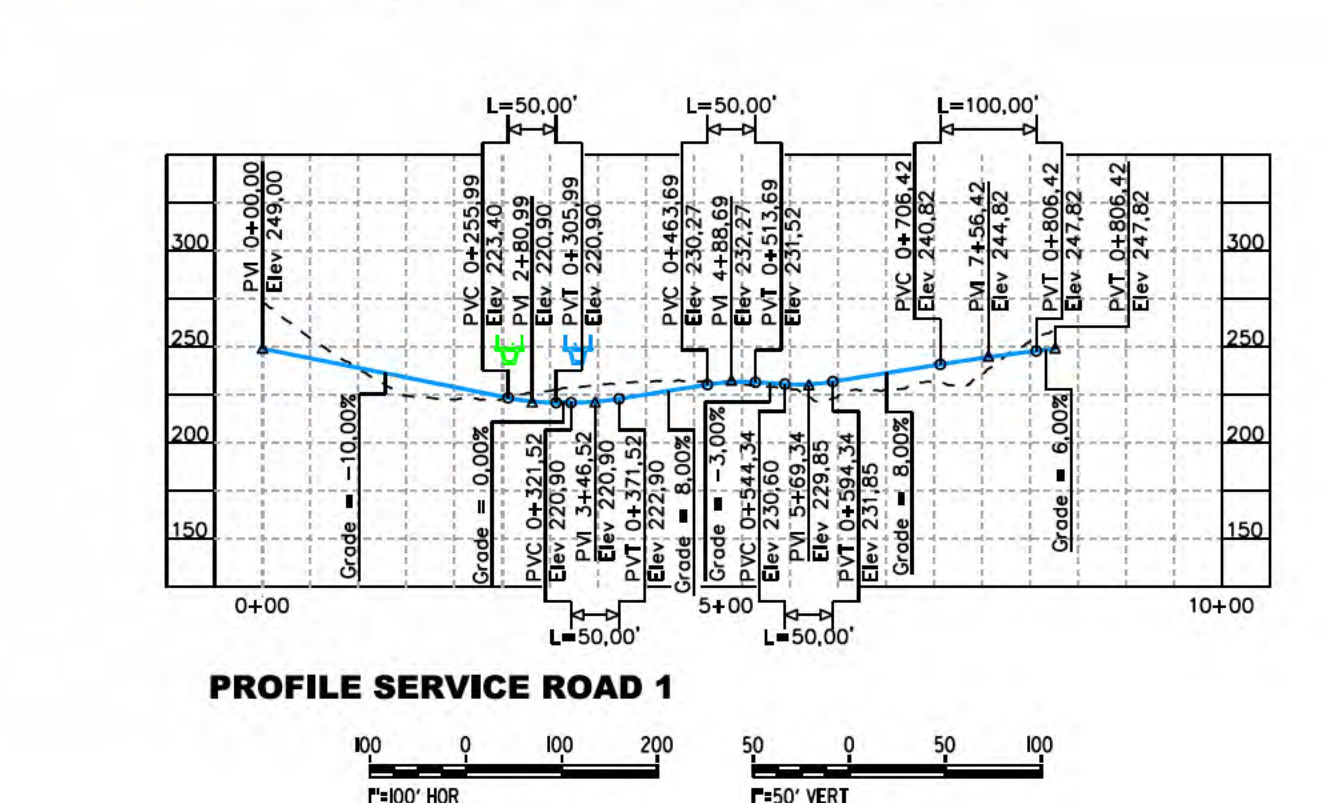
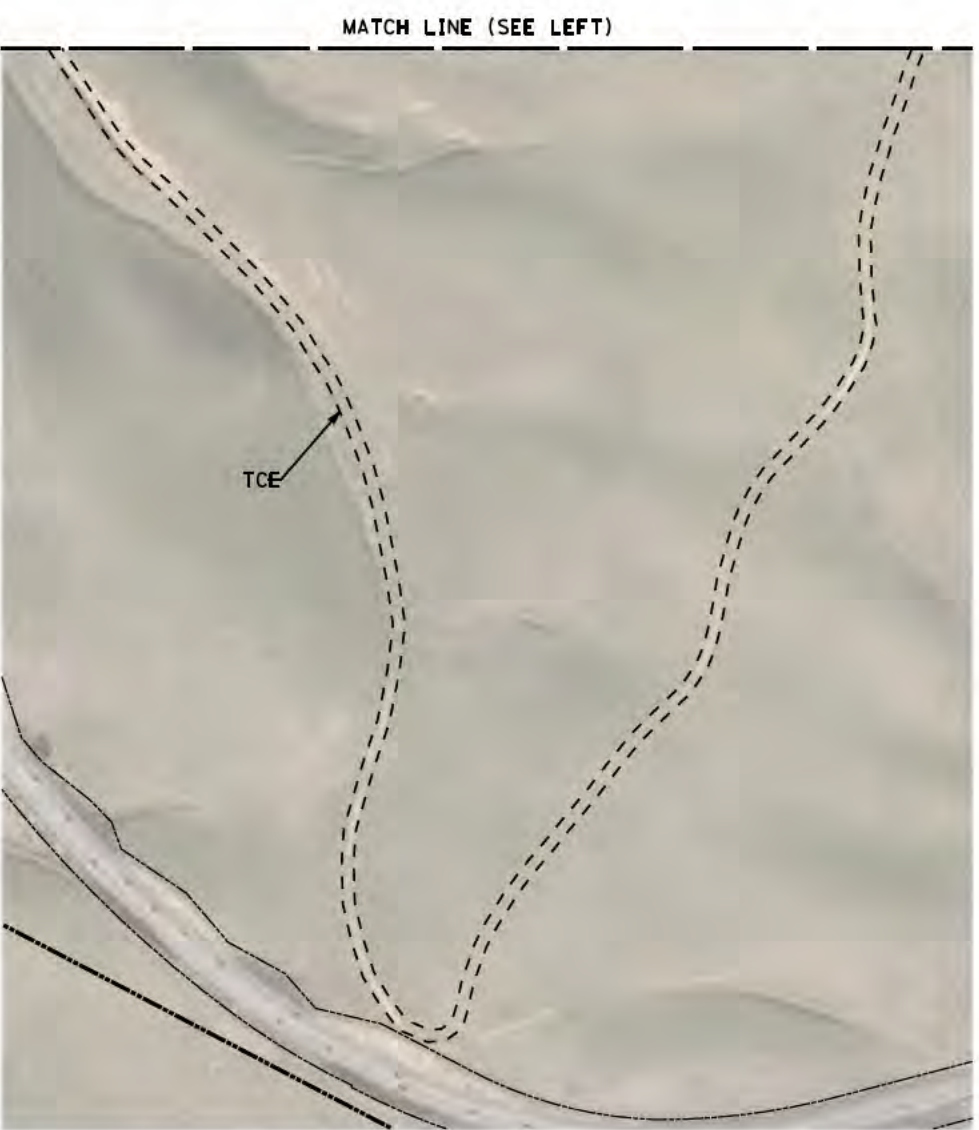
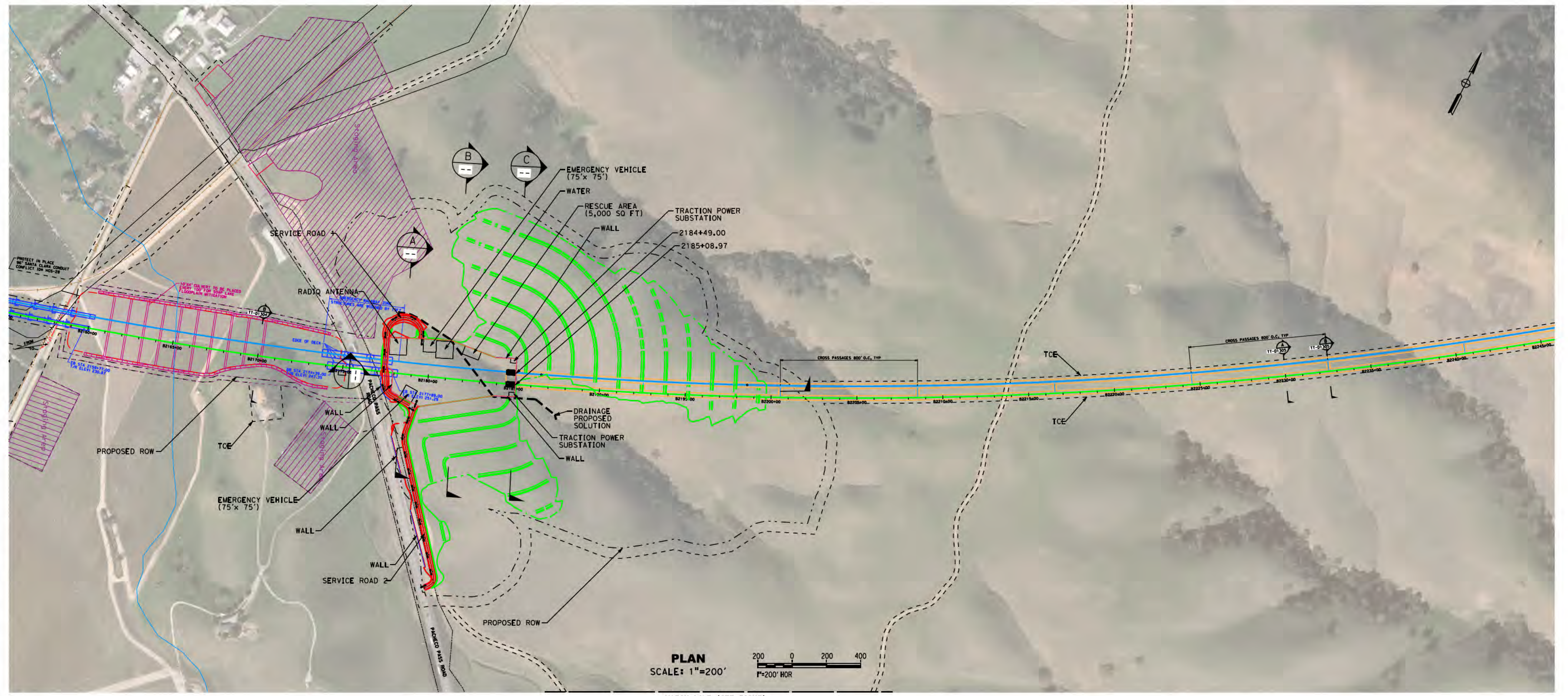

**KEYMAP**

**SAN JOSE TO CVY EIR/S: VOLUME III**  
**ALTERNATIVE 3**  
**BOOK 3D**  
**SHEET 135 OF 237**

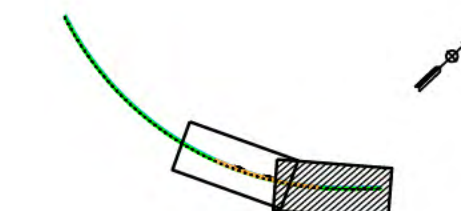
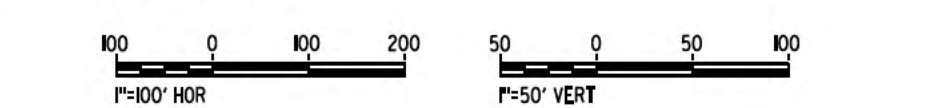
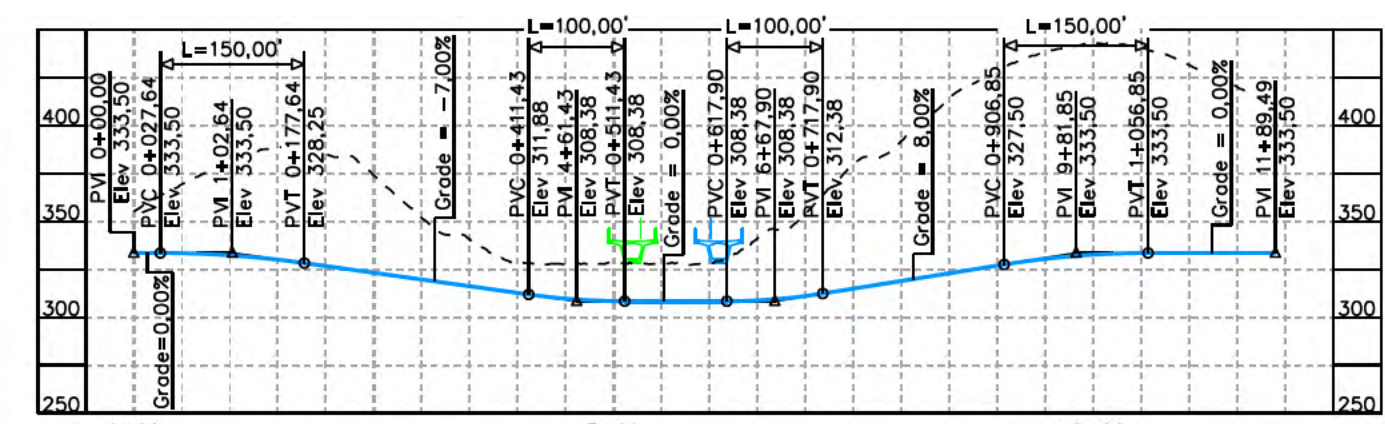
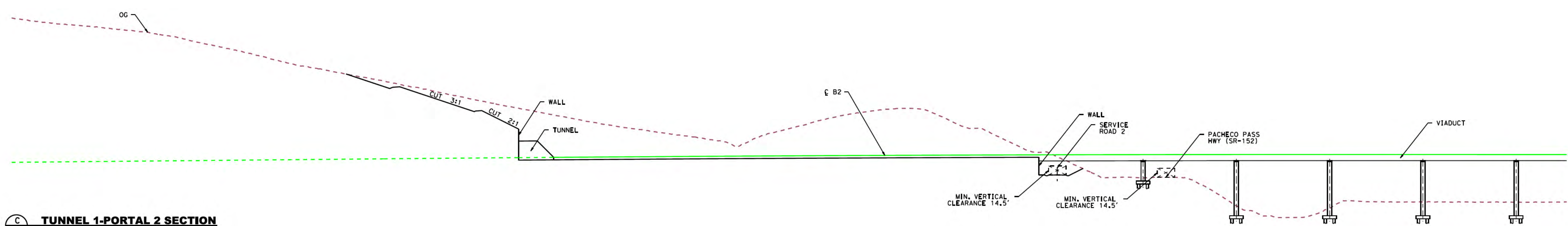
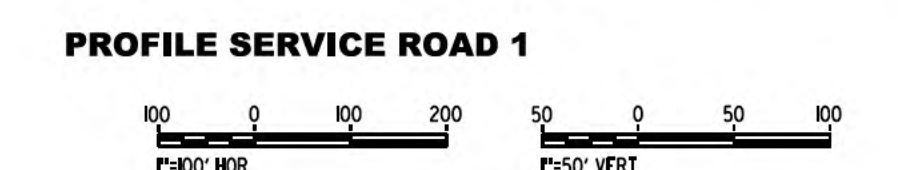
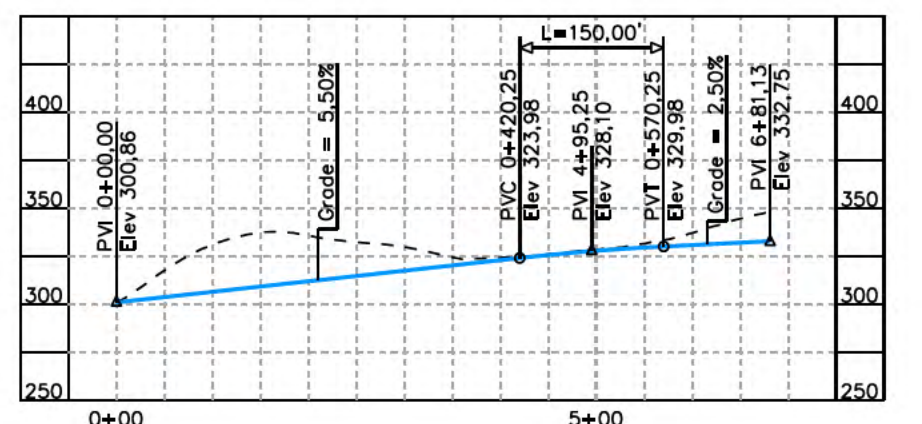
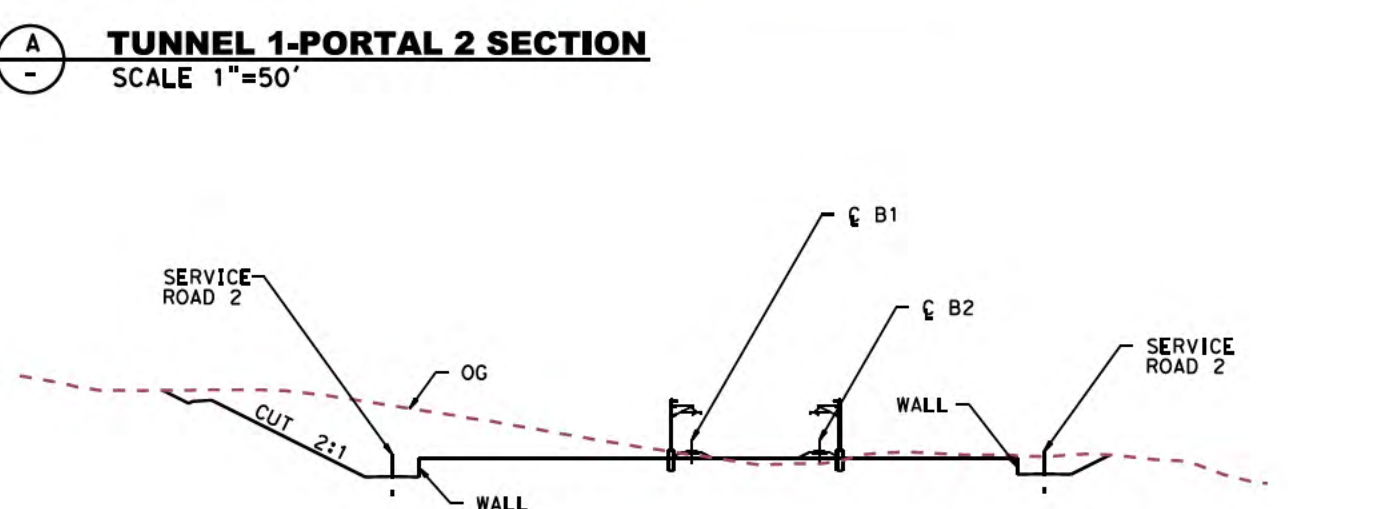
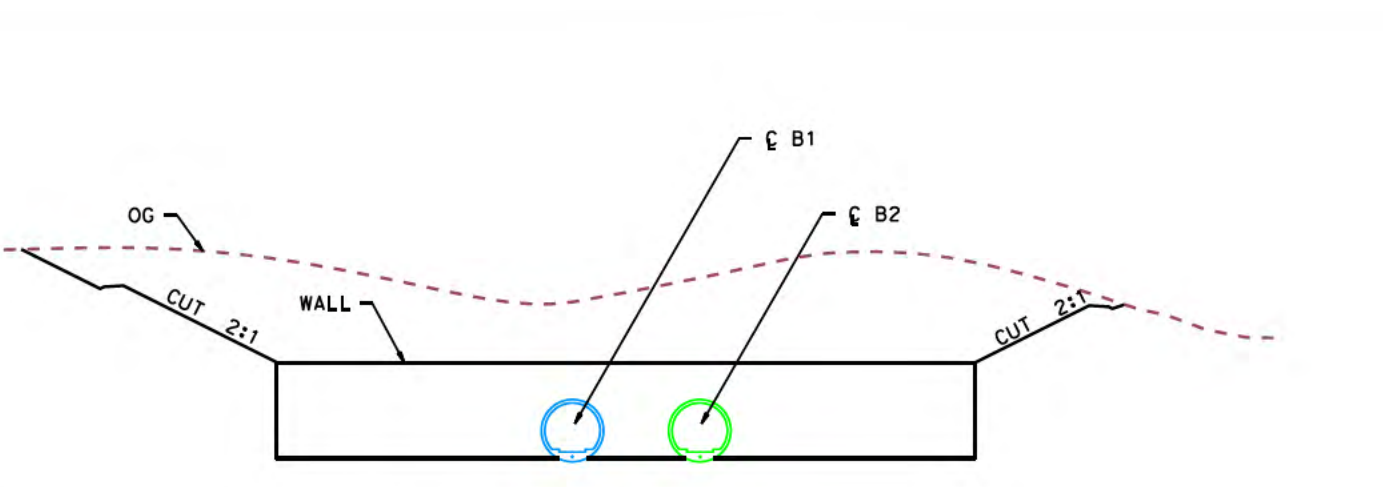
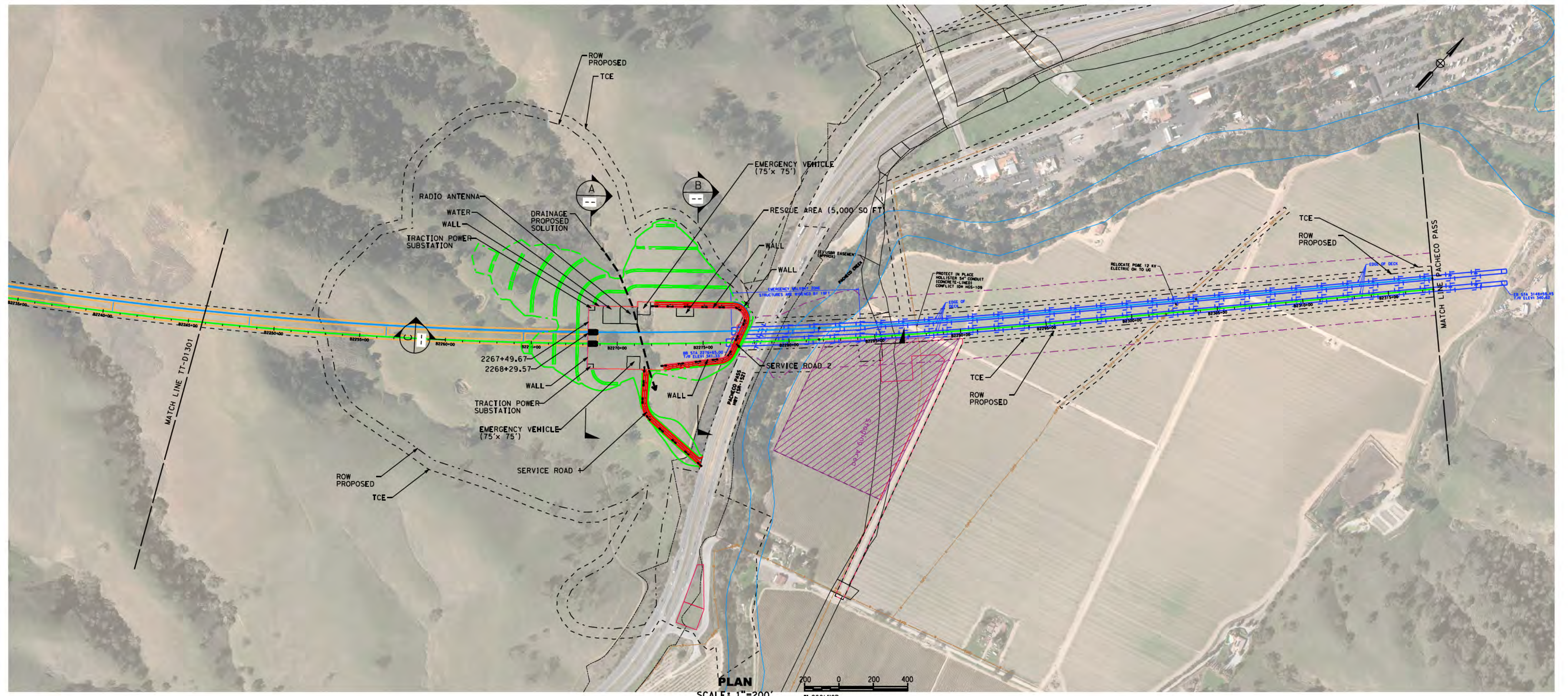

**SAN JOSE TO CVY EIR/S: VOLUME III  
ALTERNATIVE 3  
BOOK 3D  
SHEET 136 OF 237**

2021 RECORD SET PERD NOVEMBER 30, 2021 NOT FOR CONSTRUCTION	<b>HNTB</b> 1111 Broadway 9th Floor Oakland, CA 94607	<b>CALIFORNIA</b> High-Speed Rail Authority	<b>CALIFORNIA HIGH-SPEED TRAIN PROJECT</b> SAN JOSE TO MERCED PACHECO PASS TUNNEL TUNNEL 1 - PORTAL 2	CONTRACT NO. HSR15-34 DRAWING NO. TN-D1302 SCALE AS SHOWN SHEET NO.
---	--	--	--	--

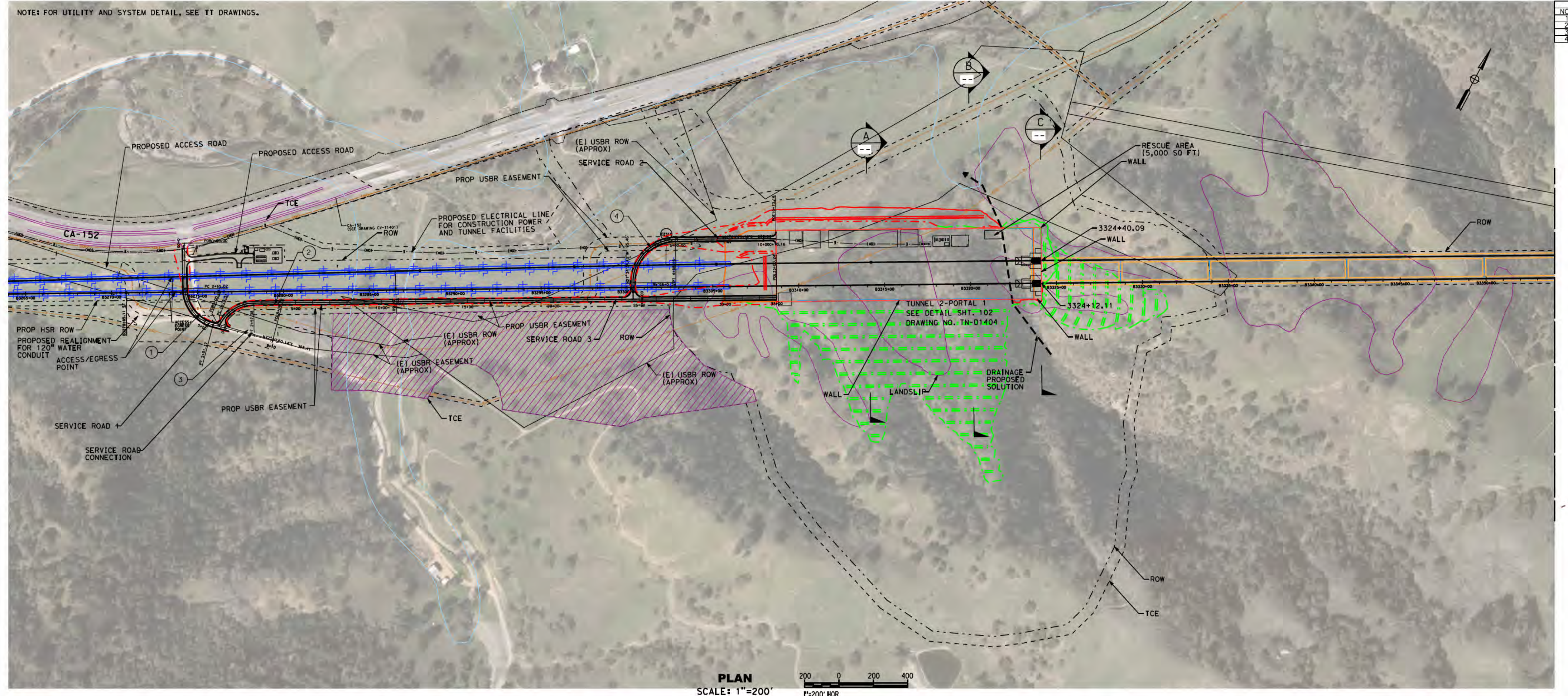

PLAN  
SCALE: 1"=200'

CURVE DATA SERVICE ROAD					
NO.	R	Δ	ΔS	ΔT	ΔY
1	220	136° 35' 22.20"	524.466	552.688	
2	220	162° 35' 51.55"	176.890	162.014	
3	220	89° 59' 55.55"	176.890	162.014	
4	250	89° 59' 55.55"	392.689	249.999	

A  
TUNNEL 2-PORTAL 1 SECTION  
SCALE 1"=50'

B  
TUNNEL 2-PORTAL 1 SECTION  
SCALE 1"=50'

C  
TUNNEL 2-PORTAL 1 SECTION  
SCALE 1"=50'

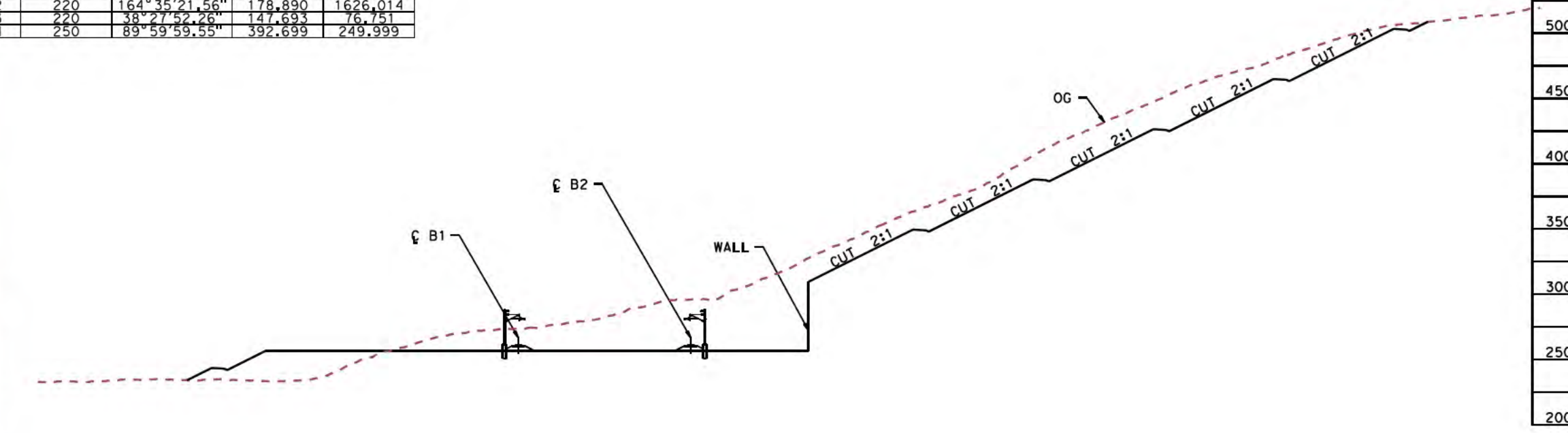

PROFILE - SERVICE ROAD 1  
SCALE: 1"=100' HOR, 1"=50' VERT

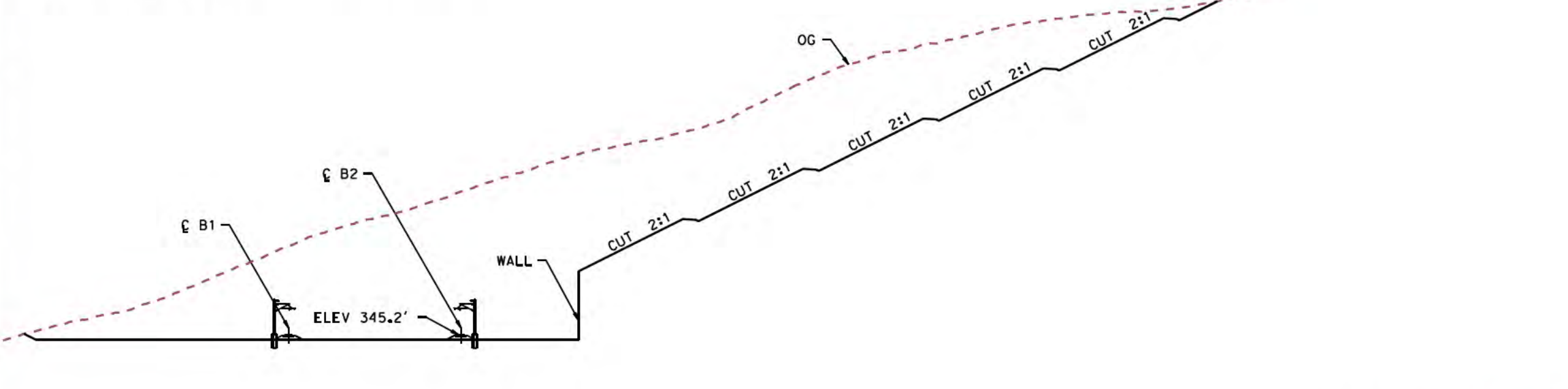

PROFILE - SERVICE ROAD 2  
SCALE: 1"=100' HOR, 1"=50' VERT

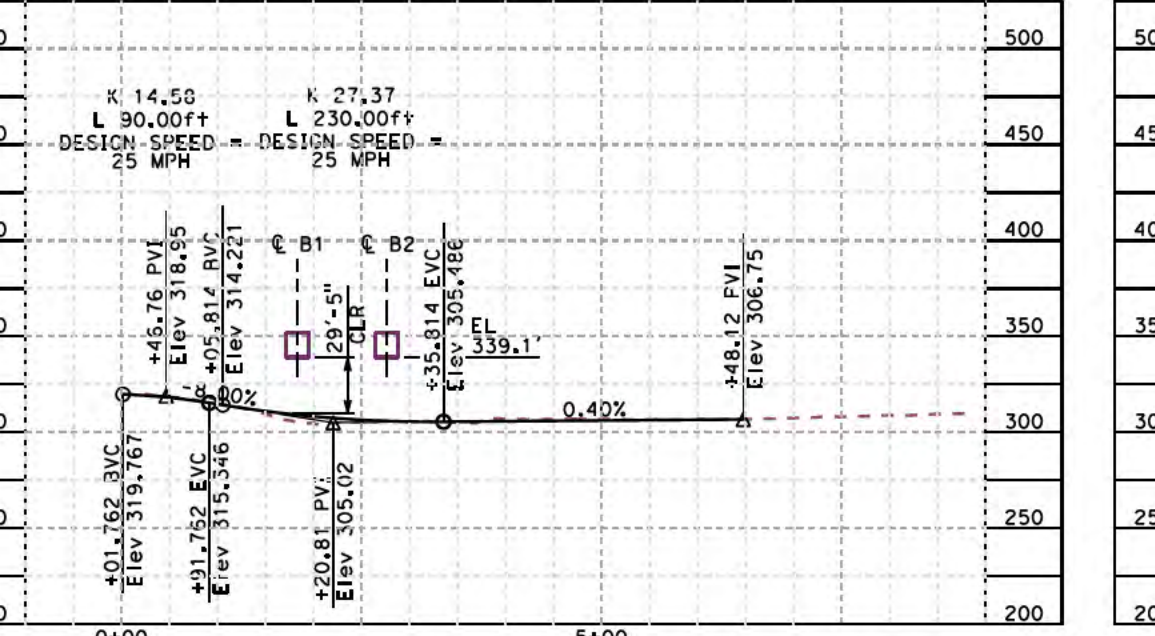

PROFILE - SERVICE ROAD 3  
SCALE: 1"=100' HOR, 1"=50' VERT

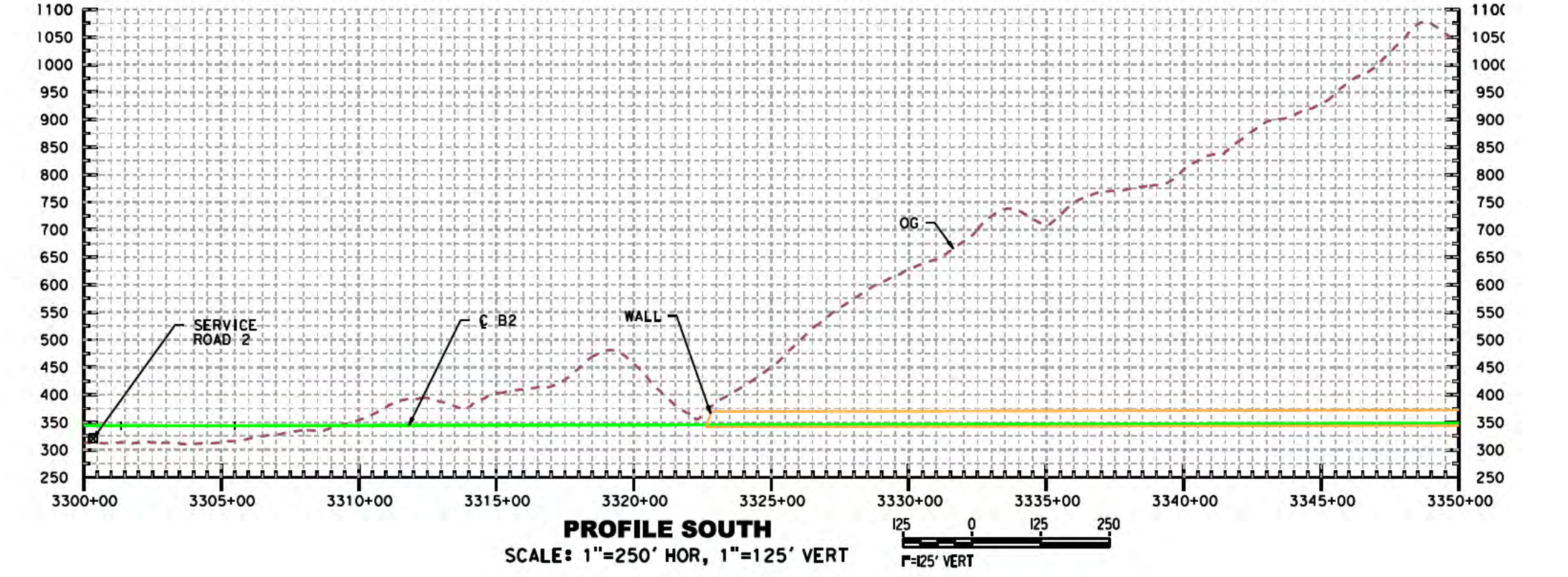

PROFILE SOUTH  
SCALE: 1"=250' HOR, 1"=125' VERT

**SAN JOSE TO CVY EIR/S: VOLUME III**  
**ALTERNATIVE 3**  
**BOOK 3D**  
**SHEET 137 OF 237**

2021 RECORD SET P&P  
NOVEMBER 30, 2021  
NOT FOR CONSTRUCTION

**HNTB**  
1111 Broadway  
9th Floor  
Oakland, CA 94607

**CALIFORNIA**  
High-Speed Rail Authority

**CALIFORNIA HIGH-SPEED TRAIN PROJECT**  
**SAN JOSE TO MERCED**  
PACHECO PASS  
TUNNEL  
TUNNEL 2 - PORTAL 1

CONTRACT NO. HSR15-34  
DRAWING NO. TN-D1404  
SCALE AS SHOWN  
SHEET NO.

0:20/2021 10:14:52 PM C:\p02\_2021\101452\_P02\_CAD\00001.dwg CALHSR-01  
 0:20/2021 10:14:52 PM C:\p02\_2021\101452\_P02\_CAD\00001.dwg CALHSR-01  
 0:20/2021 10:14:52 PM C:\p02\_2021\101452\_P02\_CAD\00001.dwg CALHSR-01

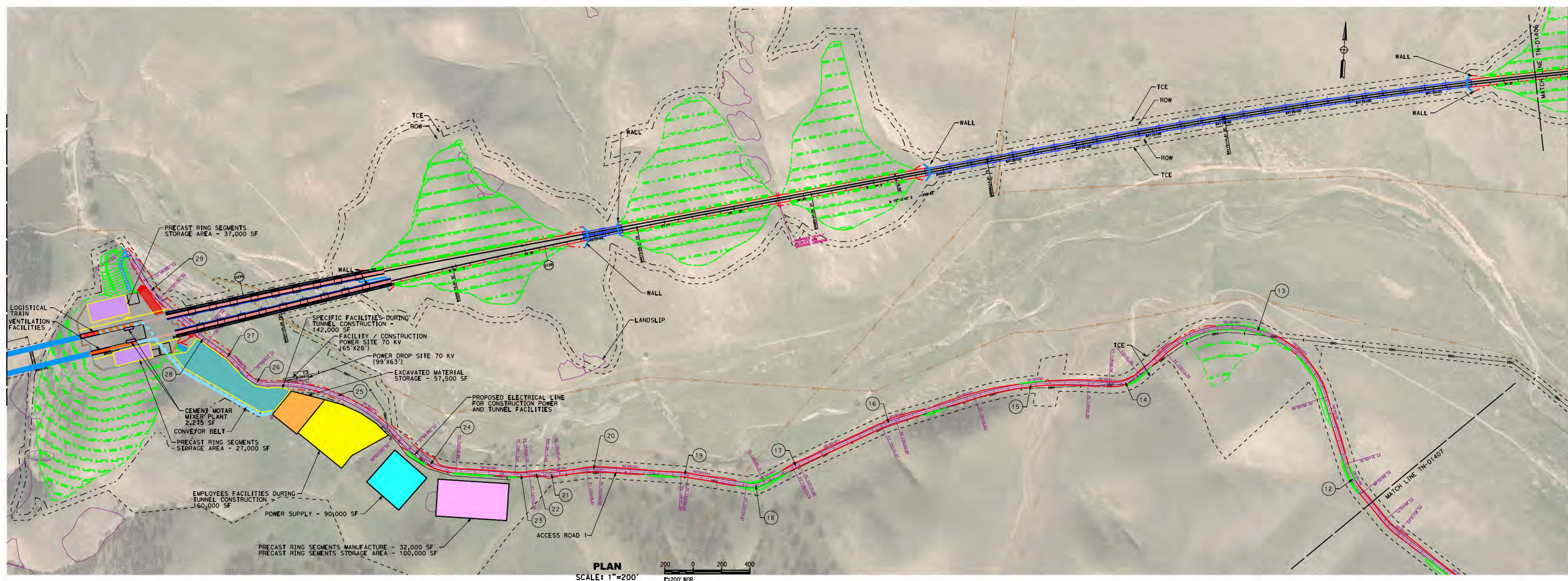

PLAN  
SCALE: 1"=200'

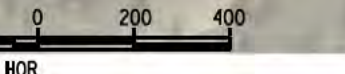

CURVE DATA ACCESS ROAD				
NO.	R	ANGLE	PC	PT
1	200	24°10'26.32"	84.383	42.829
2	225	31°00'52.48"	121.794	62.429
3	200	24°10'26.32"	141.955	73.811
4	130	90°1'43.45"	204.269	130.065
5	250	41°42'38.13"	178.222	93.857
6	200	35°23'39.02"	123.426	63.81
7	200	30°12'48.85"	105.465	53.990
8	100	57°17'44.81"	202.813	100.667
9	500	17°56'40.21"	150.395	78.944
10	300	11°32'59.99"	60.476	30.341
11	600	12°42'29.71"	131.681	66.106
12	600	22°29'22.50"	235.512	119.291
13	700	11°40'15.65"	133.23	107.682
14	300	44°52'23.37"	235.130	229.158
15	2250	20°38'3.81"	810.311	409.532
16	800	7°54'32.18"	110.430	55.303
17	1000	2°56'33.16"	51.857	25.664
18	200	37°11'55.44"	129.848	67.305
19	500	5°42'46.30"	49.854	21.948
20	500	11°28'43.98"	109.171	50.294
21	500	13°2'33.88"	113.819	57.157
22	500	11°50'23.37"	100.413	50.376
23	500	9°56'33.07"	86.465	43.492
24	500	42°48'20.04"	374.549	195.976
25	1150	49°15'53.32"	391.406	531.863
26	200	48°5'23.14"	160.041	89.339
27	600	10°45'46.18"	112.708	56.520
28	600	7°54'26.12"	82.981	41.957
29	600	16°11'57.94"	169.640	85.390

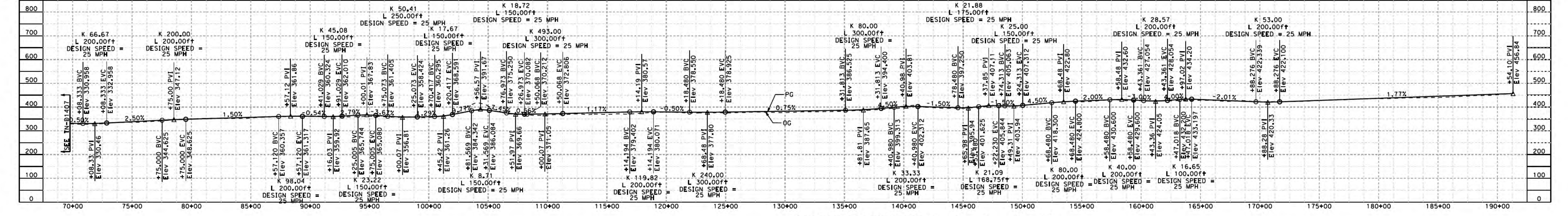

PROFILE ACCESS ROAD 1  
SCALE: 1"=250' HOR, 1"=125' VERT



NOTE:  
1. REFER TO GENERAL NOTES SHEETS GE-B0001 AND GE-B0002 FOR NOTES.

SAN JOSE TO CVY EIR/S: VOLUME III  
 ALTERNATIVE 3  
 BOOK 3D  
 SHEET 138 OF 237

2021 RECORD SET PBD NOVEMBER 30, 2021 NOT FOR CONSTRUCTION		1111 Broadway 9th Floor Oakland, CA 94607		<b>CALIFORNIA HIGH-SPEED TRAIN PROJECT</b> <b>SAN JOSE TO MERCED</b> TUNNEL TUNNEL PORTAL 2 ACCESS ROAD	CONTRACT NO. HSR15-34 DRAWING NO. TD-D-1405 SCALE AS SHOWN SHEET NO.
--	--	---	--	--	---

11/20/2021 09:14:14 AM C:\Users\hntb\OneDrive\Documents\1150512\1150512.dwg - 11/20/2021 09:14:14 AM

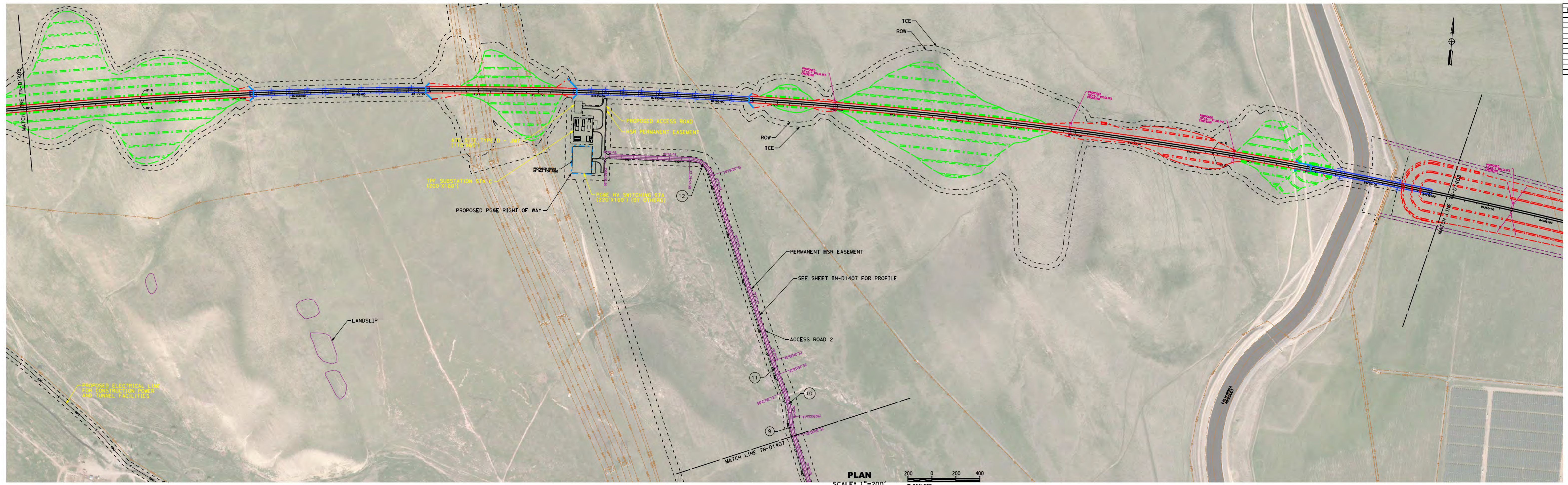

CURVE DATA ACCESS ROAD 2				
NO.	R	Δ	L	T
1	50	17°35'37.70"	15.353	7.738
2	500	7°18'49.17"	63.821	31.954
3	500	12°26'28.27"	109.21	54.499
4	500	10°56'19.97"	95.460	47.875
5	500	15°46'22.20"	137.695	69.235
6	500	10°01'23.19"	81.468	41.846
7	292	19°16'47.16"	98.278	49.608
8	2000	2°40'22.15"	203.837	102.607
9	700	13°54'36.03"	189.943	94.991
10	700	17°23'12.58"	216.493	109.117
11	2000	1°10'18.19"	122.351	61.195
12	200	69°44'2.72"	243.418	119.351

**NOTE:**  
 1. REFER TO GENERAL NOTES SHEETS GE-B0001 AND GE-B0002 FOR NOTES.

**SAN JOSE TO CVY EIR/S: VOLUME III**  
**ALTERNATIVE 3**  
**BOOK 3D**  
**SHEET 139 OF 237**

2021 RECORD SET P&E NOVEMBER 30, 2021 NOT FOR CONSTRUCTION		1111 Broadway 9th Floor Oakland, CA 94607		<b>CALIFORNIA HIGH-SPEED TRAIN PROJECT</b> <b>SAN JOSE TO MERCED</b> PACHECO PASS TUNNEL TUNNEL PORTAL 2 ACCESS ROAD	CONTRACT NO. HSR15-34 DRAWING NO. TN-D1406 SCALE AS SHOWN SHEET NO.
--	--	---	--	--	---



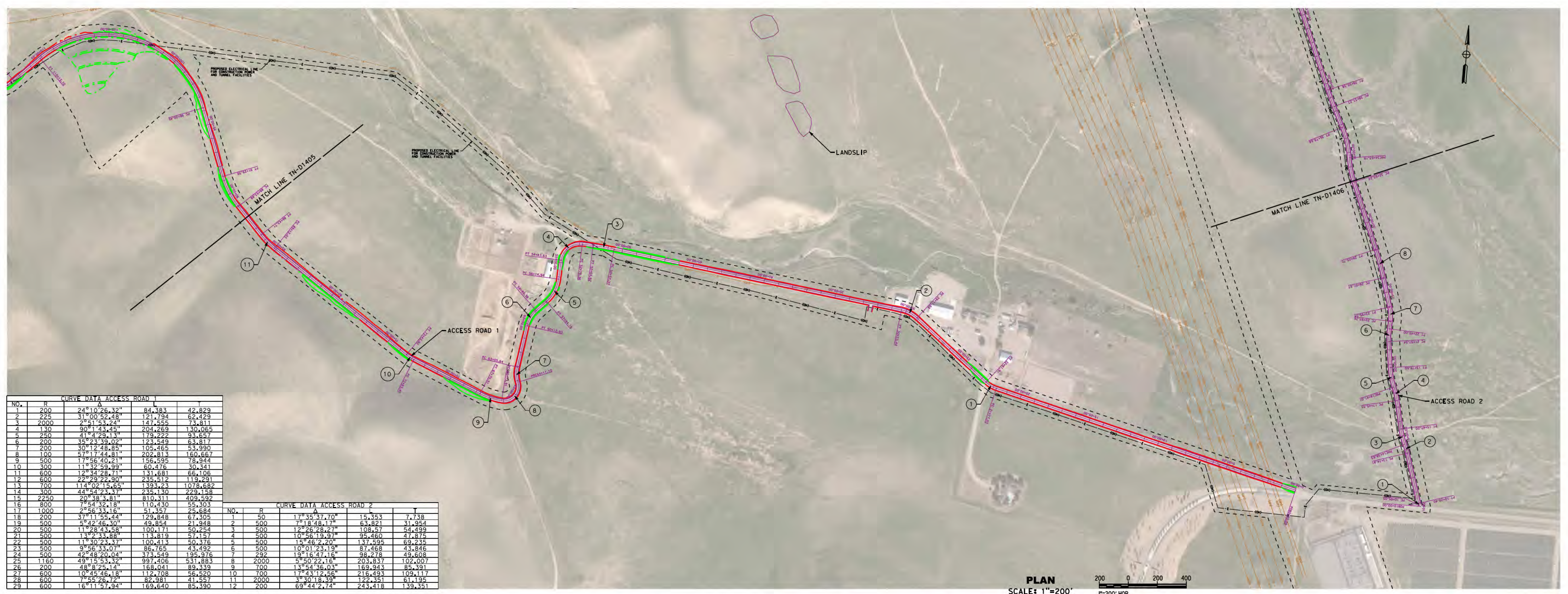

**CURVE DATA ACCESS ROAD 1**

NO.	R	A	LC	PC	PT	EC	LC
1	200	24°10'26.32"	84.383	42.829			
2	225	31°00'52.48"	121.794	62.429			
3	2000	2°51'43.24"	147.459	73.811			
4	130	90°14'43.45"	204.269	130.065			
5	250	35°23'59.02"	123.222	63.877			
6	200	30°12'48.85"	105.465	53.990			
7	100	57°17'46.81"	202.813	100.667			
8	500	17°56'40.81"	156.393	78.944			
9	300	11°32'59.99"	60.476	30.341			
10	600	17°34'28.71"	111.681	66.106			
11	600	22°29'22.90"	235.112	113.291			
12	700	11°40'15.65"	1393.23	1078.682			
13	300	42°54'23.37"	235.130	228.158			
14	2250	2°58'33.81"	810.111	409.592			
15	800	7°54'32.18"	110.430	55.303			
16	1000	2°56'33.16"	51.357	25.684			
17	200	37°11'55.44"	129.848	67.305			
18	500	5°42'26.30"	49.854	21.948			
19	500	11°28'43.58"	100.171	50.254			
20	500	10°56'19.97"	57.157	28.875			
21	500	11°23'33.88"	113.819	57.157			
22	500	11°30'23.37"	100.413	50.376			
23	500	9°58'33.07"	86.165	43.492			
24	500	42°48'20.04"	373.849	195.976			
25	1150	49°15'53.32"	991.406	531.883			
26	200	48°18'25.14"	188.041	89.439			
27	600	10°45'46.18"	112.708	56.520			
28	600	7°51'49.12"	82.381	41.591			
29	600	16°11'47.94"	169.840	85.390			

**CURVE DATA ACCESS ROAD 2**

NO.	R	A	LC	PC	PT	EC	LC
1	50	17°35'37.70"	15.353	7.738			
2	500	7°18'48.17"	63.821	31.954			
3	500	12°28'28.27"	108.57	54.499			
4	500	10°56'19.97"	95.460	47.875			
5	500	15°26'22.20"	137.295	69.235			
6	500	3°50'11.30"	122.351	61.191			
7	200	69°24'27.24"	245.218	139.351			

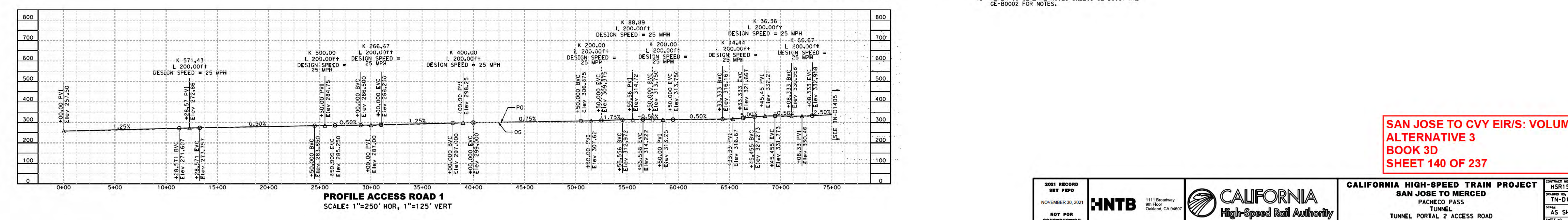
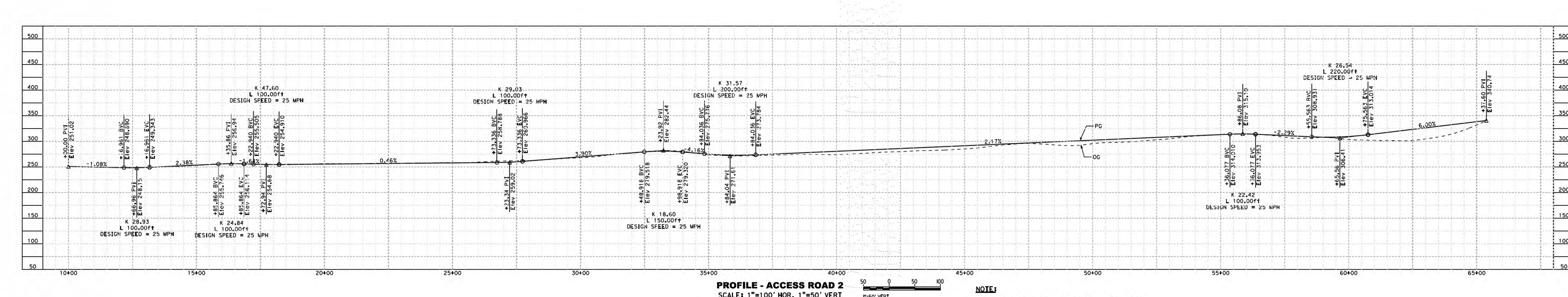

**SAN JOSE TO CVY EIR/S: VOLUME III**  
**ALTERNATIVE 3**  
**BOOK 3D**  
**SHEET 140 OF 237**

2021 RECORD SET PERD NOVEMBER 30, 2021 HNTB NOT FOR CONSTRUCTION	1111 Broadway 9th Floor Oakland, CA 94607		<b>CALIFORNIA HIGH-SPEED TRAIN PROJECT</b> <b>SAN JOSE TO MERCED</b> PACHECO PASS TUNNEL TUNNEL PORTAL 2 ACCESS ROAD	CONTRACT NO. HSR15-34 DRAWING NO. TN-D1407 SCALE AS SHOWN SHEET NO.
---	---	--	---	--

NOTES:  
REFER TO COMPOSITE DRAWINGS FOR TUNNEL PROFILE DETAILS.



**PROFILE**  
SCALE: 1"=1600' HOR, 1"=100' VERT

**SAN JOSE TO CVY EIRS: VOLUME III**  
**ALTERNATIVE 3**  
**BOOK 3D**  
**SHEET 141 OF 237**

2021 RECORD SET PBD  
NOVEMBER 30, 2021  
NOT FOR CONSTRUCTION



1111 Broadway  
9th Floor  
Oakland, CA 94607



**CALIFORNIA HIGH-SPEED TRAIN PROJECT**  
**SAN JOSE TO MERCED**  
PACHECO PASS  
TUNNEL  
LONGITUDINAL PROFILE

CONTRACT NO. HSR15-34  
DRAWING NO. TN-D1408  
SCALE AS SHOWN  
SHEET NO.

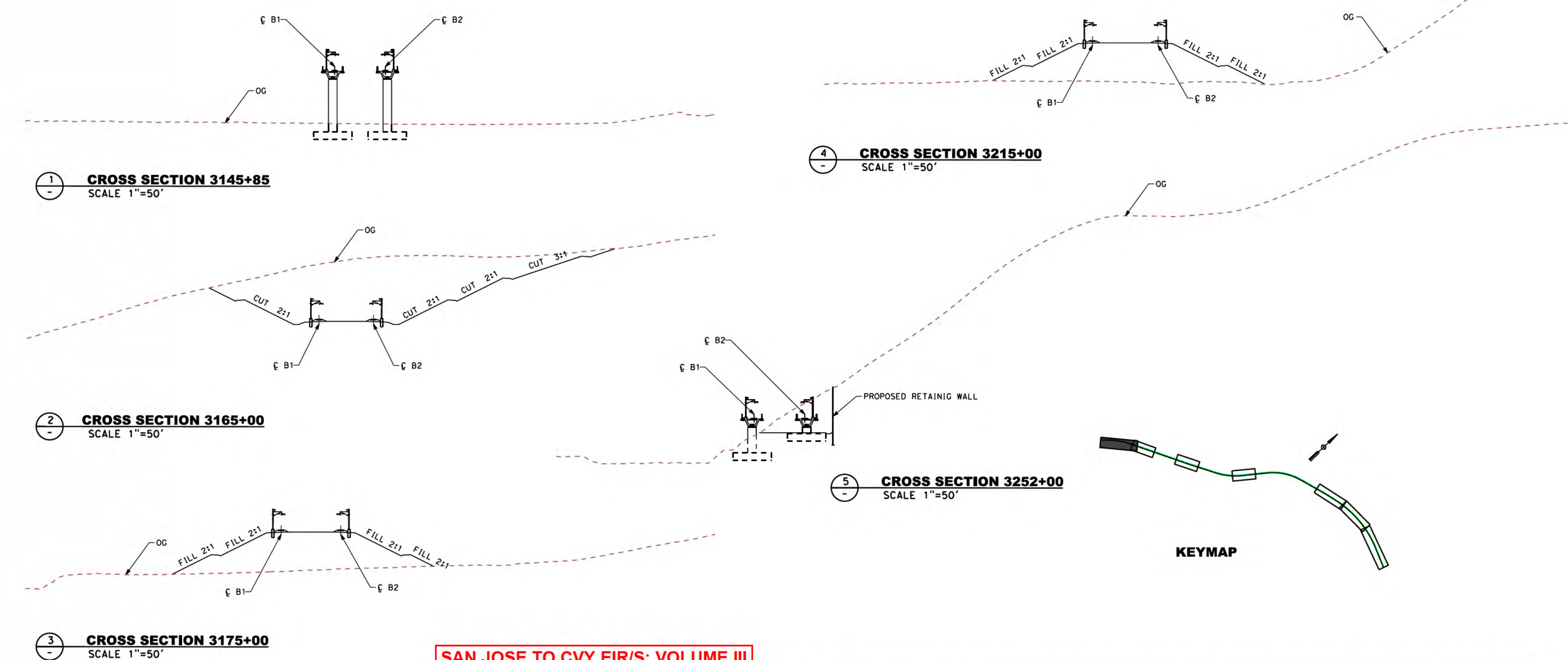
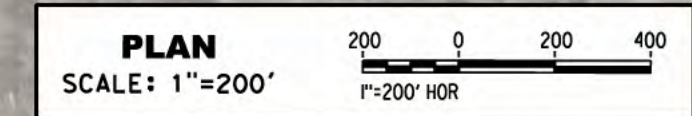
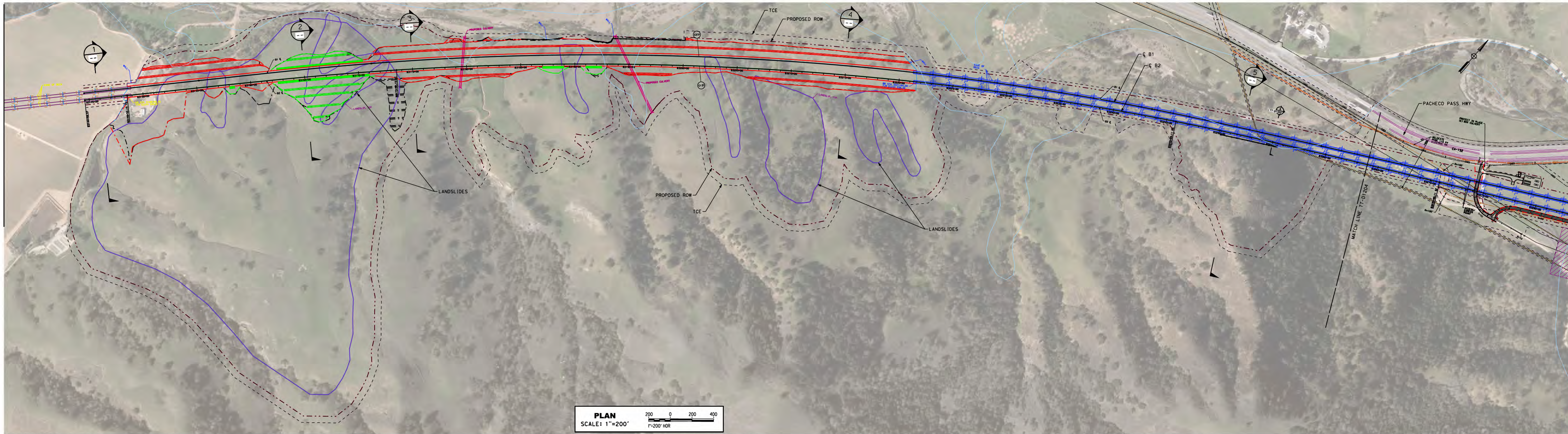

**SAN JOSE TO CVY EIR/S: VOLUME III  
ALTERNATIVE 3  
BOOK 3D  
SHEET 142 OF 237**

2021 RECORD SET PBD NOVEMBER 30, 2021 NOT FOR CONSTRUCTION	<b>HNTB</b> 1111 Broadway 9th Floor Oakland, CA 94607		<b>CALIFORNIA HIGH-SPEED TRAIN PROJECT SAN JOSE TO MERCED PACHECO PASS TUNNEL GRADING DETAIL</b>	CONTRACT NO. HSR15-34 DRAWING NO. TN-D1409 SCALE AS SHOWN SHEET NO.
--	--	--	--	---

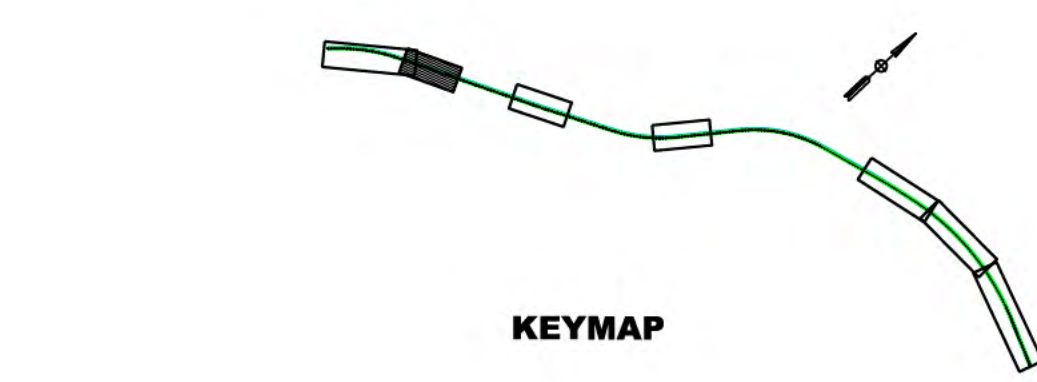
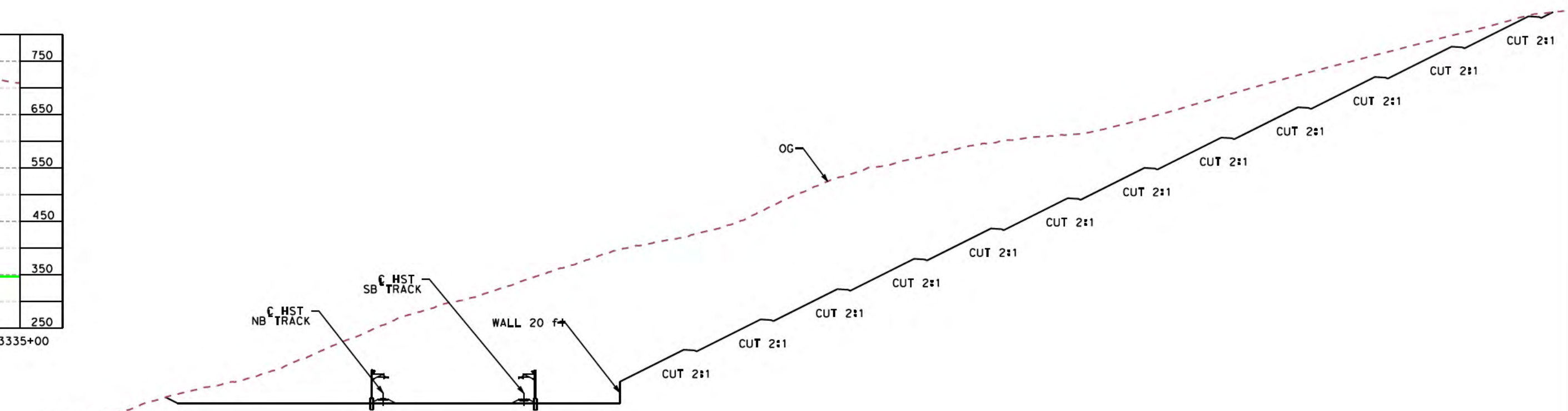
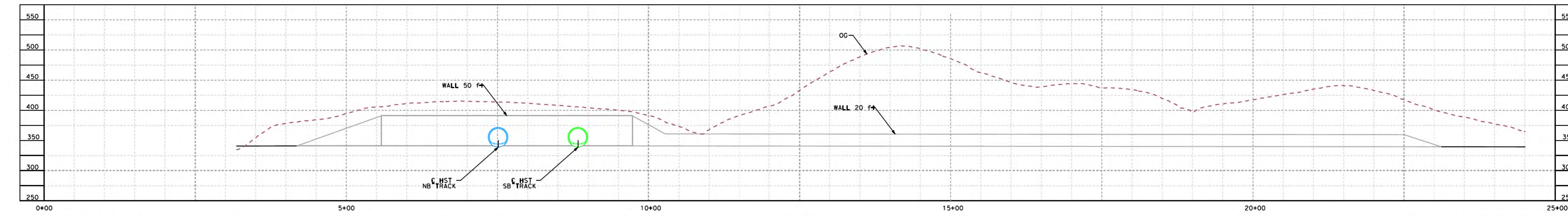
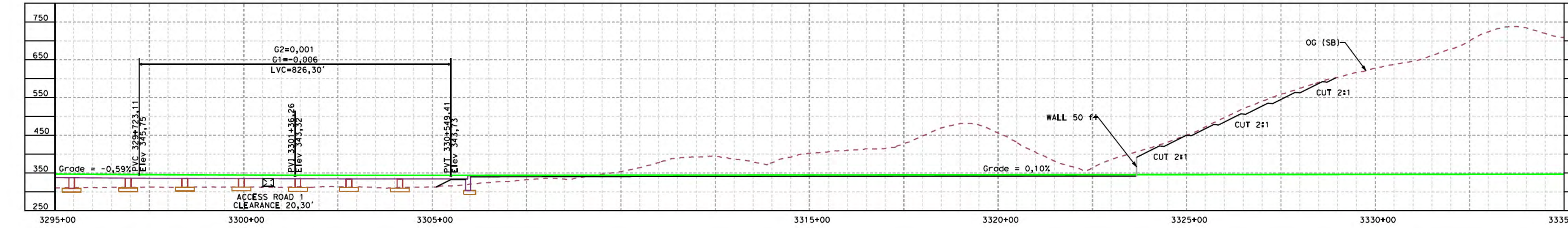
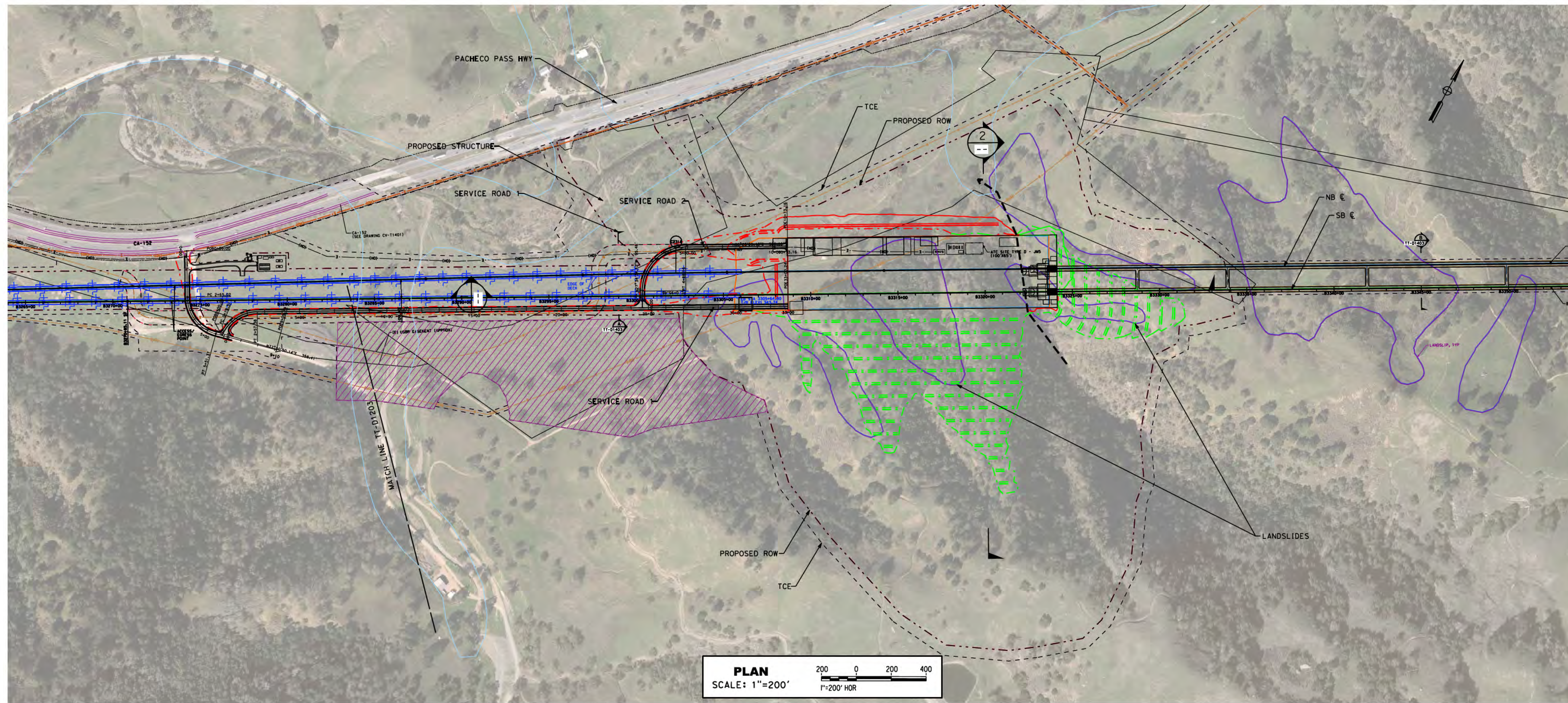

**SAN JOSE TO CVY EIR/S: VOLUME III**  
**ALTERNATIVE 3**  
**BOOK 3D**  
**SHEET 143 OF 237**

2021 RECORD SET P&ID NOVEMBER 30, 2021 NOT FOR CONSTRUCTION	<b>HNTB</b> 1111 Broadway 9th Floor Oakland, CA 94607		<b>CALIFORNIA HIGH-SPEED TRAIN PROJECT</b> <b>SAN JOSE TO MERCED</b> PACHECO PASS TUNNEL GRADING DETAIL	CONTRACT NO. HSR15-34 DRAWING NO. TN-D1410 SCALE AS SHOWN SHEET NO.
---	--	--	--	--

11/30/2021 10:52:24 AM c:\csc\p\c\dwg\hntb\111.dgn  
 c:\csc\p\c\dwg\hntb\111.dgn  
 11/30/2021 10:52:24 AM c:\csc\p\c\dwg\hntb\111.dgn

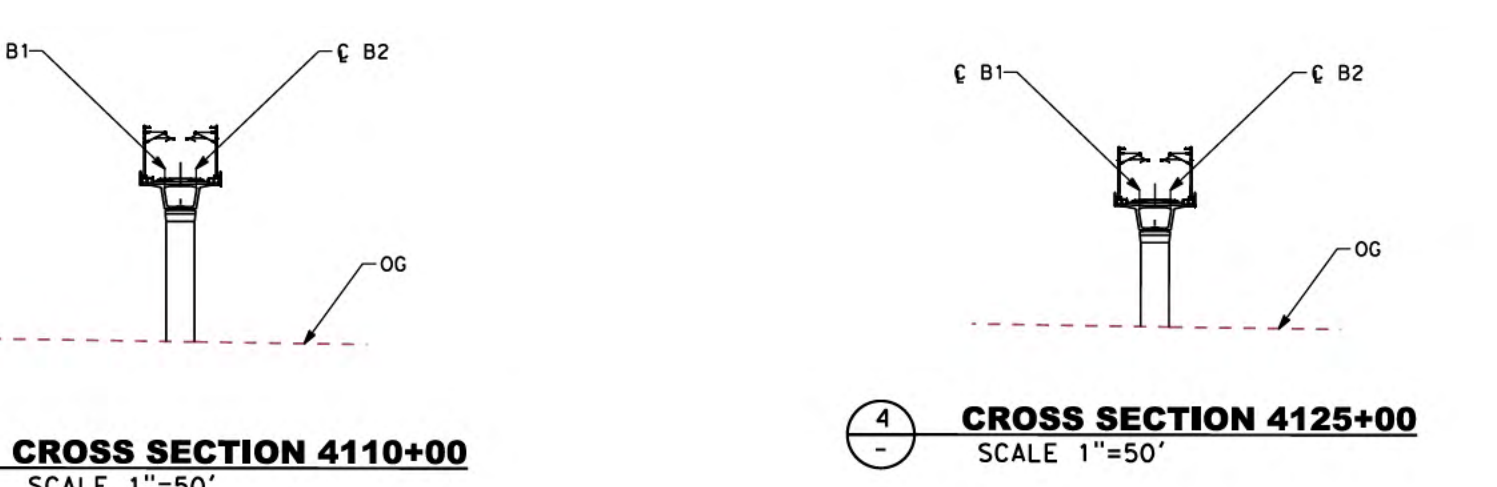
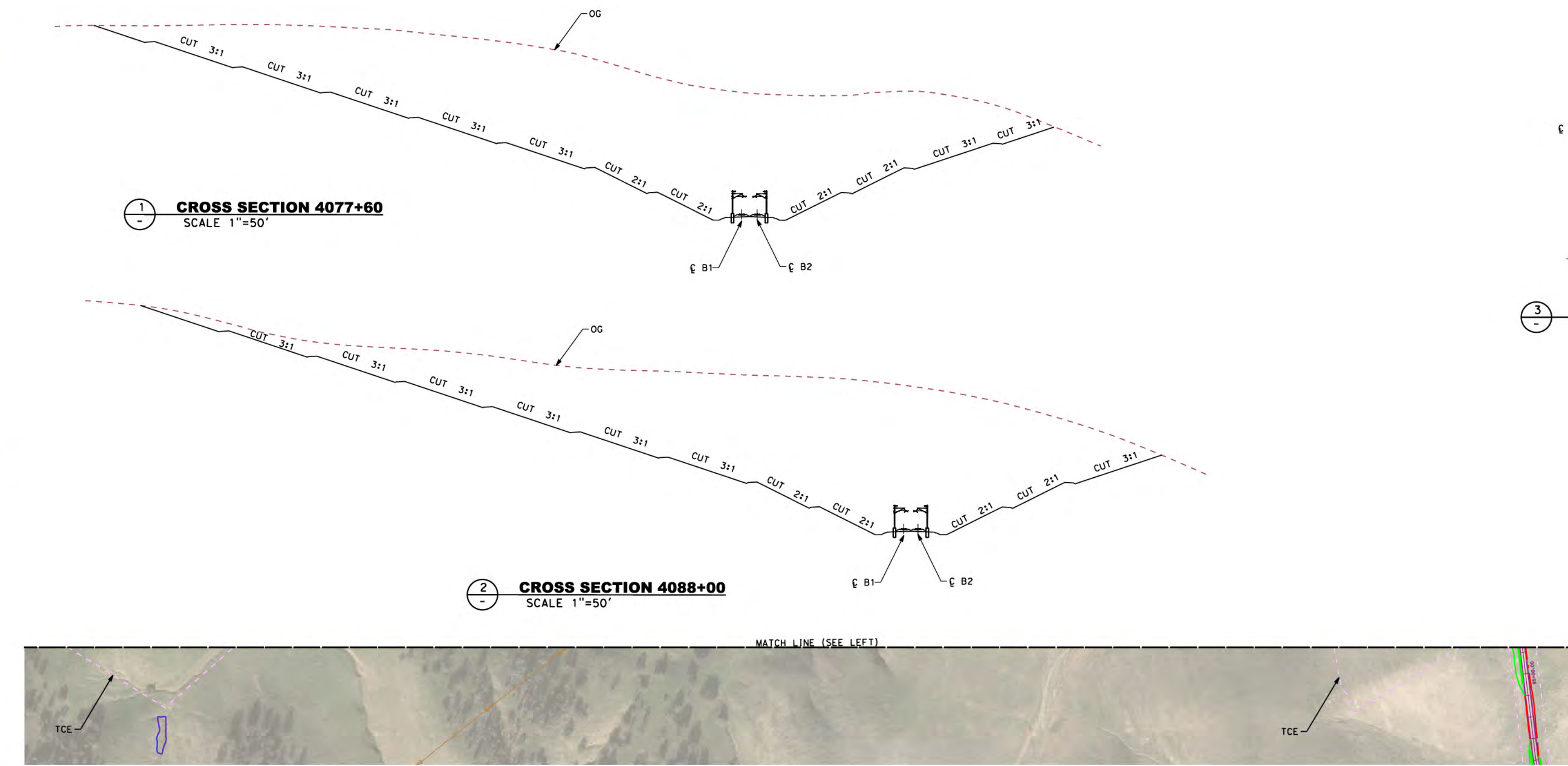
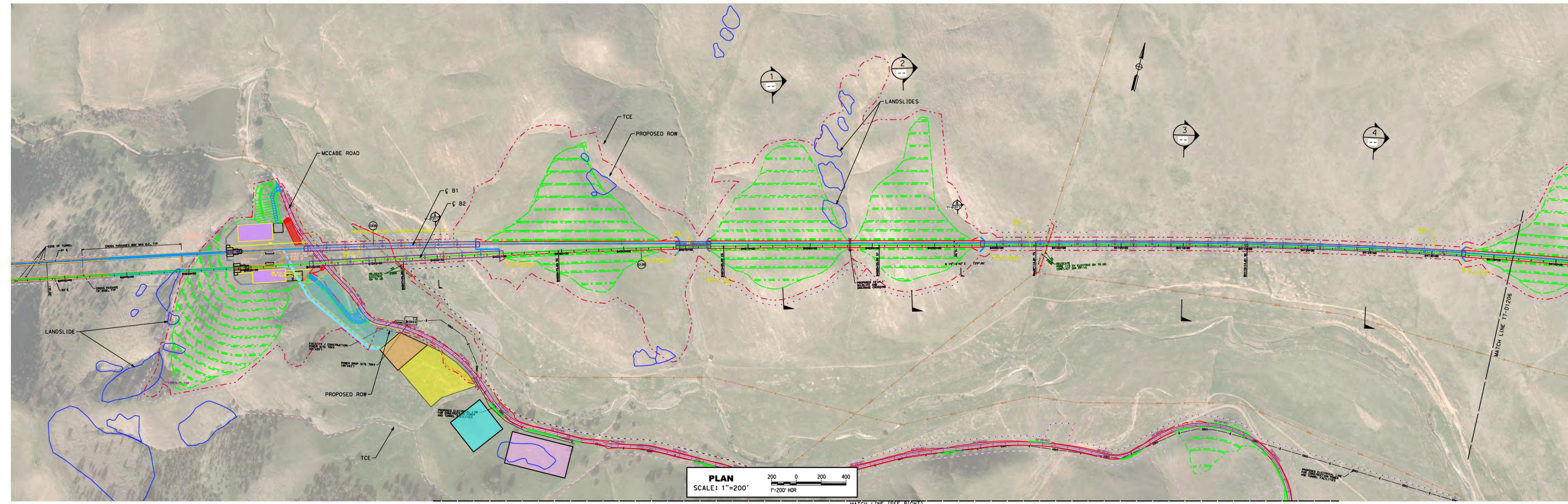

**SAN JOSE TO CVY EIR/S: VOLUME III**  
**ALTERNATIVE 3**  
**BOOK 3D**  
**SHEET 144 OF 237**

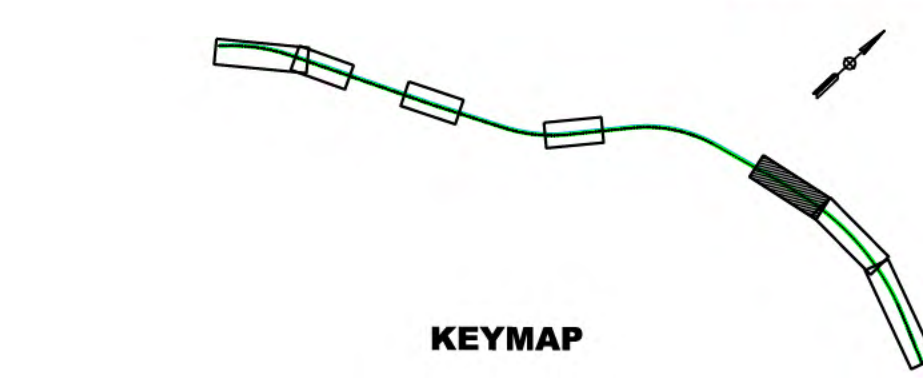

2021 RECORD SET PEPD NOVEMBER 30, 2021 NOT FOR CONSTRUCTION		1111 Broadway 9th Floor Oakland, CA 94607		<b>CALIFORNIA HIGH-SPEED TRAIN PROJECT</b> <b>SAN JOSE TO MERCED</b> PACHECO PASS TUNNEL GRADING DETAIL	CONTRACT NO. HSR15-34 DRAWING NO. TN-D1411 SCALE AS SHOWN SHEET NO.
---	--	---	--	---	--

11/20/2021 09:24:46 AM c:\p02\11-20-2021\11-20-2021\11-20-2021.dwg User: hntb\j11212.dwg

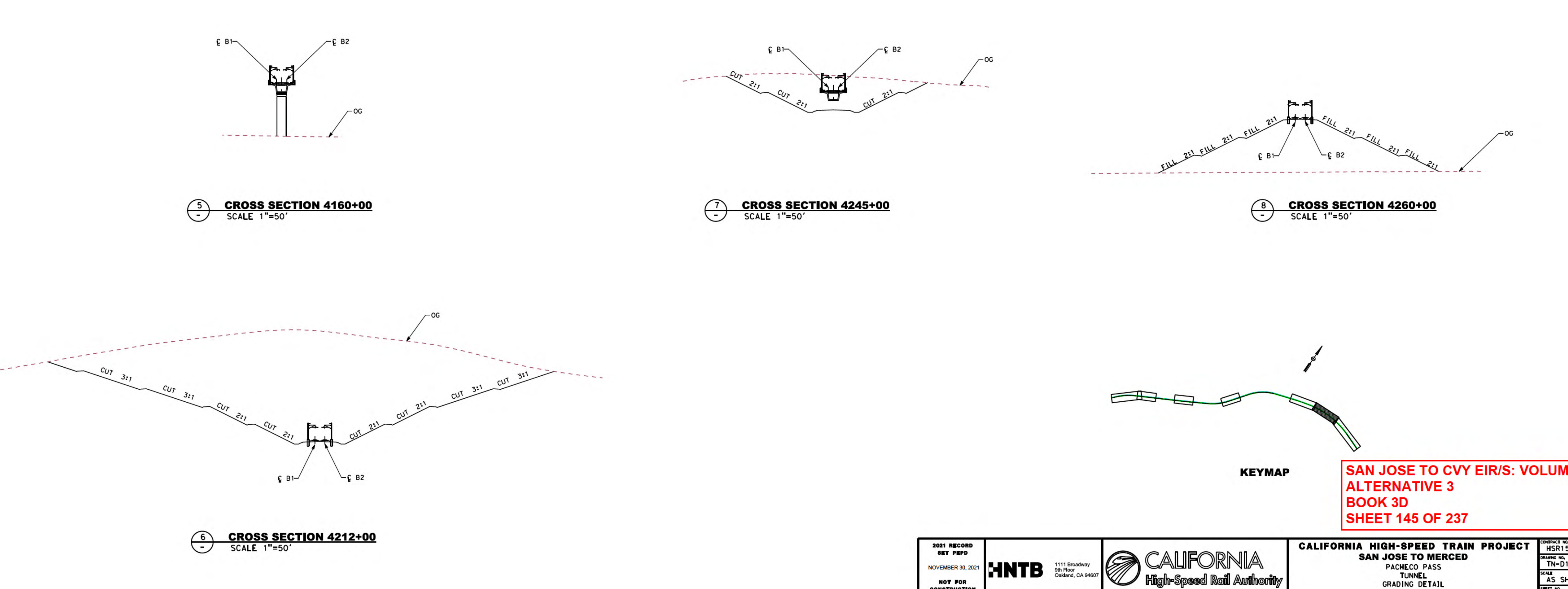
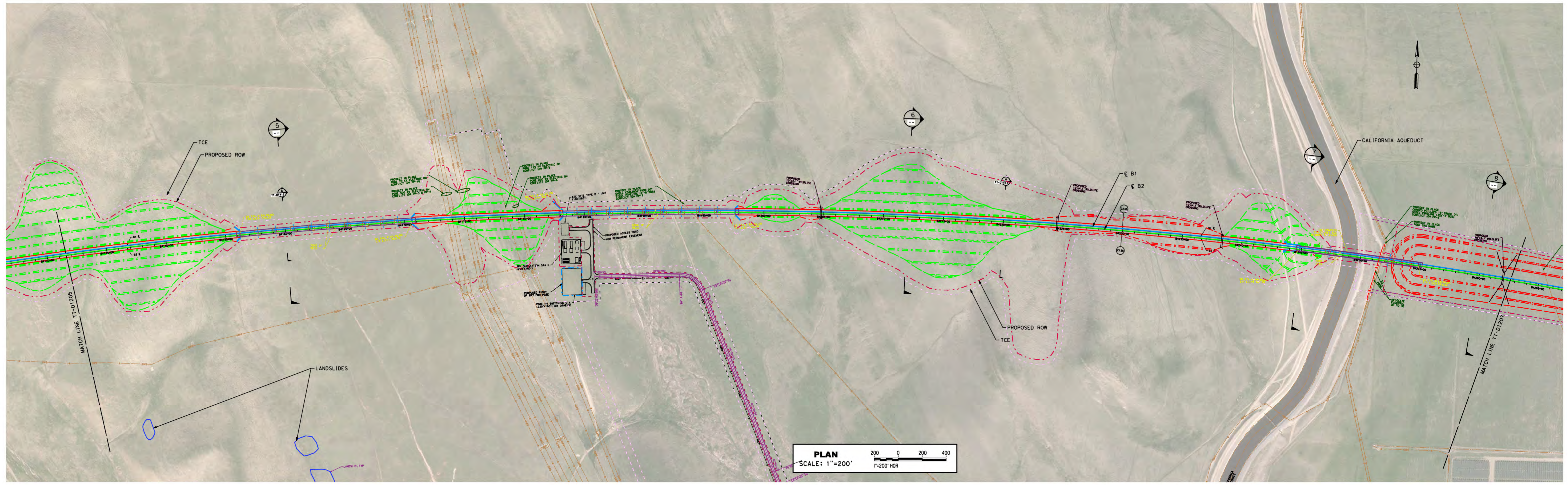

11/20/2021 09:24:28 AM C:\Users\jw\OneDrive\Documents\2021\24\wdr\1113\1113.dgn

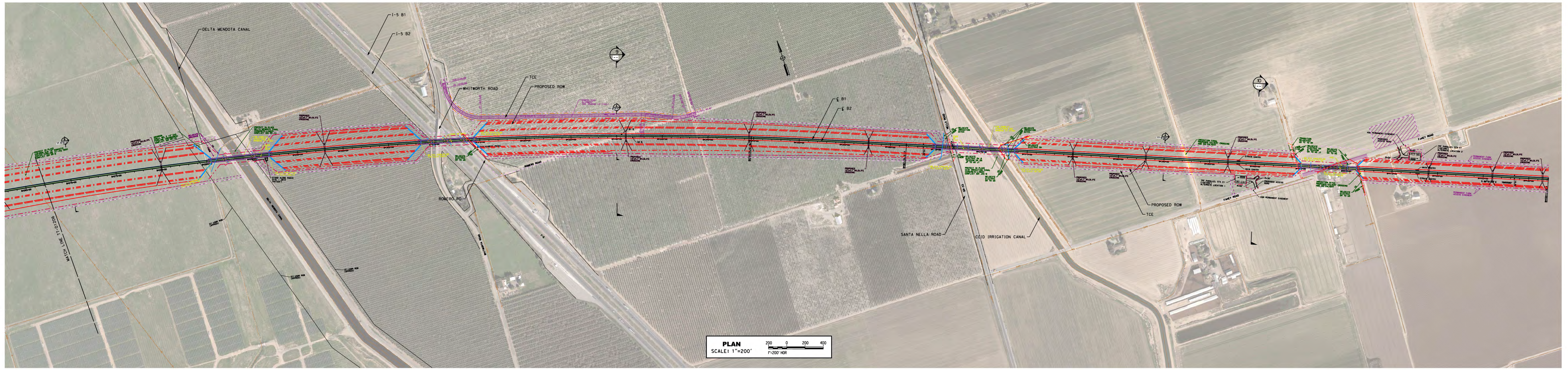

**PLAN**  
SCALE: 1"=200'  
200 0 200 400  
1"=200' HOR

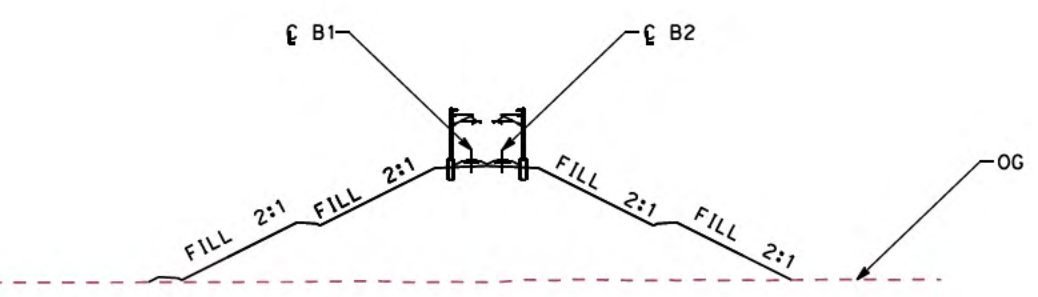

**9**  
**CROSS SECTION 4330+00**  
SCALE 1"=50'

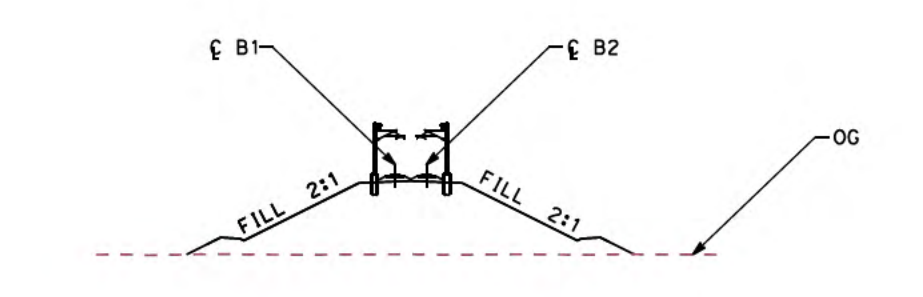

**10**  
**CROSS SECTION 4400+00**  
SCALE 1"=50'

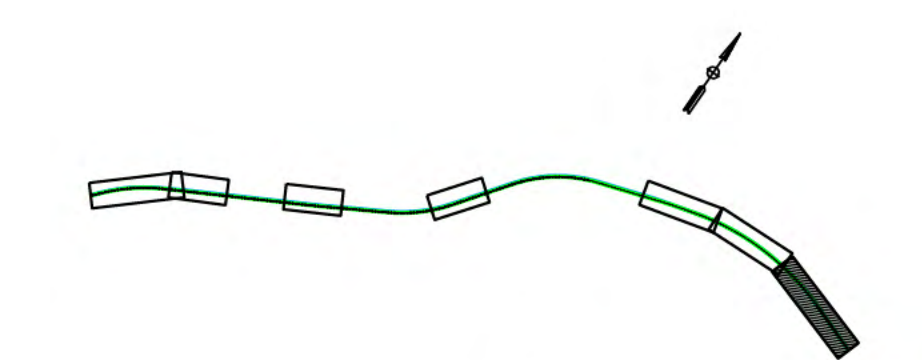

**SAN JOSE TO CVY EIR/S: VOLUME III**  
**ALTERNATIVE 3**  
**BOOK 3D**  
**SHEET 146 OF 237**

2021 RECORD SET P&ID NOVEMBER 30, 2021 NOT FOR CONSTRUCTION	<b>HNTB</b> 1111 Broadway 9th Floor Oakland, CA 94607	<b>CALIFORNIA</b> High-Speed Rail Authority	<b>CALIFORNIA HIGH-SPEED TRAIN PROJECT</b> SAN JOSE TO MERCED PACHECO PASS TUNNEL GRADING DETAIL	CONTRACT NO. HSR15-34 DRAWING NO. TN-D1413 SCALE AS SHOWN SHEET NO.
---	--	--	--	---

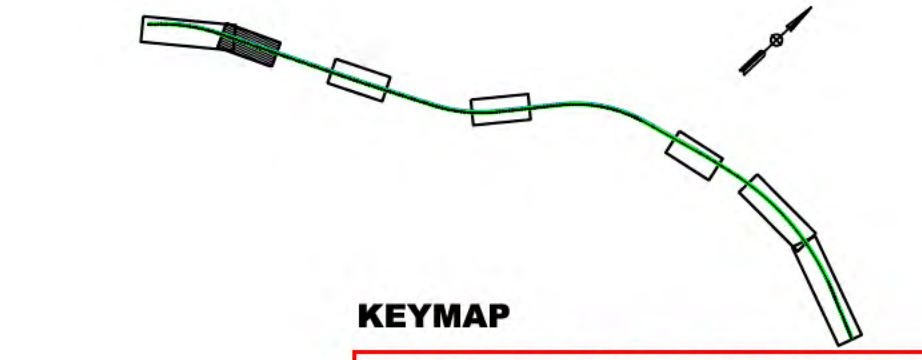
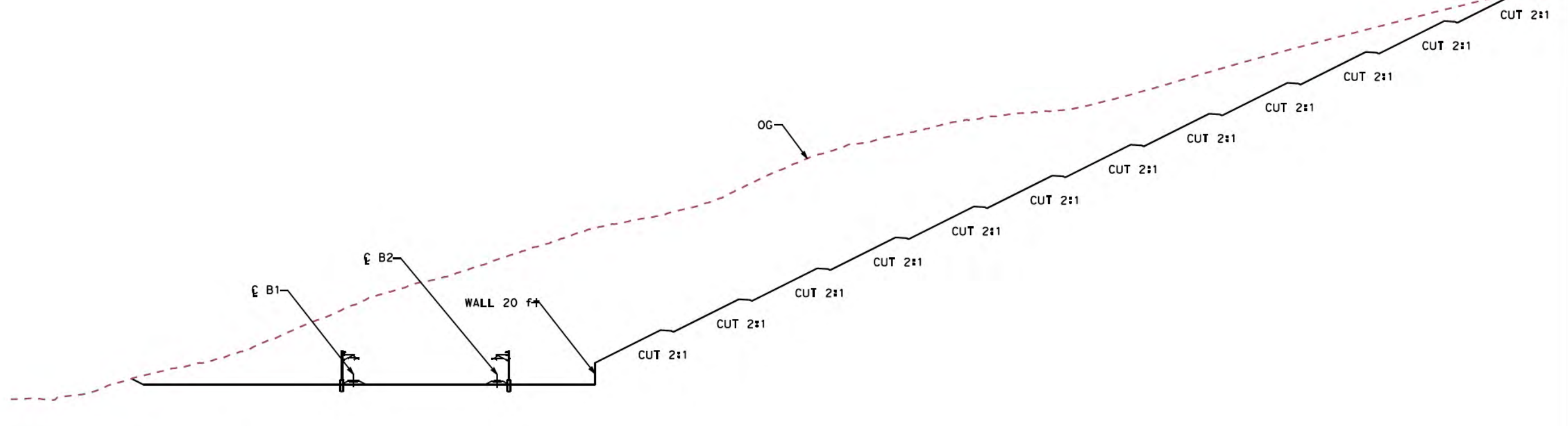
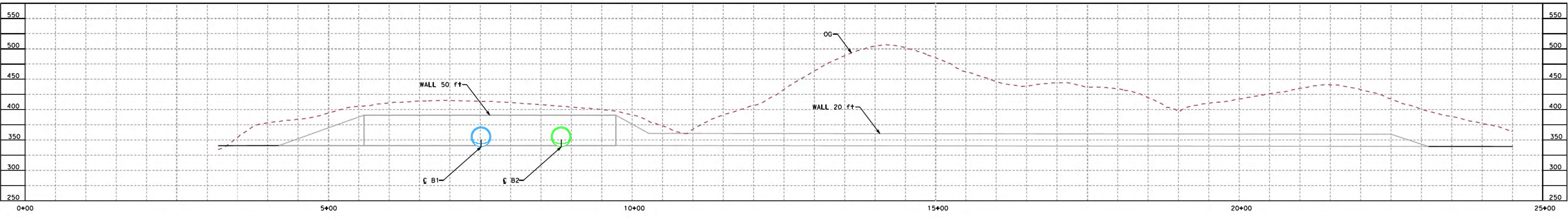
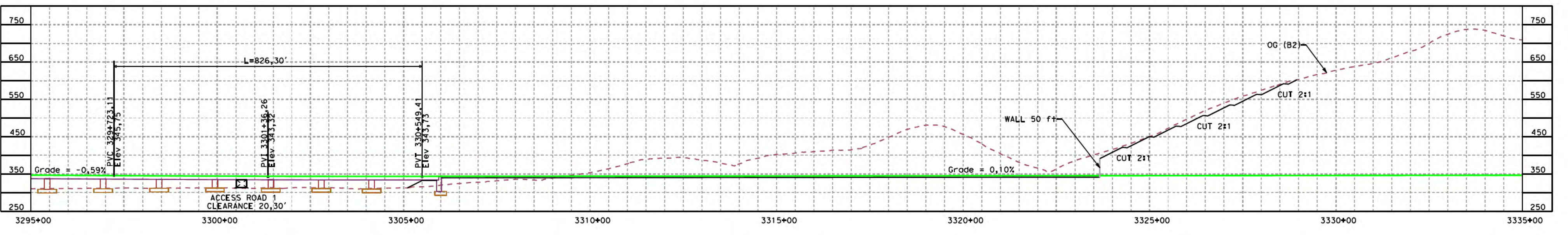
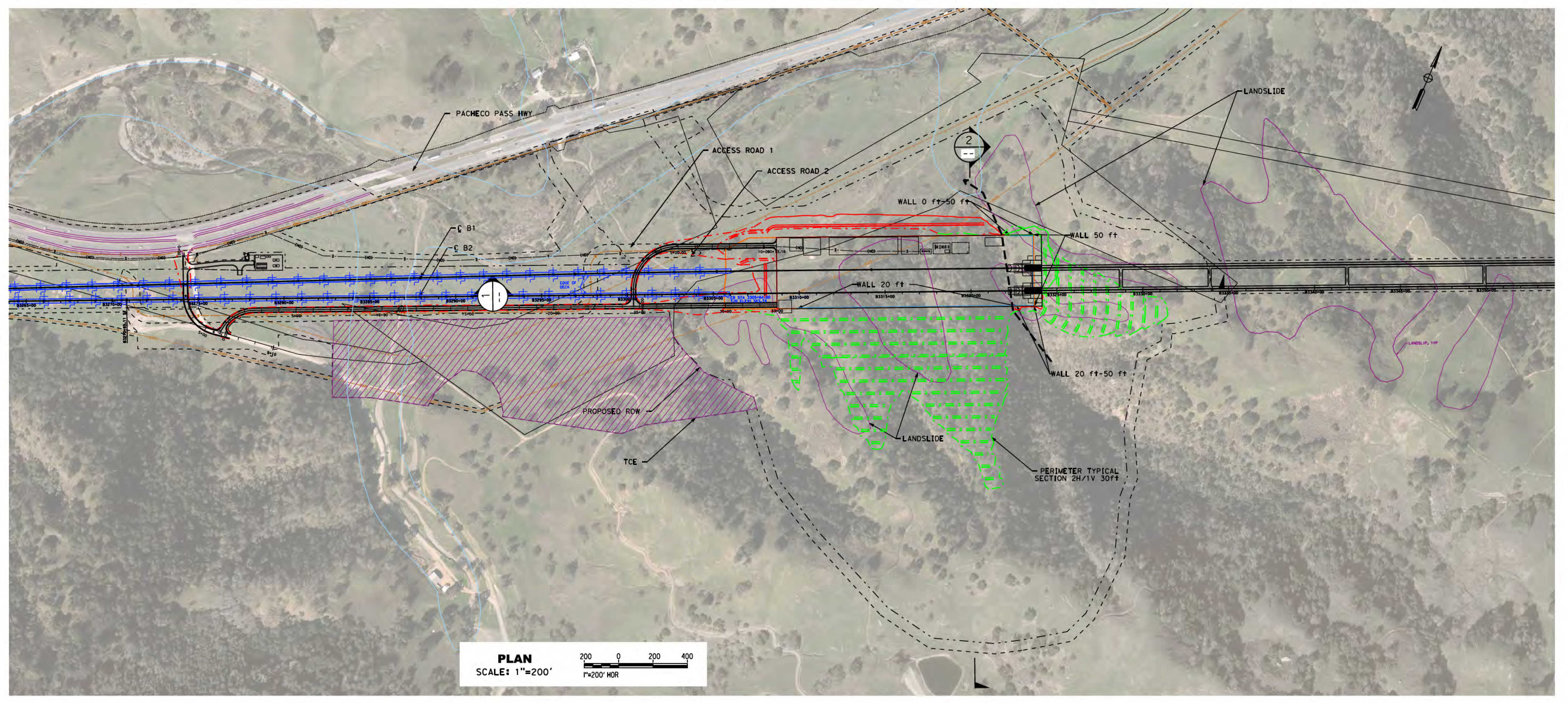

**SAN JOSE TO CVY EIRIS: VOLUME III**  
**ALTERNATIVE 3**  
**BOOK 3D**  
**SHEET 147 OF 237**

2021 RECORD SET PEPD NOVEMBER 30, 2021 NOT FOR CONSTRUCTION	<b>HNTB</b> 1111 Broadway 9th Floor Oakland, CA 94607		<b>CALIFORNIA HIGH-SPEED TRAIN PROJECT</b> <b>SAN JOSE TO MERCED</b> PACIFICO PASS TUNNEL TUNNEL 2 - PORTAL 1 SECTIONS	CONTRACT NO. HSR15-34 DRAWING NO. TN-D1414 SCALE AS SHOWN SHEET NO.
---	--	--	---	---



11/20/2021 09:51:42 AM C:\Users\jwheeler\Documents\2021\CA\_HSR\TND-01415.dwg C:\Users\jwheeler\Documents\2021\CA\_HSR\TND-01415.dwg  
 11/20/2021 09:51:42 AM C:\Users\jwheeler\Documents\2021\CA\_HSR\TND-01415.dwg C:\Users\jwheeler\Documents\2021\CA\_HSR\TND-01415.dwg  
 11/20/2021 09:51:42 AM C:\Users\jwheeler\Documents\2021\CA\_HSR\TND-01415.dwg C:\Users\jwheeler\Documents\2021\CA\_HSR\TND-01415.dwg

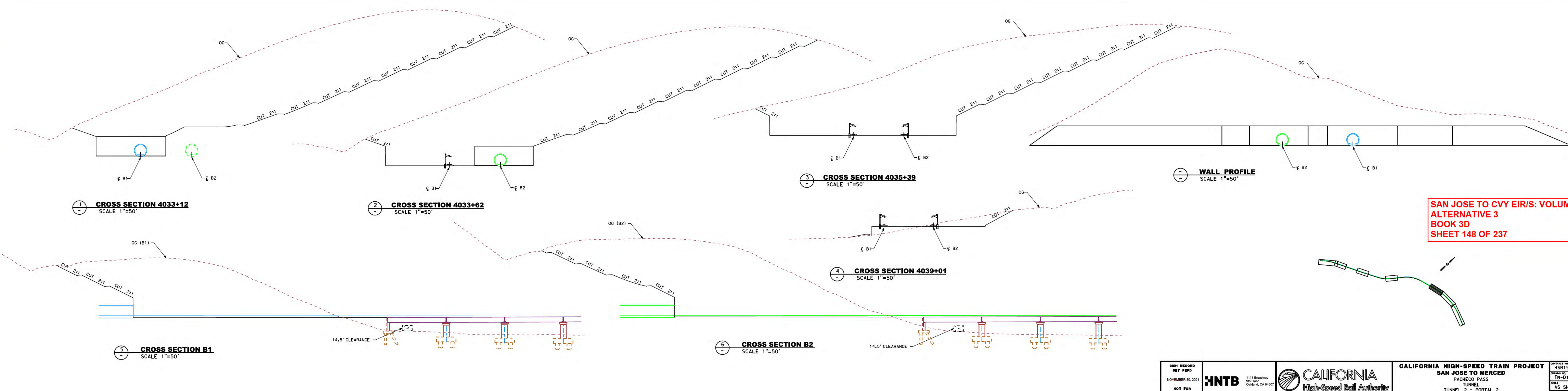
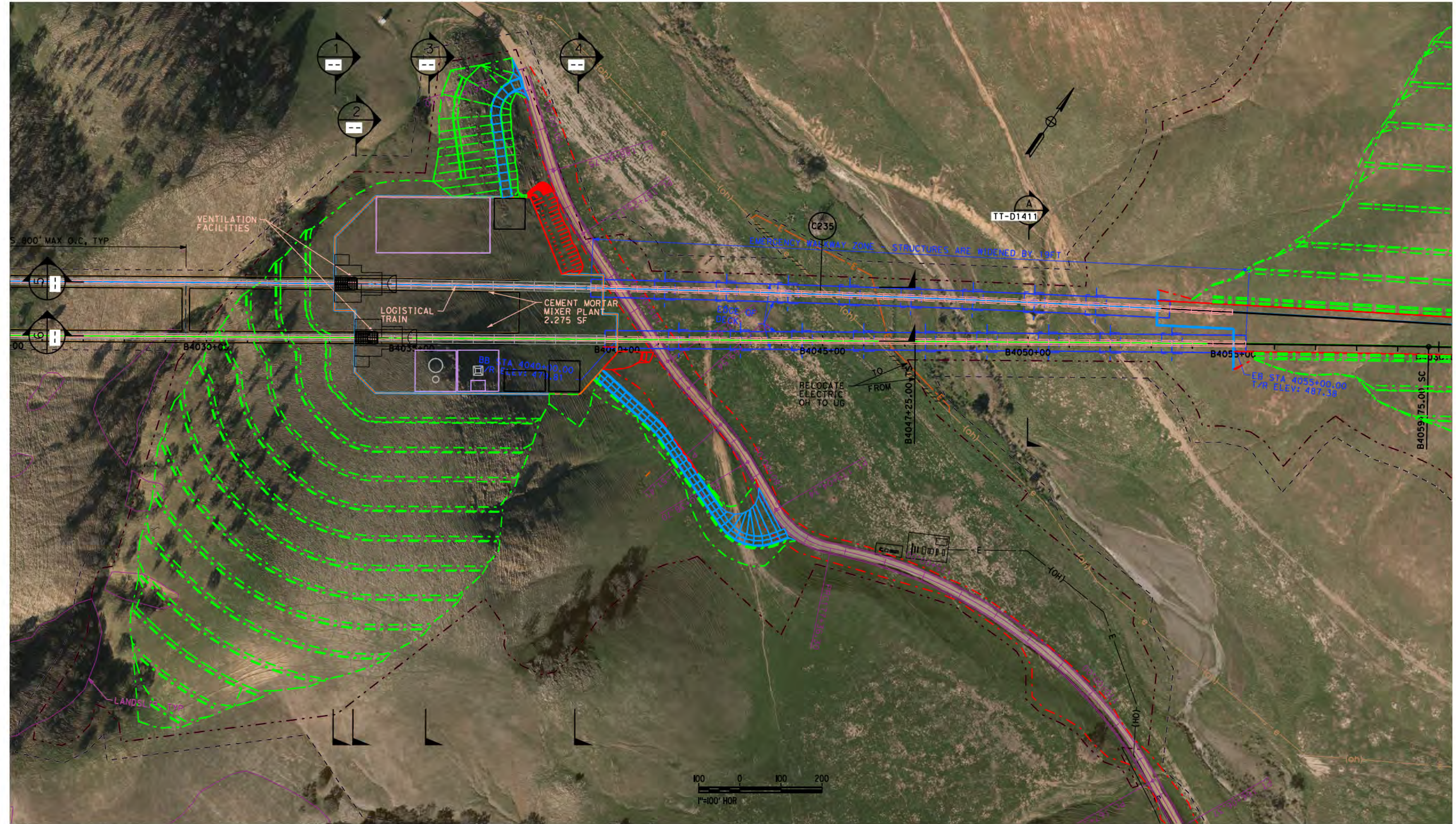

SAN JOSE TO CVY EIR/S: VOLUME III  
 ALTERNATIVE 3  
 BOOK 3D  
 SHEET 148 OF 237

2021 RECORD SET PERD NOVEMBER 30, 2021 NOT FOR CONSTRUCTION	<b>HNTB</b> <small>1111 Broadway 9th Floor Oakland, CA 94607</small>	 <b>CALIFORNIA</b> High-Speed Rail Authority	<b>CALIFORNIA HIGH-SPEED TRAIN PROJECT</b> <b>SAN JOSE TO MERCED</b> PACHECO PASS TUNNEL TUNNEL 2 - PORTAL 2 APPROACH 1	CONTRACT NO. HSR15-34 DRAWING NO. TN-D1415 SCALE AS SHOWN SHEET NO.
---	---	--	--	--

C:\pwworkspace\101712821\141646.dwg CALIBRE7.tbl C:\pwworkspace\101712821\141646.plt 11/27/2021 14:54:46 PM 416687.tbl C:\pwworkspace\101712821\141646.dwg C:\pwworkspace\101712821\141646.plt 11/27/2021 14:54:46 PM

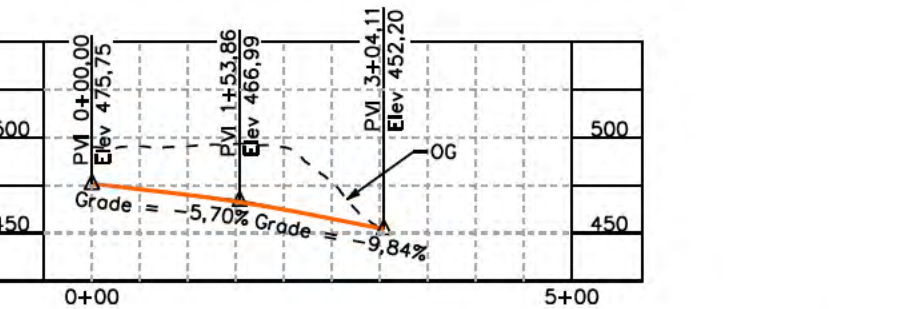
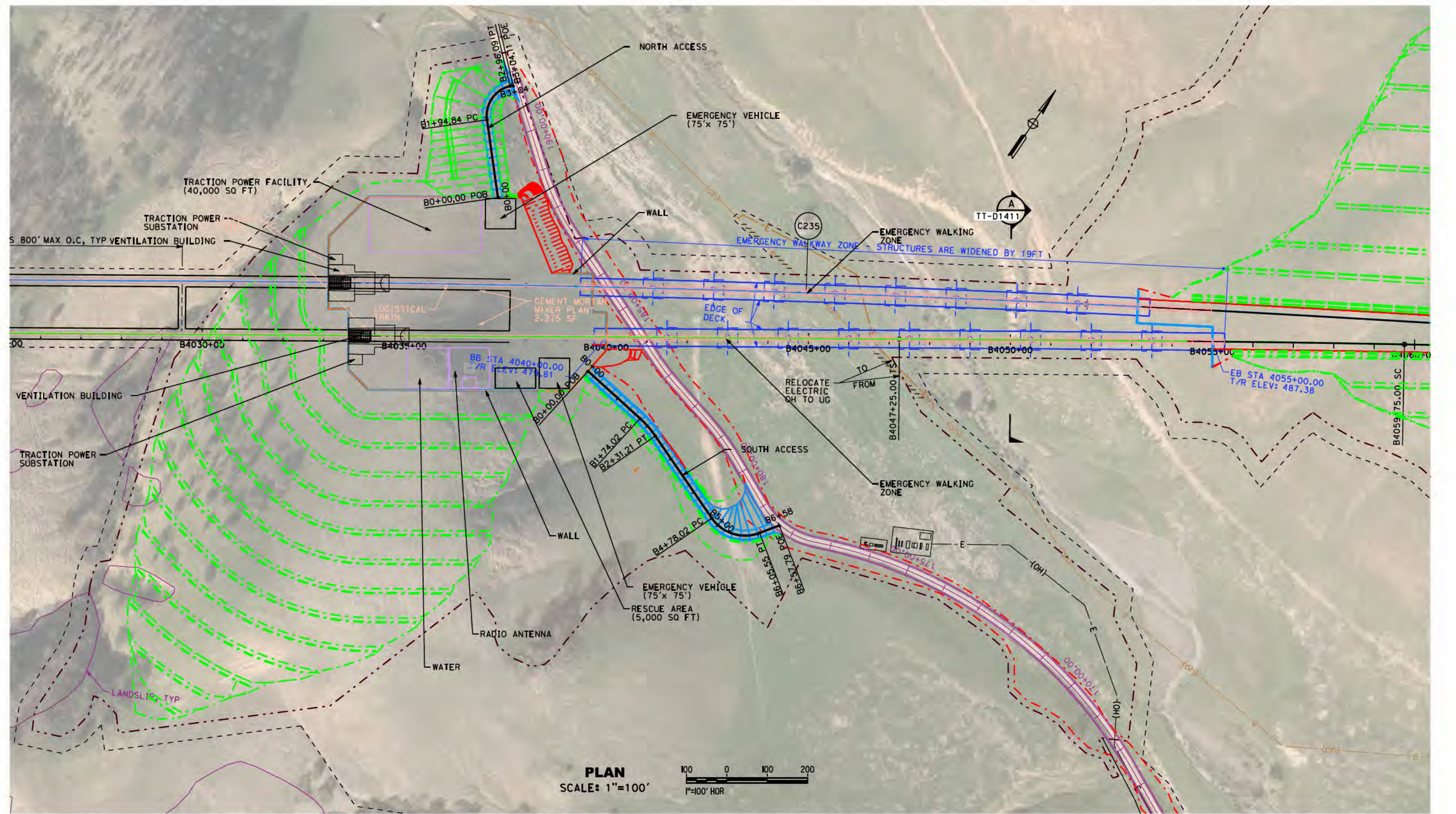

**NORTH ACCESS PROFILE**  
SCALE: 1"=100' HOR, 1"=50' VER

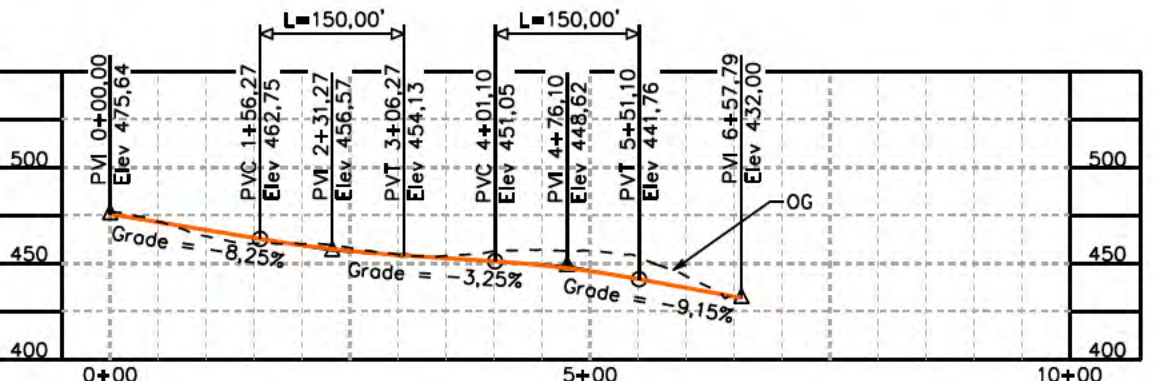

**SOUTH ACCESS PROFILE**  
SCALE: 1"=100' HOR, 1"=50' VER

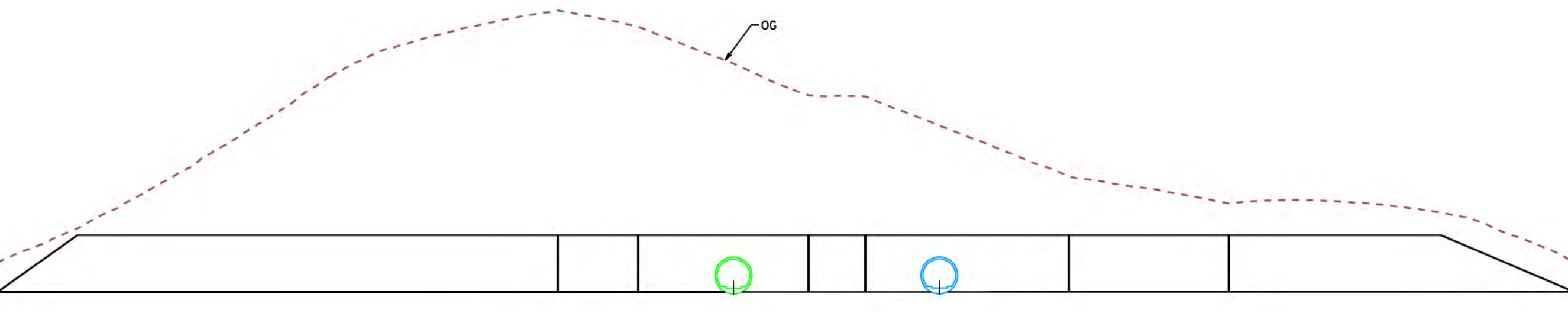

**WALL PROFILE**  
SCALE: 1"=50'

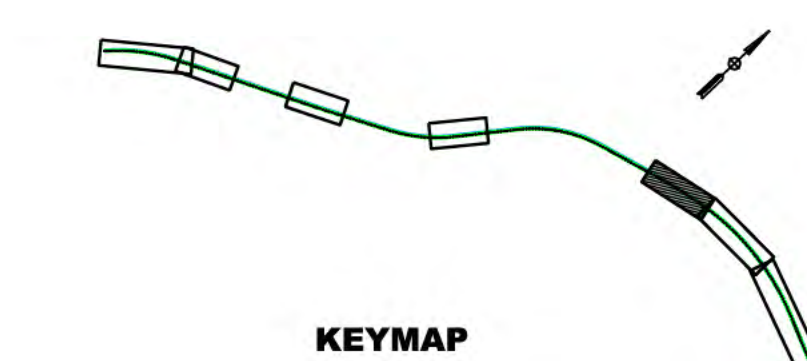

**SAN JOSE TO CVY EIR/S: VOLUME III  
ALTERNATIVE 3  
BOOK 3D  
SHEET 149 OF 237**